



MKS Type T3B Butterfly Valve With RS-232 Interface

Instruction Manual

2 Tech Drive, Suite 201
Andover, MA 01810-2449

Main: 978.975.2350
www.mksinst.com

137365-P1
RS-232 Interface
Rev 003

WARRANTY

Type T3B Butterfly Valve with RS-232 Interface

MKS Instruments, Inc. (MKS) warrants that for one (1) year from the date of shipment the equipment described above (the “equipment”) manufactured by MKS shall be free from defects in materials and workmanship.

For the period commencing with the date of shipment of this equipment and ending one (1) year later, MKS will, at its option, either repair or replace any part which is defective in materials or workmanship without charge to the purchaser. The foregoing shall constitute the exclusive and sole remedy of the purchaser for any breach of MKS of this warranty.

The purchaser, before returning any equipment covered by this warranty, which is asserted to be defective by the purchaser, shall make specific written arrangements with respect to the responsibility for shipping the equipment and handling any other incidental charges with the MKS Sales Representative or distributor from which the equipment was purchased or, in the case of a direct purchase from MKS, with the MKS home office in Andover, Massachusetts, USA.

This warranty does not apply to any equipment which has not been installed and used in accordance with the specifications recommended by MKS for the proper and normal use of the equipment. MKS shall not be liable under any circumstances for indirect, special, consequential, or incidental damages in connection with, or arising out of, the sale, performance, or use of the equipment covered by this warranty.

MKS recommends that all MKS pressure and flow products be calibrated periodically (typically every 6 to 12 months) to ensure accurate readings. When a product is returned to MKS for this periodic re-calibration it is considered normal preventative maintenance not covered by any warranty.

THIS WARRANTY IS IN LIEU OF ALL OTHER RELEVANT WARRANTIES, EXPRESSED OR IMPLIED, INCLUDING THE IMPLIED WARRANTY OF MERCHANTABILITY AND THE IMPLIED WARRANTY OF FITNESS FOR A PARTICULAR PURPOSE, AND ANY WARRANTY AGAINST INFRINGEMENT OF ANY PATENT.

**MKS Type T3B
Butterfly Valve
With RS-232 Interface**

Copyright © 2011 by MKS Instruments, Inc.

All rights reserved. No part of this work may be reproduced or transmitted in any form or by any means, electronic or mechanical, including photocopying and recording, or by any information storage or retrieval system, except as may be expressly permitted in writing by MKS Instruments, Inc.

Printed in the United States of America

DeviceNet™ is a trademark of Open DeviceNet Vendor Association, Inc., Coral Springs, FL.

SEMI® is a registered trademark of Semiconductor Equipment and Materials International, Mountain View, CA.

Swagelok® and VCR® are registered trademark of Swagelok Marketing Co., Solon, OH.

Firmware version: 01.02

Table of Contents

Valve Safety Information	1
Symbols Used in This Instruction Manual	1
Symbols Found on the Unit	1
Safety Procedures and Precautions	1
Sicherheitshinweise für das Ventil.....	3
In dieser Betriebsanleitung vorkommende Symbole	3
Erklärung der am Gerät angebrachten Symbole	3
Sicherheitsvorschriften und Vorsichtsmaßnahmen	3
Informations de sécurité relatives au manomètre.....	5
Symboles utilisés dans ce manuel d'utilisation	5
Symboles figurant sur l'unité	5
Mesures de sécurité et précautions	5
Medidas de seguridad del manómetro	7
Símbolos usados en este manual de instrucciones	7
Símbolos hallados en la unidad	7
Procedimientos y precauciones de seguridad	7
Chapter One: General Information	9
Introduction	9
How This Manual is Organized.....	10
Customer Support.....	10
Chapter Two: Installation.....	11
Unpacking the Type T3B Unit	11
Interface Cables.....	11
Product Location and Requirements.....	13
Setup.....	14
Electrical Information.....	15
Startup	19
Chapter Three: Product Overview.....	21
General Information	21
Control Mode	21
Trip Points	26
Top Panel Components.....	28
Labels	30
Chapter Four: Maintenance and Troubleshooting.....	31
General Information	31
Maintenance	31
Troubleshooting.....	31
Appendix A: Product Specifications	33
Appendix B: Model Code Explanation	35
Model Code	35
Appendix C: Dimensions	37
Index.....	43

List of Figures

Figure 1: Preferred Method To Connect an Overall Metal Braided Shielded Cable.....	12
Figure 2: Alternate Method To Connect an Overall Metal Braided Shielded Cable.....	13
Figure 3: Typical System Configuration	14
Figure 4: Top Panel of the T3B Unit.....	15
Figure 5: Typical Pressure Response in LEARN Mode.....	23
Figure 6. Typical Chamber Pump Speed Curve	23
Figure 7: Phase Set Too High.....	24
Figure 8: Phase Set Too Low	24
Figure 9: Gain Set Too High	25
Figure 10: Gain Set Too Low	25
Figure 11: Trip Point Direction Set Low.....	27
Figure 12: Trip Point Direction Set High	27
Figure 13: Top Panel of the T3B Unit.....	28
Figure 14: Pump Label.....	30
Figure 15: Serial Number Label.....	30

List of Tables

Table 1: Definition of Symbols Found on the Unit.....	1
Tabelle 2: Bedeutung der am Gerät angebrachten Symbole	3
Tableau 3: Définition des symboles sur l'unité.....	5
Tabla 4: Definición de los símbolos hallados en la unidad	7
Table 5: Definitions.....	9
Table 6: Auxiliary Connector Pin Out.....	16
Table 7: Analog Sensor 1 (High) Connector Pin Out.....	17
Table 8: Analog Sensor 2 (Low) Connector Pin Out	18
Table 9: External Power Connector Pin Out	18
Table 10: Position Status LED Indicators	29
Table 11: Pressure Status LED Indicators.....	29

Valve Safety Information

Symbols Used in This Instruction Manual

Definitions of WARNING, CAUTION, and NOTE messages used throughout the manual are:



Warning

The **WARNING** sign denotes a hazard. It calls attention to a procedure, practice, condition, or the like, which, if not correctly performed or adhered to, could result in injury to personnel.



Caution

The **CAUTION** sign denotes a hazard. It calls attention to an operating procedure, practice, or the like, which, if not correctly performed or adhered to, could result in damage to or destruction of all or part of the product.



















Note

The **NOTE** sign denotes important information. It calls attention to a procedure, practice, condition, or the like, which is essential to highlight.

Symbols Found on the Unit

The following table describes symbols that may be found on the unit.

Table 1: Definition of Symbols Found on the Unit

 On (Supply) IEC 417, No. 5007	 Off (Supply) IEC 417, No. 5008	 Earth (ground) IEC 417, No. 5017	 Protective Earth (ground) IEC 417, No. 5019
 Frame or Chassis IEC 417, No. 5020	 Equipotentiality IEC 417, No. 5021	 Direct Current IEC 417, No. 5031	 Alternating Current IEC 417, No. 5032
 Both Direct and Alternating Current IEC 417, No. 5033-a	 Class II Equipment IEC 417, No. 5172-a	 Three Phase Alternating Current IEC 617-2, No. 020206	 Caution, Hand Crush ISO 3864
 Caution (refer to accompanying documents) ISO 3864, No. B.3.1	 Caution, Risk of Electric Shock ISO 3864, No. B.3.6	 Caution, Hot Surface IEC 417, No. 5041	 Caution, Spring Loaded ISO 3864

Safety Procedures and Precautions

Observe the following general safety precautions during all phases of operation of this instrument. Failure to comply with these precautions or with specific warnings elsewhere in this manual violates safety standards of intended use of the instrument and may impair the protection provided by the equipment. MKS Instruments, Inc. assumes no liability for the customer's failure to comply with these requirements.



Warning

Moving parts in the valve create a risk of personal injury until the valve is securely incorporated into a system. To avoid injury, keep all body parts away from any valve opening.

- 1. Do not insert objects into openings where contact with moving parts is possible.**
 - 2. Isolate the valve from any electrical or pneumatic power supply before handling the valve.**
-

DO NOT SUBSTITUTE PARTS OR MODIFY VALVE

Do not install substitute parts or perform any unauthorized modification to the valve. Return the valve to an MKS Calibration and Service Center for service and repair to ensure that all safety features are maintained.

SERVICE BY QUALIFIED PERSONNEL ONLY

Operating personnel must not attempt component replacement and internal adjustments. Qualified service personnel must perform any service only.

USE CAUTION WHEN OPERATING WITH HAZARDOUS MATERIALS

If hazardous materials are used, observe the proper safety precautions, completely purge the valve when necessary, and ensure that the material used is compatible with the wetted materials in this product, including any sealing materials.

PURGE THE VALVE

After installing the unit, or before removing it from a system, purge the unit completely with a clean, dry gas to eliminate all traces of the previously used flow material.

USE PROPER PROCEDURES WHEN PURGING

This valve must be purged under a ventilation hood and gloves must be worn for protection.

DO NOT OPERATE IN AN EXPLOSIVE ENVIRONMENT

To avoid explosion, do not operate this product in an explosive environment unless it has been specifically certified for such operation.

USE PROPER FITTINGS AND TIGHTENING PROCEDURES

All valve fittings must be consistent with valve specifications and compatible with the intended use of the valve. Assemble and tighten fittings according to manufacturer's directions.

CHECK FOR LEAK-TIGHT FITTINGS

Carefully check all vacuum component connections to ensure leak-tight installation.

OPERATE AT SAFE INLET PRESSURES

Never operate the valve at pressures higher than the rated maximum pressure (refer to the product specifications for the maximum allowable pressure).

INSTALL A SUITABLE BURST DISC

When operating from a pressurized gas source, install a suitable burst disc in the vacuum system to prevent system explosion should the system pressure rise.

KEEP THE UNIT FREE OF CONTAMINANTS

Do not allow contaminants to enter the unit before or during use. Contamination such as dust, dirt, lint, glass chips, and metal chips may permanently damage the unit or contaminate the process.

KEEP AWAY FROM VALVE OPENING

Keep fingers, other body parts, and other materials away from the valve opening when the valve is in operation.

Sicherheitshinweise für das Ventil

In dieser Betriebsanleitung vorkommende Symbole

Bedeutung der mit WARNUNG!, VORSICHT! und HINWEIS gekennzeichneten Absätze in dieser Betriebsanleitung.



Warnung!

Das Symbol **WARNUNG!** weist auf eine Gefahr für das Bedienpersonal hin. Es macht auf einen Arbeitsablauf, eine Arbeitsweise, einen Zustand oder eine sonstige Gegebenheit aufmerksam, deren unsachgemäße Ausführung bzw. ungenügende Berücksichtigung zu Verletzungen führen kann.



Vorsicht!

Das Symbol **VORSICHT!** weist auf eine Gefahr für das Gerät hin. Es macht auf einen Bedienungsablauf, eine Arbeitsweise oder eine sonstige Gegebenheit aufmerksam, deren unsachgemäße Ausführung bzw. ungenügende Berücksichtigung zu einer Beschädigung oder Zerstörung des Gerätes oder von Teilen des Gerätes führen kann.



















Hinweis

Das Symbol **HINWEIS** macht auf wichtige Informationen bezüglich eines Arbeitsablaufs, einer Arbeitsweise, eines Zustands oder einer sonstige Gegebenheit aufmerksam.

Erklärung der am Gerät angebrachten Symbole

Nachstehender Tabelle sind die Bedeutungen der Symbole zu entnehmen, die am Gerät angebracht sein können.

Tabelle 2: Bedeutung der am Gerät angebrachten Symbole

 Ein (Energie) IEC 417, No.5007	 Aus (Energie) IEC 417, No.5008	 Erdanschluss IEC 417, No.5017	 Schutzleiteranschluss IEC 417, No.5019
 Masseanschluss IEC 417, No.5020	 Equipotentialanschluss IEC 417, No.5021	 Gleichstrom IEC 417, No.5031	 Wechselstrom IEC 417, No.5032
 Gleich- oder Wechselstrom IEC 417, No.5033-a	 Durchgängige doppelte oder verstärkte Isolierung IEC 417, No.5172-a	 Dreileiter-Wechselstrom (Drehstrom) IEC 617-2, No.020206	 Vorsicht: Quetschgefahr für die Hand ISO 3864
 Warnung vor einer Gefahrenstelle (Achtung, Dokumentation beachten) ISO 3864, No.B.3.1	 Warnung vor gefährlicher elektrischer Spannung ISO 3864, No.B.3.6	 Höhere Temperatur an leicht zugänglichen Teilen IEC 417, No.5041	 Vorsicht: Federspannung ISO 3864

Sicherheitsvorschriften und Vorsichtsmaßnahmen

Folgende allgemeine Sicherheitsvorschriften sind während allen Betriebsphasen dieses Gerätes zu befolgen. Eine Missachtung der Sicherheitsvorschriften und sonstiger Warnhinweise in dieser

Betriebsanleitung verletzt die für dieses Gerät und seine Bedienung geltenden Sicherheitsstandards, und kann die Schutzvorrichtungen an diesem Gerät wirkungslos machen. MKS Instruments, Inc. haftet nicht für Missachtung dieser Sicherheitsvorschriften seitens des Kunden.



Warnung

Solange das Ventil nicht fest in ein System eingebaut ist, besteht Verletzungsgefahr aufgrund von beweglichen Teilen. Daher Finger und andere Körperteile unbedingt von allen Ventilöffnungen fernhalten.

- 1. Niemals Fremdkörper in Öffnungen einführen, in denen ein Kontakt mit beweglichen Teilen möglich ist.**
 - 2. Das Ventil vor dem Hantieren stets von allen elektrischen und pneumatischen Kraftquellen trennen.**
-

Niemals Teile austauschen oder Änderungen am Ventil vornehmen!

Ersetzen Sie keine Teile mit baugleichen oder ähnlichen Teilen, und nehmen Sie keine eigenmächtigen Änderungen am Ventil vor. Schicken Sie das Ventil zwecks Wartung und Reparatur an den MKS-Kalibrierungs- und -Kundendienst ein. Nur so wird sichergestellt, daß alle Schutzvorrichtungen voll funktionsfähig bleiben.

Wartung nur durch qualifizierte Fachleute!

Das Auswechseln von Komponenten und das Vornehmen von internen Einstellungen darf nur von qualifizierten Fachleuten durchgeführt werden, niemals vom Bedienpersonal.

Vorsicht beim Arbeiten mit gefährlichen Stoffen!

Wenn gefährliche Stoffe verwendet werden, muß der Bediener die entsprechenden Sicherheitsvorschriften genauestens einhalten, das Ventil, falls erforderlich, vollständig spülen, sowie sicherstellen, daß der Gefahrstoff die von ihm benetzten, im Ventil verwendeten Materialien, insbesondere Dichtungen, nicht angreift.

Spülen des Ventils mit Gas!

Nach dem Installieren oder vor dem Ausbau aus einem System muß das Ventil unter Einsatz eines reinen Trockengases vollständig gespült werden, um alle Rückstände des Vorgängermediums zu entfernen.

Anweisungen zum Spülen des Ventils!

Das Ventil darf nur unter einer Ablufthaube gespült werden. Schutzhandschuhe sind zu tragen.

Nicht zusammen mit explosiven Stoffen, Gasen oder Dämpfen benutzen!

Um der Gefahr einer Explosion vorzubeugen, darf dieses Produkt niemals zusammen mit explosiven Stoffe aller Art eingesetzt werden, sofern es nicht ausdrücklich für diesen Zweck zugelassen ist.

Anweisungen zum Installieren der Armaturen!

Alle Ventilanschlußstücke und Armaturenteile müssen mit den Ventilspezifikationen übereinstimmen, und mit dem geplanten Einsatz des Ventils kompatibel sein. Der Einbau, insbesondere das Anziehen und Abdichten, muß gemäß den Anweisungen des Herstellers vorgenommen werden.

Ventil auf Undichtigkeiten prüfen!

Überprüfen Sie sorgfältig alle Verbindungen auf undichte Stellen.

Nur unter zulässigen Anschlußdrücken betreiben!

Betreiben Sie das Ventil niemals unter Drücken, die den maximal zulässigen Druck (siehe Produktspezifikationen) übersteigen.

Geeignete Berstscheibe installieren!

Wenn mit einer unter Druck stehenden Gasquelle gearbeitet wird, sollte eine geeignete Berstscheibe in das Vakuumsystem installiert werden, um eine Explosionsgefahr aufgrund von steigendem Systemdruck zu vermeiden.

Verunreinigungen vermeiden!

Stellen Sie sicher, daß Verunreinigungen jeglicher Art weder vor dem Einsatz noch während des Betriebs in das Innere gelangen können. Staub- und Schmutzpartikel, Glassplitter oder Metallspäne können das Produkt dauerhaft beschädigen oder Prozeß und Meßwerte verfälschen.

Hände weg von der Ventilöffnung!

Körperteile, insbesondere Finger, sowie Fremdobjekte während des Betriebes von der Ventilöffnung fernhalten.

Informations de sécurité relatives au manomètre

Symboles utilisés dans ce manuel d'utilisation

Définitions des indications AVERTISSEMENT, ATTENTION, et REMARQUE utilisées dans ce manuel.



Avertissement

L'indication **AVERTISSEMENT** signale un danger pour le personnel. Elle attire l'attention sur une procédure, une pratique, une condition, ou toute autre situation présentant un risque d'accident pour le personnel, en cas d'exécution incorrecte ou de non-respect des consignes.



Attention

L'indication **ATTENTION** signale un danger pour l'appareil. Elle attire l'attention sur une procédure d'exploitation, une pratique, ou toute autre situation, présentant un risque de dégât ou de destruction partielle ou totale du produit, en cas d'exécution incorrecte ou de non-respect des consignes.



















Remarque

L'indication **REMARQUE** signale une information importante. Elle attire l'attention sur une procédure, une pratique, une condition, ou toute autre situation, présentant un intérêt particulier.

Symboles figurant sur l'unité

Le tableau suivant décrit les symboles pouvant apparaître sur l'unité.

Tableau 3: Définition des symboles sur l'unité

 Marche (sous tension) IEC 417, No.5007	 Arrêt (hors tension) IEC 417, No.5008	 Terre (masse) IEC 417, No.5017	 Terre de protection (masse) IEC 417, No.5019
 Masse IEC 417, No.5020	 Equipotentialité IEC 417, No.5021	 Courant continu IEC 417, No.5031	 Courant alternatif IEC 417, No.5032
 Courant continu et alternatif IEC 417, No.5033-a	 Matériel de classe II IEC 417, No.5172-a	 Courant alternatif triphasé IEC 617-2, No.020206	 Attention : Danger d'écrasement de la main ISO 3864
 Attention : se reporter à la documentation ISO 3864, No.B.3.1	 Attention : risque de choc électrique ISO 3864, No.B.3.6	 Attention : surface brûlante IEC 417, No.5041	 Attention : Ce dispositif est à ressort ISO 3864

Mesures de sécurité et précautions

Observer les précautions générales de sécurité suivantes pendant toutes les phases d'exploitation de cet appareil. Le non-respect des ces précautions ou des avertissements du manuel constitue une violation des normes de sécurité relatives à l'utilisation de l'appareil et peut compromettre la protection assurée

par l'appareil. MKS Instruments, Inc. rejette toute responsabilité en cas de non-respect des consignes par les clients.



Avertissement

Les pièces mobiles de la valve peuvent être une cause d'accident tant que la valve n'est pas solidement incorporée dans un système. Pour éviter tout accident, tenir toute partie du corps à distance de toute ouverture de la valve.

- 1. Ne pas insérer des objets dans les ouvertures où le contact avec des pièces mobiles est possible.**
 - 2. Isoler la valve de toute source d'alimentation électrique ou pneumatique pendant la manipulation de la valve.**
-

PAS DE SUBSTITUTION DE PIÈCES OU DE MODIFICATION DE LA VALVE

Ne pas installer des pièces de substitution ou effectuer des modifications non autorisées sur la valve. Renvoyer la valve à un centre de service et de calibrage MKS pour tout dépannage ou réparation afin de garantir le l'intégrité des dispositifs de sécurité.

DÉPANNAGE UNIQUEMENT PAR DU PERSONNEL QUALIFIÉ

Le personnel d'exploitation ne doit pas essayer de remplacer des composants ou de faire des réglages internes. Tout dépannage doit être uniquement effectué par du personnel qualifié.

PRÉCAUTION EN CAS D'UTILISATION AVEC DES PRODUITS DANGEREUX

Si des produits dangereux sont utilisés, prendre les mesures de précaution appropriées, purger complètement la valve quand cela est nécessaire, et s'assurer que les produits utilisés sont compatibles avec les composants liquides de l'appareil, y compris les matériaux d'étanchéité.

PURGE DE LA VALVE

Après l'installation de l'unité, ou avant son enlèvement d'un système, purger l'unité complètement avec un gaz propre et sec afin d'éliminer toute trace du produit de flux utilisé précédemment.

UTILISATION DES PROCÉDURES APPROPRIÉES POUR LA PURGE

Cette valve doit être purgée sous une hotte de ventilation, et il faut porter des gants de protection.

PAS D'EXPLOITATION DANS UN ENVIRONNEMENT EXPLOSIF

Pour éviter toute explosion, ne pas utiliser cet appareil dans un environnement explosif, sauf en cas d'homologation spécifique pour une telle exploitation.

UTILISATION D'ÉQUIPEMENTS APPROPRIÉS ET PROCÉDURES DE SERRAGE

Tous les équipements de la valve doivent être cohérents avec ses spécifications, et compatibles avec l'utilisation prévue de la valve. Assembler et serrer les équipements conformément aux directives du fabricant.

VÉRIFICATION DE L'ÉTANCHÉITÉ DES CONNEXIONS

Vérifier attentivement toutes les connexions des composants pour le vide afin de garantir l'étanchéité de l'installation.

EXPLOITATION AVEC DES PRESSIONS D'ENTRÉE NON DANGEREUSES

Ne jamais utiliser la valve avec des pressions supérieures à la pression nominale maximum (se reporter aux spécifications de l'unité pour la pression maximum admissible).

INSTALLATION D'UN DISQUE D'ÉCHAPPEMENT ADAPTÉ

En cas d'exploitation avec une source de gaz pressurisé, installer un disque d'échappement adapté dans le système à vide afin d'éviter une explosion du système en cas d'augmentation de la pression.

MAINTIEN DE L'UNITÉ À L'ABRI DES CONTAMINATIONS

Ne pas laisser des produits contaminants pénétrer dans l'unité avant ou pendant l'utilisation. Des produits contaminants tels que des poussières et des fragments de tissu, de glace et de métal peuvent endommager l'unité d'une manière permanente ou contaminer le processus.

PRÉCAUTION AVEC L'OUVERTURE DE LA VALVE

Éviter tout contact des mains, toute autre partie du corps, ou tout autre matériel avec l'ouverture de la valve quand celle-ci est en fonctionnement.

Medidas de seguridad del manómetro

Símbolos usados en este manual de instrucciones

Definiciones de los mensajes de advertencia, precaución y de las notas usados en el manual.



Advertencia

El símbolo de advertencia indica la posibilidad de que se produzcan daños personales. Pone de relieve un procedimiento, práctica, estado, etc. que en caso de no realizarse o cumplirse correctamente puede causar daños personales.



Precaución

El símbolo de precaución indica la posibilidad de producir daños al equipo. Pone de relieve un procedimiento operativo, práctica, etc. que en caso de no realizarse o cumplirse correctamente puede causar daños o la destrucción total o parcial del equipo.



















Nota

El símbolo de notas indica información de importancia. Este símbolo pone de relieve un procedimiento, práctica o condición cuyo conocimiento es esencial destacar.

Símbolos hallados en la unidad

La tabla siguiente contiene los símbolos que puede hallar en la unidad.

Tabla 4: Definición de los símbolos hallados en la unidad

 Encendido (alimentación eléctrica) IEC 417, N° 5007	 Apagado (alimentación eléctrica) IEC 417, N° 5008	 Puesta a tierra IEC 417, N° 5017	 Protección a tierra IEC 417, N° 5019
 Caja o chasis IEC 417, N° 5020	 Equipotencialidad IEC 417, N° 5021	 Corriente continua IEC 417, N° 5031	 Corriente alterna IEC 417, N° 5032
 Corriente continua y alterna IEC 417, N° 5033-a	 Equipo de clase II IEC 417, N° 5172-a	 Corriente alterna trifásica IEC 617-2, N° 020206	 Precaución. Peligro de aplastamiento de la mano ISO 3864
 Precaución. Consulte los documentos adjuntos ISO 3864, N° B.3.1	 Precaución. Riesgo de descarga eléctrica ISO 3864, N° B.3.6	 Precaución. Superficie caliente IEC 417, N° 5041	 Precaución. Dispositivo a presión ISO 3864

Procedimientos y precauciones de seguridad

Las medidas generales de seguridad descritas a continuación deben observarse durante todas las etapas de funcionamiento del instrumento. La falta de cumplimiento de dichas medidas de seguridad o de las advertencias específicas a las que se hace referencia en otras partes de este manual, constituye una violación de las normas de seguridad establecidas para el uso previsto del instrumento y podría anular

la protección proporcionada por el equipo. Si el cliente no cumple dichas precauciones y advertencias, MKS Instruments, Inc. no asume responsabilidad legal alguna.



Advertencia

Hasta que la válvula sea incorporada en forma segura al sistema, las piezas en movimiento presentes en la misma pueden causar daños personales. Para evitarlo, mantenga todo el cuerpo alejado de la abertura de válvula.

1. No introduzca por las aberturas objetos que puedan entrar en contacto con piezas en movimiento.
 2. Antes de tocar la válvula, aíslala de toda fuente de alimentación neumática o eléctrica.
-

NO UTILICE PIEZAS NO ORIGINALES O MODIFIQUE LA VÁLVULA

No instale piezas que no sean originales o modifique la válvula sin autorización. Para asegurar el correcto funcionamiento de todos los dispositivos de seguridad, envíe la válvula al Centro de servicio y calibración de MKS toda vez que sea necesario efectuar reparaciones o tareas de mantenimiento.

LAS REPARACIONES DEBEN SER EFECTUADAS ÚNICAMENTE POR TÉCNICOS AUTORIZADOS

Los operarios no deben intentar reemplazar los componentes o realizar tareas de ajuste en el interior. Las tareas de mantenimiento o reparación deben ser realizadas únicamente por personal autorizado.

TENGA CUIDADO CUANDO TRABAJE CON MATERIALES TÓXICOS

Cuando se utilicen materiales tóxicos, los operarios deberán cumplir las medidas de seguridad correspondientes, purgar totalmente la válvula cuando sea necesario y comprobar que el material utilizado sea compatible con los materiales humedecidos del instrumento e inclusive, con los materiales de sellado.

PURGUE LA VÁLVULA

Una vez instalada la unidad o antes de retirarla del sistema, purgue completamente la unidad con gas limpio y seco para eliminar todo resto de la sustancia líquida empleada anteriormente.

USE PROCEDIMIENTOS ADECUADOS PARA REALIZAR LA PURGA

La válvula debe purgarse debajo de una campana de ventilación y deben utilizarse guantes protectores.

NO HAGA FUNCIONAR LA VÁLVULA EN UN AMBIENTE CON RIESGO DE EXPLOSIONES

Para evitar que se produzcan explosiones, no haga funcionar este producto en un ambiente con riesgo de explosiones, excepto cuando el mismo haya sido certificado específicamente para tal uso.

USE ACCESORIOS ADECUADOS Y REALICE CORRECTAMENTE LOS PROCEDIMIENTOS DE AJUSTE

Todos los accesorios de la válvula deben cumplir las especificaciones de la misma y ser compatibles con el uso que se debe dar a la válvula. Arme y ajuste los accesorios de acuerdo con las instrucciones del fabricante.

COMPRUEBE QUE LAS CONEXIONES SEAN A PRUEBA DE FUGAS

Inspeccione cuidadosamente las conexiones de los componentes de vacío para comprobar que hayan sido instalados a prueba de fugas.

HAGA FUNCIONAR LA VÁLVULA CON PRESIONES DE ENTRADA SEGURAS

No haga funcionar nunca la válvula con presiones superiores a la máxima presión nominal (en las especificaciones del instrumento hallará la presión máxima permitida).

INSTALE UNA CÁPSULA DE SEGURIDAD ADECUADA

Cuando el instrumento funcione con una fuente de gas presurizado, instale una cápsula de seguridad adecuada en el sistema de vacío para evitar que se produzcan explosiones cuando suba la presión del sistema.

MANTENGA LA UNIDAD LIBRE DE CONTAMINANTES

No permita el ingreso de contaminantes en la unidad antes o durante su uso. Los productos contaminantes tales como polvo, suciedad, pelusa, lascas de vidrio o virutas de metal pueden dañar irreparablemente la unidad o contaminar el proceso.

MANTÉNGASE ALEJADO DE LA ABERTURA DE LA VÁLVULA

Cuando la válvula esté funcionando, mantenga los dedos, otras partes del cuerpo y otros materiales alejados de la abertura.

Chapter One: General Information

Introduction

The MKS Type T3B Throttle Valve is designed for use in downstream pressure control applications.

The T3B unit consists of a throttle valve with an electronic housing attached to the motor plate, a microprocessor, driver circuits which eliminate the need for a separate controller box, the RS-232 serial communications interface, and analog outputs that reflect pressure or valve position. The valve is controlled by using digital values sent through the serial network.

The operation of the controller is based on a digital pressure/position control algorithm that directs the valve to the proper position for either pressure or position control. The pressure or position setpoint may be sent as a serial command. The T3B unit reads the pressure signal used for control applications directly from an MKS Baratron pressure transducer. All of the unit's operational settings are controlled using the serial communication protocol.

When the T3B controller is turned off or experiences an unexpected power loss, all calibration constants and the last valve position are saved in non-volatile memory. Therefore, when you re-power the unit, it will be calibrated and ready for operation.

Protection from RF interference and noisy electrical environments is increased by the use of a metal case, by internal design elements, and by the use of surge and ESD suppression networks and RFI filtering on all inputs and outputs. The T3B unit meets the testing standards required for the European CE Mark when used with an overall metal braided shielded cable, properly grounded at both ends.

Definitions

Table 5: Definitions

Term	Description
Full Scale (FS) Range	The defined 100% value of an attribute, in its assigned units
sccm	Standard cubic centimeters per minute
Setpoint	The flow value to which the device is controlling the flow of gas
slm	Standard liters per minute
Trip Point	An alarm or warning level

How This Manual is Organized

This manual is designed to provide instructions on how to set up, install, and operate a Type T3B unit.

Before installing your Type T3B unit in a system and/or operating it, carefully read and familiarize yourself with all precautionary notes in the *Safety Messages and Procedures* section at the front of this manual. In addition, observe and obey all WARNING and CAUTION notes provided throughout the manual.

Chapter One, *General Information*, (this chapter) introduces the product and describes the organization of the manual.

Chapter Two, *Installation*, explains the environmental requirements and describes how to mount the instrument in your system. This chapter provides setup and installation procedures.

Chapter Three, *Product Overview*, gives a brief description of the instrument and its functionality.

Chapter Four, *Maintenance and Troubleshooting*, lists any maintenance required to keep the instrument in good working condition, and provides a checklist for reference should the instrument malfunction.

Appendix A, *Product Specifications*, lists the specifications of the instrument.

Appendix B, *Model Code Explanation*, describes the model code used to order the instrument.

Customer Support

Standard maintenance and repair services are available at all of our regional MKS Calibration and Service Centers, listed on the back cover. In addition, MKS accepts the instruments of other manufacturers for recalibration using the Primary and Transfer Standard calibration equipment located at all of our regional service centers.

Should any difficulties arise in the use of your Type T3B instrument, or to obtain information about companion products MKS offers, contact any authorized MKS Calibration and Service Center. If it is necessary to return the instrument to MKS, please obtain an ERA Number (Equipment Return Authorization Number) from the MKS Calibration and Service Center before shipping. The ERA Number expedites handling and ensures proper servicing of your instrument.

Please refer to the inside of the back cover of this manual for a list of MKS Calibration and Service Centers.



Warning

All returns to MKS Instruments must be certified free of harmful, corrosive, radioactive, or toxic materials.

Chapter Two: Installation

Unpacking the Type T3B Unit

MKS has carefully packed the Type T3B unit so that it will reach you in perfect operating order. Upon receiving the unit, however, you should check for defects, cracks, broken connectors, etc., to be certain that damage has not occurred during shipment.



Note

Do *not* discard any packing materials until you have completed your inspection and are sure the unit arrived safely.

If you find any damage, notify your carrier and MKS immediately. If it is necessary to return the unit to MKS, obtain an ERA Number (Equipment Return Authorization Number) from the MKS Service Center before shipping. Please refer to the inside of the back cover of this manual for a list of MKS Calibration and Service Centers.



Caution

Only qualified individuals should perform the installation and any user adjustments. They must comply with all the necessary ESD and handling precautions while installing and adjusting the instrument. Proper handling is essential when working with all highly sensitive precision electronic instruments.

Unpacking Checklist

Standard Equipment:

Type T3B Unit

Type T3B Butterfly Valve With RS-232 Interface Instruction Manual (this book)

MKS Type T3B/T3P Valves with RS-232 Interface Supplement, MKS p/n 134414-P1

You will need the *Supplement* to perform the installation using the procedures provided in this manual.

Interface Cables



Note

An overall metal braided, shielded cable, properly grounded at both ends, is required to meet CE Mark specifications.

Generic Shielded Cable Description

MKS offers a full line of cables for all MKS equipment. Should you choose to manufacture your own cables, follow the guidelines listed below:

1. The cable must have an overall metal *braided* shield, covering all wires. Neither aluminum foil nor spiral shielding will be as effective; using either may nullify regulatory compliance.
2. The connectors must have a metal case with direct contact to the cable shield on the whole circumference of the cable. The inductance of a flying lead or wire from the shield to the connector will seriously degrade the shield's effectiveness. Ground the shield to the connector before its internal wires exit.
3. With very few exceptions, the connector(s) must make good contact to the controller's case (ground). "Good contact" is about 0.01 ohms and the ground should surround all wires. Contact to ground at just one point may not suffice.

4. For shielded cables with flying leads at one or both ends. It is important to ground the shield at each such end *before* the wires exit. Make this ground with absolute minimum length. Refer to Figures 1 and 2. (A ¼-inch piece of #22 wire may be undesirably long since it has approximately 5 nH of inductance, equivalent to 31 ohms at 1000 MHz). After picking up the braid ground, keep wires and braid flat against the case. With very few exceptions, grounded metal covers are not required over terminal strips. If one is required, it will be stated in the Declaration of Conformity.
5. In selecting the appropriate type and wire size for cables, consider:
 - A. Voltage ratings.
 - B. Cumulative I^2R heating of all the conductors (keep them safely cool).
 - C. IR drop of the conductors, so that adequate power or signal voltage gets to the controller.
 - D. Capacitance and inductance of cables that handle fast signals (such as data lines or stepper motor drive cables).
 - E. Some cables may need internal shielding from specific wires to others.

Example 1: Preferred Method to Connect Cable

(shown on a transducer)

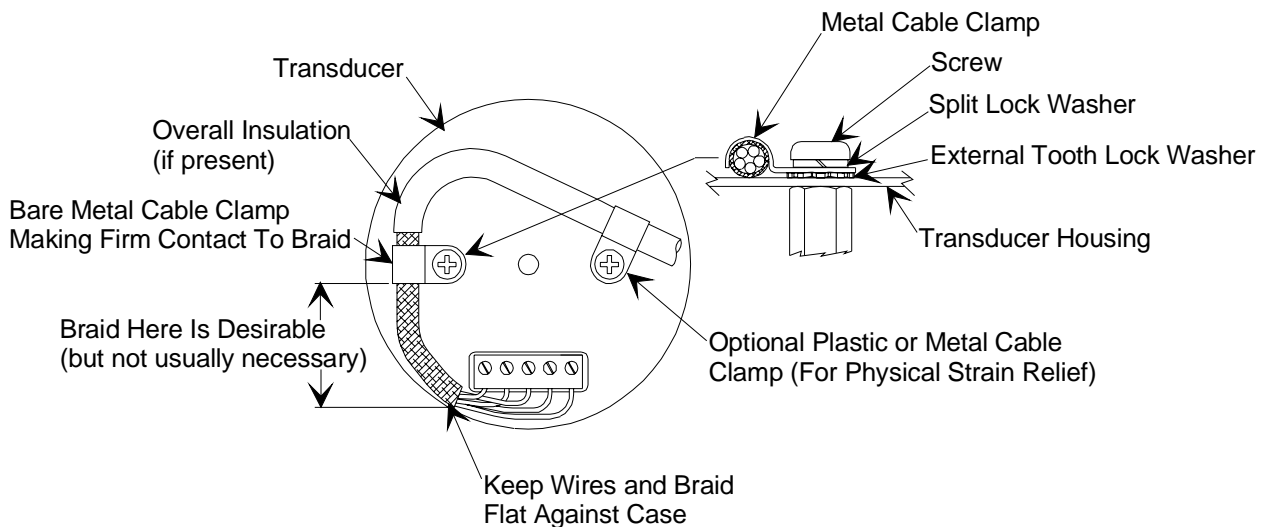

Figure 1: Preferred Method To Connect an Overall Metal Braided Shielded Cable

Example 2: Alternate Method to Connect Cable
(shown on a transducer)

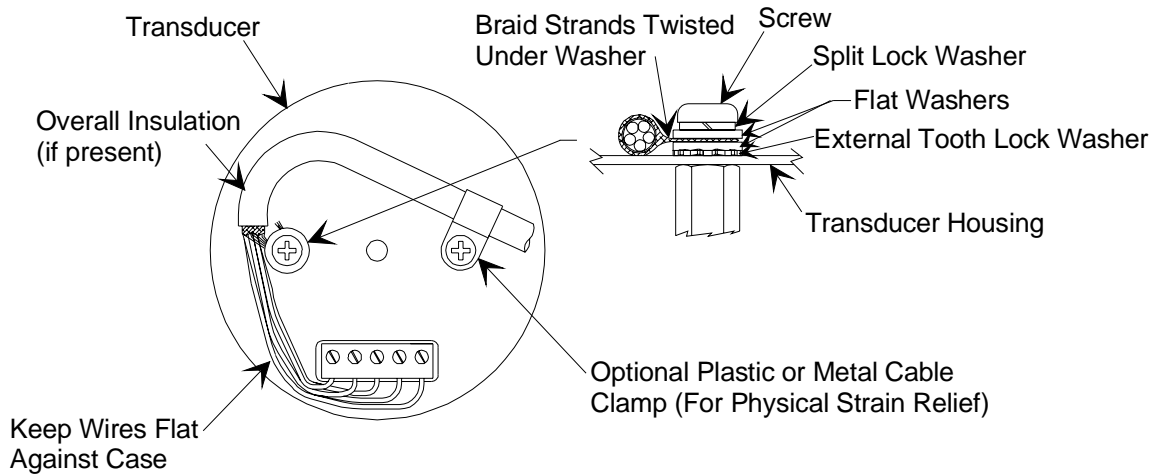

Figure 2: Alternate Method To Connect an Overall Metal Braided Shielded Cable

Use this method when cable clamp is not available.

Product Location and Requirements

Ambient Operating Temperature

The acceptable ambient operating temperature range for the T3B unit is 20° to 40° C.

Power Requirements

T3B Controller

The T3B requires an input voltage of 24.0 VDC @ 3 Amp. If using heated pressure transducers and the power is to be supplied for these from the valve, then their power requirements must be added to the valve power requirements listed above. The T3B can supply up to 750 mA maximum (combined High and Low sensors) for heated pressure transducers. The input voltage is provided by the External Power connector. Refer to Table 9, page 18 for the External Power connector pin out.

Analog Pressure Transducer

An analog pressure transducer requires ± 15 VDC $\pm 5\%$, supplied by an external power source or from the valve. The transducer is connected to the T3B unit using an appropriate interface cable. Contact the MKS Engineering Department for cable information.

When using an analog transducer, the power is received through the T3B External Power connector and is passed on to the transducer through the Sensor connector. Both connectors are located on the top of the T3B unit (refer to Figure 13, page 28). Refer to Table 6, page 16, for the Auxiliary connector pin out, and Table 7, page 17, and Table 8, page 18, for the Analog Sensor connector pin out.

Setup

Mounting Instructions

The T3B unit can be mounted in a vacuum exhaust line with the proper fittings and connectors. For best pressure control, locate the pressure transducer and the exhaust valve as close as practical to the process chamber. This minimizes the time constants associated with these items.



Caution Use tubing that is less than 6 inches long and no less than ¼ inch in diameter to connect the transducer and chamber. If the distance must exceed 6 inches, use a larger diameter tubing to compensate for conductance loss.

System Configuration

A typical system configuration is shown in Figure 3:

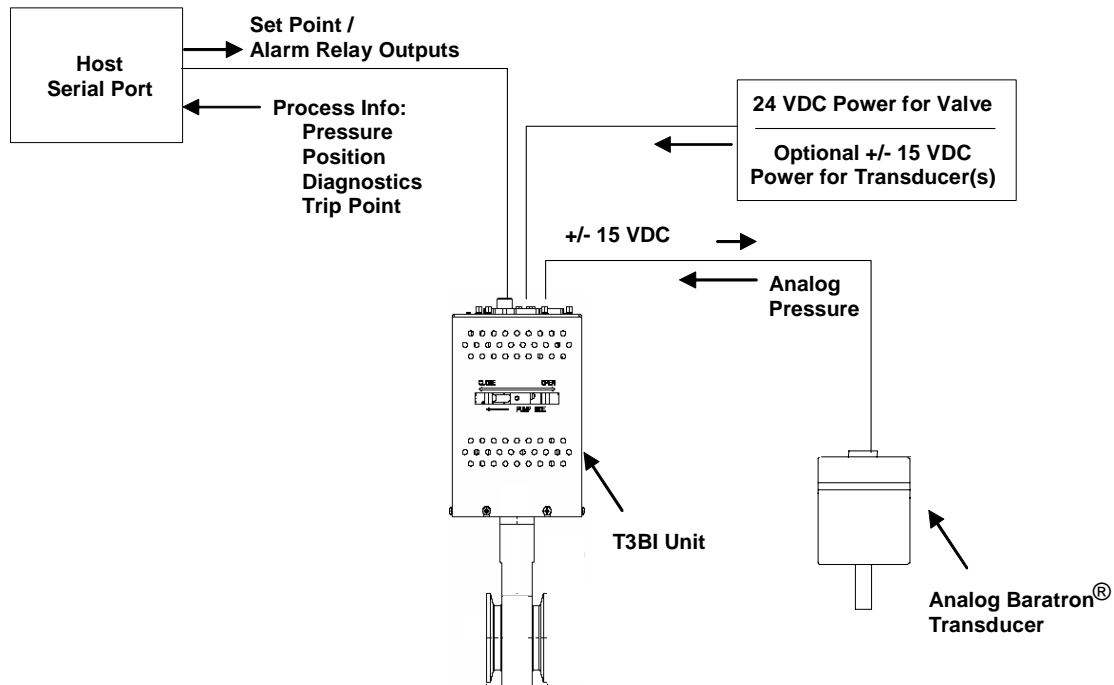

Figure 3: Typical System Configuration

Electrical Information

Connectors

The T3B throttle valve controller has four connectors located on its top panel (refer to Figure 4):

25-pin Female Type “D” Auxiliary Connector

9-pin Male Type “D” External Power Connector

15-pin Female Type “D” Analog (High) Sensor Connector

15-pin Female Type “D” Analog (Low) Sensor Connector



Caution To prevent damage from electrostatic discharge (ESD) to the sensitive connector pins, they must be covered with an ESD protective cover when not in use.

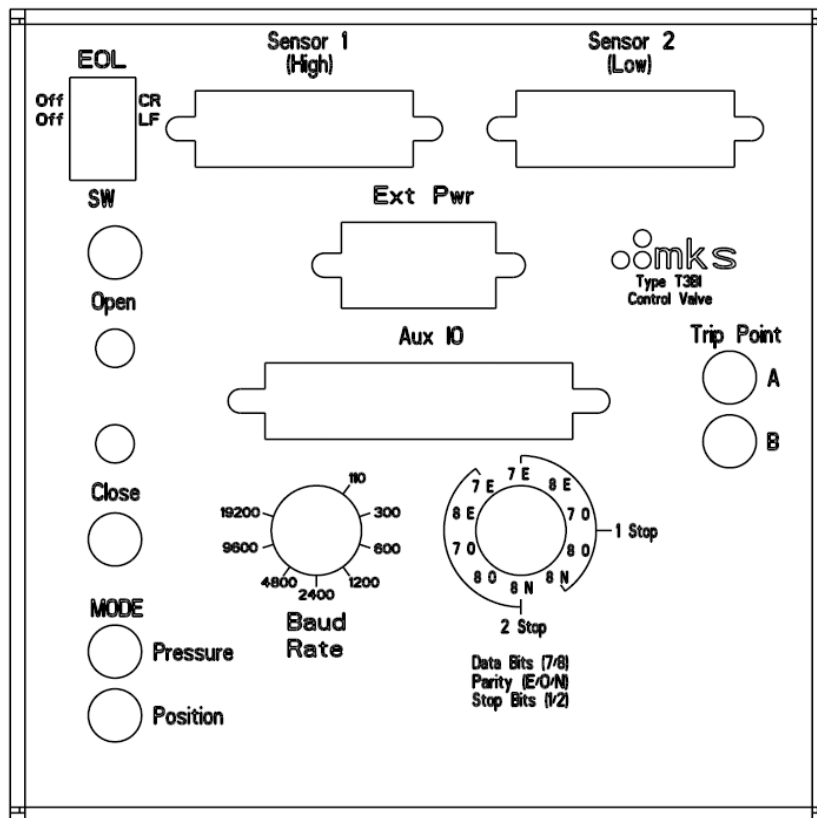

Figure 4: Top Panel of the T3B Unit

Auxiliary Connector

The 25-pin female Type “D” Auxiliary connector provides access to various control and output functions.

Table 6: Auxiliary Connector Pin Out

Pin Number	Description
1	Rx
2	Tx
3	Reserved
4	Reserved
5	Reserved
6	Reserved
7	Reserved
8	Reserved
9	Reserved
10	Reserved
11	Pressure Output (A Out)
12	Position Output (A Out)
13	Analog Ground
14	Relay A – N.O.
15	Relay A – N.C.
16	Relay A – Common
17	Relay B – N.O.
18	Relay B – N.C.
19	Relay B – Common
20	Valve Open Status (D Out)
21	Valve Closed Status (D Out)
22	Interlock (D in)
23	Remote Zero (D in)
24	Digital Ground
25	Chassis Ground

Analog Sensor Connector

The two 15-pin female Type “D” Analog Sensor connectors provide access to the power and pressure input pins for use with analog Baratron sensors.

Table 7: Analog Sensor 1 (High) Connector Pin Out

Pin Number	Description
1	No Connection
2	Pressure Input Signal (+)
3	No Connection
4	No Connection
5	Sensor Power Return
6	-15 V Power Output
7	+15 V Power Output
8	No Connection
9	No Connection
10	No Connection
11	No Connection
12	Pressure Signal Input (-)
13	No Connection
14	+24 Volt Power Output
15	Chassis Ground

Table 8: Analog Sensor 2 (Low) Connector Pin Out

Pin Number	Description
1	No Connection
2	Pressure Input Signal (+)
3	No Connection
4	No Connection
5	Sensor Power Return
6	-15 V Power Output
7	+15 V Power Output
8	No Connection
9	No Connection
10	No Connection
11	No Connection
12	Pressure Signal Input (-)
13	No Connection
14	+24 Volt Power Output
15	Chassis Ground

External Power Connector

The 9-pin male Type “D” External Power connector provides power to the valve.

Table 9: External Power Connector Pin Out

Pin Number	Description
1	+ 24 V Power Input
2	+ 24 V Power Input
3	24 V Return
4	24 V Return
5	+15 V Auxiliary Power Input (for gauges)
6	15 V Return
7	-15 V Auxiliary Power Input (for gauges)
8	(Reserved)
9	Chassis Ground

Startup

Power Up

At power up, your instrument performs checks on its communications link and internal diagnostic checks of the EEPROM and RAM. The results of these checks are indicated by the color (green or red) and condition (solid or flashing) of the status LEDs on top of the unit (refer to Figure 13. page 28). Refer to page 29 for more information on the status LEDs.

When you apply power to your device, the following LED sequence occurs:

1. The Position Status LED flashes one time from GREEN to RED, for approximately 0.25 seconds each, and then turns GREEN.
2. The Pressure Status LED flashes one time from GREEN to RED, for approximately 0.25 seconds each, and then turns OFF.
3. The Position Status LED illuminates solid GREEN when the initialization is complete.

After initialization, the LEDs will change to indicate the current status. This will vary depending on the previous settings.



Note If the power up LED sequence does not function properly, contact MKS for assistance.

Warm Up Time

After installation and power up, your T3B throttle valve controller requires less than 1 minute to warm up.

This page intentionally left blank.

Chapter Three: Product Overview

**Note**

Before continuing with the information in this chapter, be sure to have worked through all descriptions and procedures in Chapter Two.

General Information

The T3B consists of a throttle valve, a microprocessor, an RS-232 serial communications interface, and analog outputs that reflect the pressure or valve position.

Valve Safety

MKS products are designed and tested to provide the highest degree of safety attainable. To use your MKS valve safely, you must always conform to the following instructions:

Refer to Chapter Two for directions on installation and operation of the valve.

**Warning**

The moving parts in the valve create a risk of personal injury until the valve is securely incorporated into a system. To avoid injury keep all objects away from any valve opening.

Do not insert objects into openings where contact with moving parts is possible.

Isolate the equipment from any electrical or pneumatic power supply before handling the valve.

Control Mode

The T3B controls pressure in a vacuum system using either Pressure or Position control.

In *Pressure Control*, the T3B unit moves the valve in order to maintain a desired pressure (the setpoint). The controller uses either a Model Based or a Proportional, Integral, and Derivative (PID) algorithm to determine the valve position and make position adjustments. With Model Based, the control algorithm uses the current pressure, position, and setpoint readings to calculate the next valve position during each control cycle. With PID, the setpoint uses two parameters—the phase and gain—to optimize the response from setpoint to setpoint. Although there are default values for these parameters, you should adjust the values for optimum control (refer to *Tuning the Controller* in the *MKS Type T3B/T3P Valves with RS-232 Interface Supplement*, for more information). The feedback is an analog pressure signal. This signal is normally 0 to 10 Volts, but the zero and full-scale voltages can be adapted to individual applications.

In *Position Control*, the T3B unit moves the valve to a desired position (the setpoint). In this mode, the valve is moved to the desired setpoint but no feedback signal is generated. It is not necessary for the controller to make adjustments once the valve reaches its setpoint.

Model Based Pressure Control

The T3B controls the chamber pressure by utilizing a Model Based Control technique. The valve position is adjusted at each control cycle to regulate the valve conductance and, thus, the chamber pressure itself. An accurate knowledge of the system parameters is required for the optimal operation of the pressure controller. These parameters include the chamber volume and the valve conductance.

LEARN Function

The purpose of the LEARN function is to obtain the chamber pump speed versus valve position using the real operating conditions of sensor type, chamber volume, inlet flow, and pumping system. The LEARN function should be executed prior to normal valve operation. The LEARN function is generally required only once during initial setup/installation. The sequence of steps required to LEARN the valve is as follows:

1. Enter the chamber volume in liters utilizing the valve software interface. An approximate value for volume may be used provided the volume estimator is turned on (see the following step).
2. Determine appropriate setting for the volume estimator:
 - a. If you are confident of the actual chamber volume entered, turn off the volume estimator.
 - b. If you are unsure of the actual chamber volume, turn on the volume estimator. The volume estimator will determine the volume during the system learn and use this volume for pressure control.
3. Set correct pressure transducer ranges. Refer to the *MKS Type T3B/T3P Valves with RS-232 Interface Supplement*, as necessary.
4. Obtain the recommended learn flow setting from the valve software.
5. Turn on flow to the desired rate for the duration of the LEARN test.
6. Enter the actual flow rate that is being used.
7. Start the LEARN function.

The flow rate should remain constant until the LEARN function is completed. The LEARN function moves the valve over a set of non-uniformly distributed positions and records the pressure data from the valve high channel transducer. The typical duration of the LEARN function execution is less than 45 seconds. The pressure data versus time resembles Figure 5. If the actual flow is significantly lower than the recommended flow (dotted line), the accuracy of the obtained chamber pump speed may be insufficient. If the actual flow is much higher than the recommended flow (dashed line), the pressure transducer saturation may occur. This will result in incorrect pump speed curve and will negatively affect the quality of pressure control.

Adjust the flow, if necessary, and rerun the system learn starting with Step 5 above.

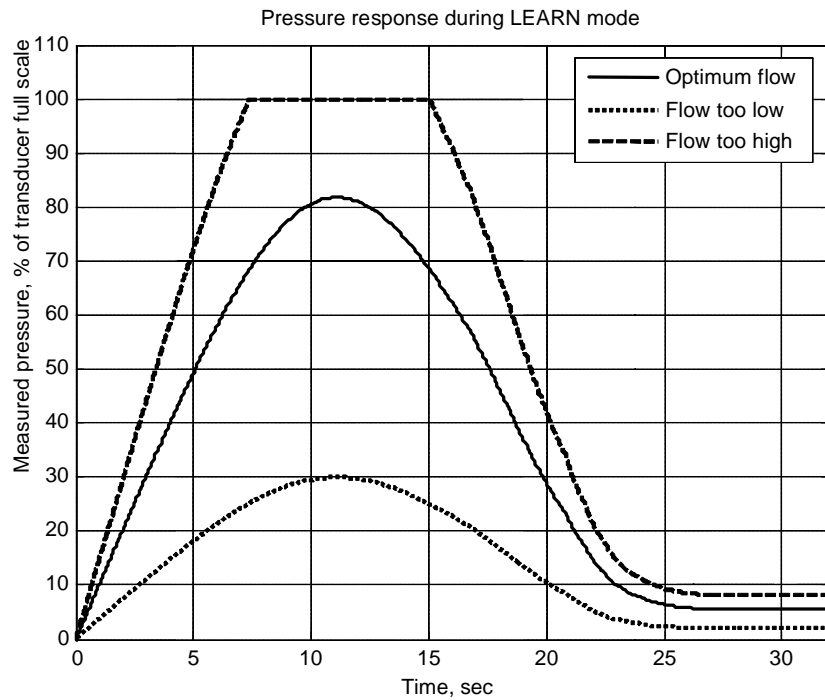

Figure 5: Typical Pressure Response in LEARN Mode

The typical chamber pump speed versus valve position is shown in Figure 6.

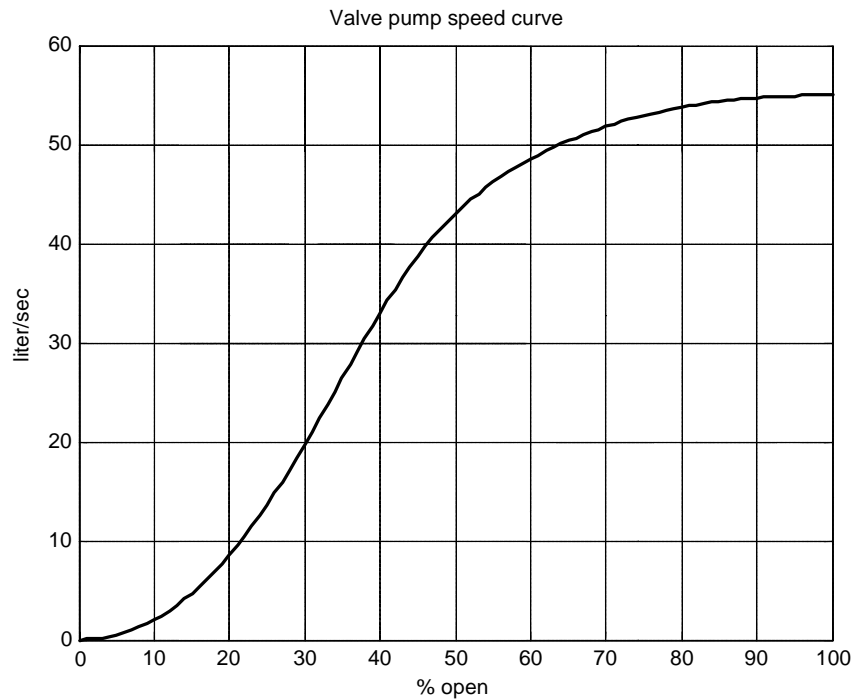

Figure 6. Typical Chamber Pump Speed Curve

Refer to the *MKS Type T3B/T3P Valves with RS-232 Interface Supplement* for more information on how to learn the system.

Phase and Gain

The T3B unit uses a PID compensator to control pressure in a vacuum system. When a new pressure setpoint is commanded, the unit responds by changing the pressure smoothly to the desired value. If the pressure is slow to change or oscillates, the PID compensator must be re-tuned. The phase and gain values can be manually adjusted to provide the best response to the setpoint. By careful adjustment of each value, it is possible to achieve optimum control throughout a wide range of pressure regions.

Phase

The phase provides a control signal that is proportional to the change in the error signal. The error signal is the difference between the actual pressure and the setpoint. The phase is responsible for controlling how quickly the pressure responds to a change in setpoint. A large phase generally results in a faster response to setpoint. However, if the phase is too large, the system will be slow in responding to setpoint and, in some cases, may oscillate around the setpoint (refer to Figure 7). If the phase is too small, the pressure will overshoot and then oscillate around the setpoint before settling in (refer to Figure 8).

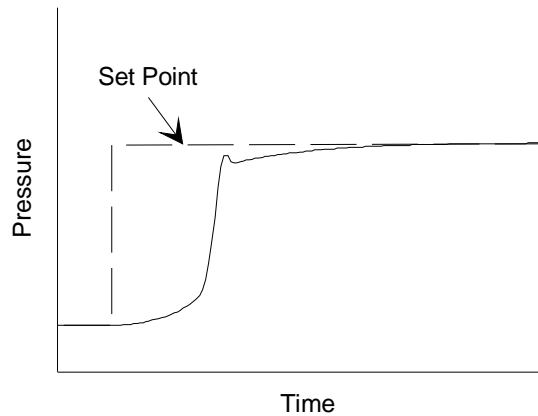

Figure 7: Phase Set Too High

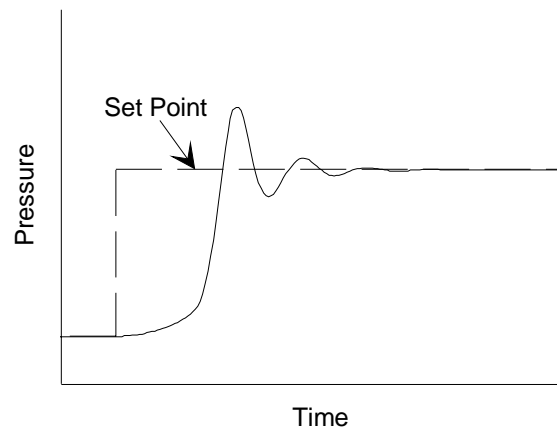

Figure 8: Phase Set Too Low

Gain

The gain provides a control signal that is proportional to the error signal. The gain allows the controller to track the setpoint with minimal steady state error. The highest possible gain setting produces the best pressure control. A high gain setting generally results in a faster response to setpoint, and the best rejection of disturbances such as changes in flow rate or noise in the system. However, if the gain is too large, the pressure will overshoot the setpoint before settling in (refer to Figure 9). If the gain is too small, the pressure will respond slowly to a setpoint change (refer to Figure 10) or a change in flow rate.

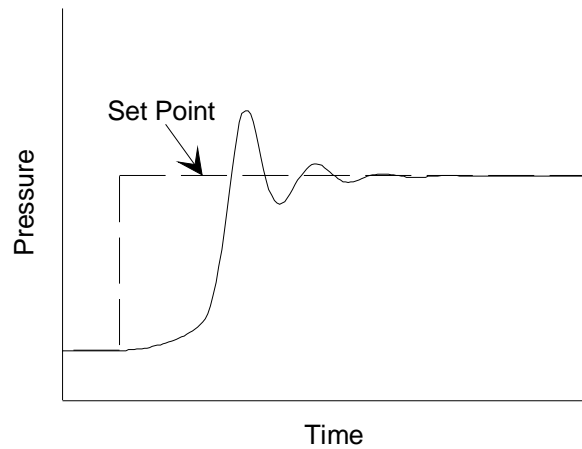

Figure 9: Gain Set Too High

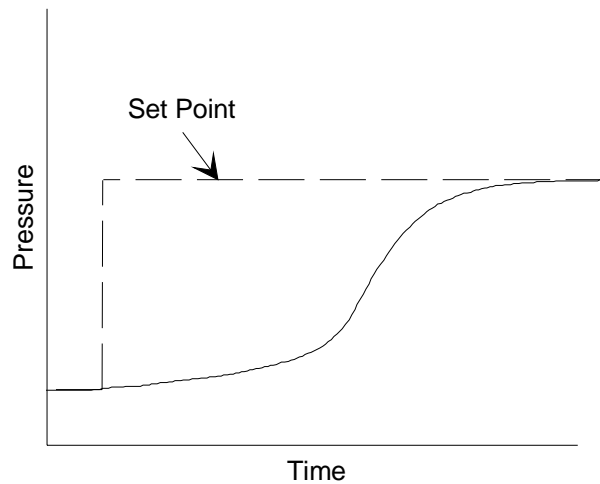

Figure 10: Gain Set Too Low

Trip Points

The T3B has four software trip points. The trip points are adjustable using digital communication commands, such that when the pressure rises above or below the specified trip point value, the corresponding trip point changes state.

The four trip points can be configured to monitor either the pressure value or the valve position; any combination is acceptable. In addition, two of the trip points can be mapped to hardware relays through the Auxiliary connector. Refer to Table 6, page 16, for the Auxiliary connector pin out.

Trip Point Hysteresis

Hysteresis is built into the operation of the trip points to help compensate for the noise inherent in all systems. Without hysteresis, the noise may cause the trip points to repeatedly switch states, a condition known as “relay chatter.” Hysteresis is set as a percentage of the current trip point value. The default hysteresis value of 10% can be adjusted with a digital command (refer to *Trip Point Hysteresis* in the *MKS Type T3B/T3PValves with RS-232 Interface Supplement* for more information).

Setting the hysteresis too high creates a *deadband* around the trip point. The deadband prevents the trip point from responding to changes in the pressure signal around the trip point. Ideally, the hysteresis should be close to, but not less than, the peak-to-peak noise. This setting will provide maximum immunity from relay chatter while providing the best possible accuracy. It may take some trial and error efforts to determine the smallest hysteresis setting appropriate for your system.

Trip Point Delay

The trip point delay defines the amount of time a trip point alarm condition must exist before the trip point status attribute reports an ON condition. If the trip point condition exists for a time period that is less than the specified trip point delay, the trip point status attribute remains OFF. The trip point delay is illustrated in Figures 11 and 12, page 27.

The trip point delay can be set from 0 to 10,000 msec; the default value is 0. Different trip point delay values can be set for the trip point(s) (refer to *Trip Point Alarm Delay* in the *MKS Type T3B/T3PValves with RS-232 Interface Supplement*).

Trip Point Direction

The trip point polarity, or direction, defines the direction of pressure change that will energize the trip point. The direction of the trip points can be adjusted with a digital command, as described in *Trip Point Direction* in the *MKS Type T3B/T3P Valves with RS-232 Interface Supplement*.

The initial direction for all of the trip points is “low.” The trip point is energized and the trip point LED illuminates as the pressure falls *below* the specified trip point value. The trip point is not de-energized and the LED is not cleared until the pressure rises above the value defined by the corresponding trip point hysteresis, as shown in Figure 11.

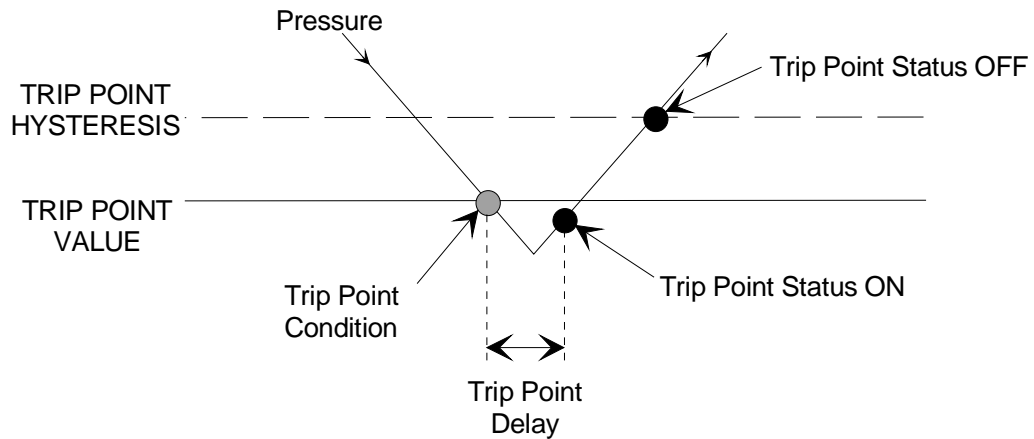

Figure 11: Trip Point Direction Set Low

The direction for any of the trip points can be changed to “high.” The trip point is energized and the trip point LED illuminates as the pressure rises *above* the specified trip point value. The trip point is not de-energized and the LED is not cleared until the pressure falls below the value defined by the corresponding trip point hysteresis, as shown in Figure 12.

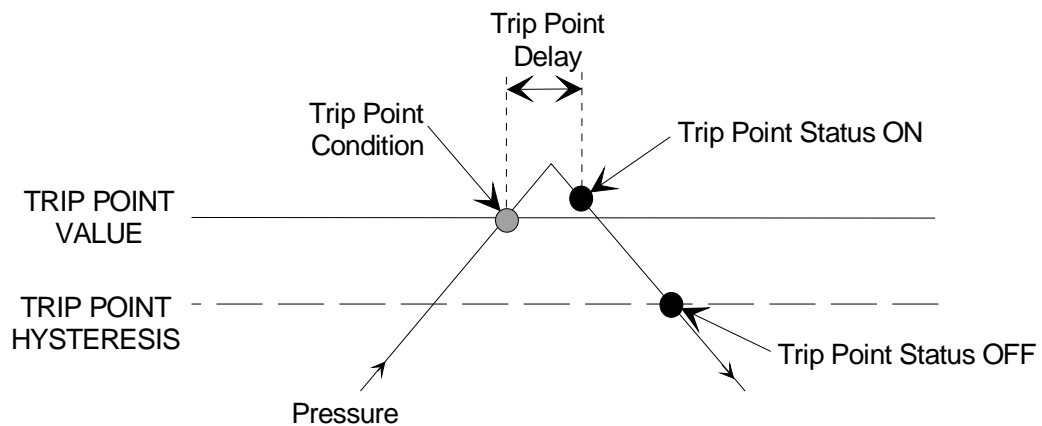

Figure 12: Trip Point Direction Set High

Top Panel Components

The top panel of the T3B is shown in Figure 13.

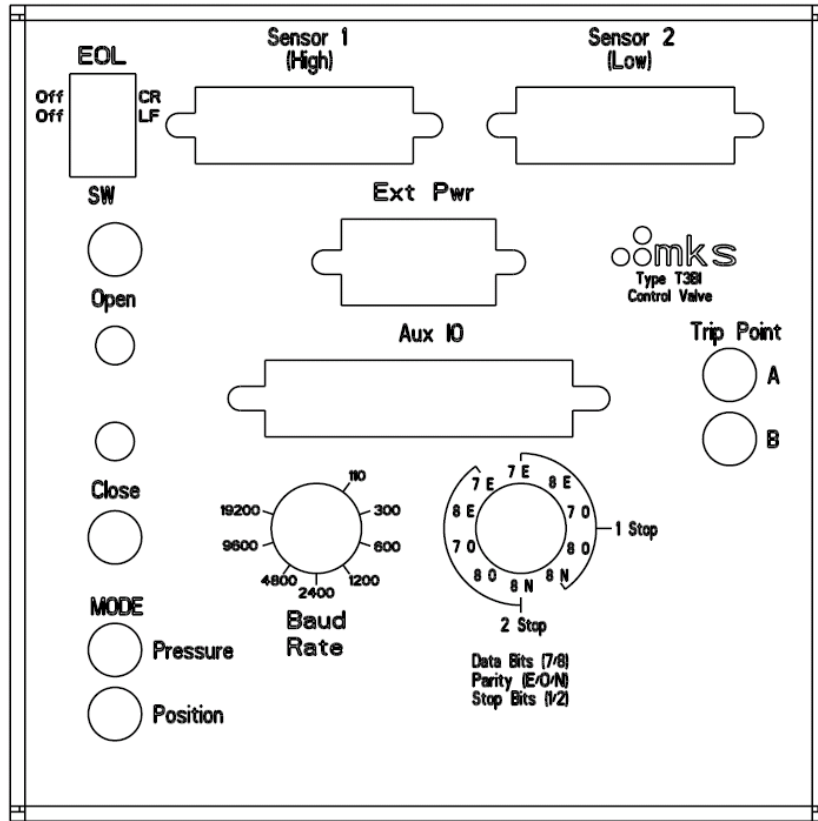

Figure 13: Top Panel of the T3B Unit

Analog Sensor Connectors

The two 15-pin female Type “D” Analog Sensor connectors provide access to the power and pressure input pins for use with analog Baratron sensors. Refer to Table 7, page 17, and Table 8, page 18, for the Analog Sensor connector pin out.

Auxiliary Connector

The 25-pin female Type “D” Auxiliary connector provides access to the alarm relay outputs for use with an analog sensor and provides an interface for the RS-232 serial communication. Refer to Table 6, page 16, for the Auxiliary connector pin out.

Power Connector

The 9-pin male Type “D” power connector provides power entry to the valve. Refer to Table 9, page 18, for connector pin out. The +24V power is to operate the valve and the +/-15V is an option to power the analog sensors directly.

Valve Position Indicator LEDs

The OPEN indicator light, located to the left of the manual valve switch, illuminates red when the valve is fully open. The CLOSE indicator light is located to the right of the manual switch and illuminates red when the valve is in the fully closed position.

Manual Valve Switches

These push button style switches allow you to manually drive the valve to the open or closed position.

Trip Point Indicator LEDs

These LEDs illuminate green when a trip point is energized.

Position Status LED

The Position Status LED illuminates a solid green when the device is in Position Control Mode. If interlock is not enabled, the Position Status LED illuminates a flashing red. The Position Status LED illuminates an alternating red/green when the device is learning valve steps.

Table 10: Position Status LED Indicators

LED State	Meaning
Solid Green	Position Control Mode
Flashing Green	—
Solid Red	Unrecoverable fault
Flashing Red	Interlock not enabled
Off	No power, if Pressure Status LED also off
Red/Green	Learning valve steps

Pressure Status LED

The Pressure Status LED illuminates a solid green when the device is in Pressure Control Mode (Model Based). The LED flashes green when the device is in Pressure Control Mode (PID). If a fault condition is detected, the Pressure Status LED illuminates a solid red. If there is no power, the Pressure Status LED (and Position Status LED) is off. The Pressure Status LED illuminates an alternating red/green when the device is learning conductance.

Table 11: Pressure Status LED Indicators

LED State	Meaning
Solid Green	Pressure Control Mode (Model Based)
Flashing Green	Pressure Control Mode (PID)
Solid Red	Unrecoverable fault
Flashing Red	—
OFF	No power, if Position Status LED also off
Red/Green	Learning conductance

Baud Rate Switch

The baud rate for your device can be set manually using the rotary switch located on the top panel of the device (refer to Figure 13, page 28).

The switch positions are numbered in a clockwise direction to correspond to the increasing baud rate values.

Data Bits, Parity, and Stop Bits

The data bits, parity, and stop bits for your device are set manually using the rotary switch located on the top panel of the device (refer to Figure 13, page 28).

Labels

There are two labels on the T3B.

Pump Label

The pump label, shown in Figure 14, indicates which side of the valve should be oriented toward the high vacuum pump during installation.

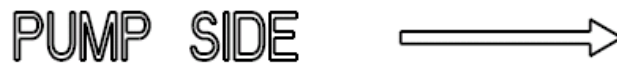

Figure 14: Pump Label

Serial Number Label

The serial number label lists the serial number, product model code, full-scale range, and calibration gas for your device. The label also displays the CE mark signifying compliance with the European CE regulations.



Figure 15: Serial Number Label

The options for your controller are identified in the model code when you order the unit. Refer to Appendix B, *Model Code Explanation*, for more information.

Chapter Four: Maintenance and Troubleshooting

General Information

In general, the T3B requires no maintenance other than proper installation and operation. If the controller fails to operate properly upon receipt, check for shipping damage and check the cables for correct continuity. Any damage should be reported to the carrier and MKS Instruments immediately.

If it is necessary to return the unit to MKS for service, obtain an ERA Number (Equipment Return Authorization Number) from any MKS Calibration and Service center before shipping. Please refer to the inside back cover of this manual for a list of MKS Calibration and Service Centers.



Warning

All returns to MKS Instruments must be free of harmful, corrosive, radioactive, or toxic materials.

Maintenance

Periodically check for wear on the cables and inspect the enclosure for visible signs of damage.

Cleaning the Unit

Periodically wipe down the unit with a damp cloth.

Troubleshooting

The following sections contain basic information for identifying and solving problems with your device. MKS also offers standard maintenance and repair services, including recalibration at the MKS Regional Calibration and Service Centers.

General

Symptom	Root Cause	Correction
At closed position, closed conductance fails spec.	The seal on the flapper damaged or worn (if so equipped).	Consult the factory for a seal replacement kit.
Valve does not open.	Missing interlock on 25 pin DI/DO connector, pins 22 to 24.	Connect pin 22 to 24, or verify external interlock wiring.
	No 24V power is present at the valve terminals.	Verify 24V power is applied to the valve.
	Defective valve.	Return to MKS repair facility.
Valve does not close.	Missing interlock on 25 pin DI/DO connector, pins 22 to 24.	Connect pin 22 to 24, or verify external interlock wiring.
	No 24V power is present at the valve terminals.	Verify 24V power is applied to the valve.
	Defective valve.	Return to MKS repair facility.

Symptom	Root Cause	Correction
Valve fails to control pressure. Pressure reported by valve is FS.	Sensor disconnected.	Reconnect sensor.
Valve fails to control pressure. Pressure reported by valve is low or zero.	Manometer not powered.	Verify power to manometer.
Poor pressure control—oscillating.	Tuning parameters are improper.	If using PID Mode, optimize Gain and Phase values (see <i>Phase and Gain</i> , page 24). If using Model Based mode, re-learn the Pump Speed Curve (see <i>LEARN Function</i> , page 22).
Desired pressure can no longer be achieved.	The seal on the flapper is worn or damaged (if so equipped).	Consult the factory for a seal replacement kit.
Poor pressure control. Indicated pressure is too high or low (Control offset).	Ground connections have too high impedance.	Using MKS valve GUI, determine if control offset is tuning or system ground offset.
	Tuning parameters are improper.	Tuning parameters need optimization.
Poor pressure control in a specific pressure range.	Crossover point not correct.	Configure crossover pressure for installed manometers.
Valve reports negative pressure.	Manometer not zeroed.	Zero manometer.
	Manometer does not have power.	Verify power to manometer.
Valve reports unexpected pressure.	Manometer Full Scale setup not correct.	Configure valve for correct manometer range (see the <i>MKS Type T3B/T3P Valves with RS-232 Interface Supplement</i>).
	Voltage range for manometer not correct.	
Pump Speed Learn does not work	Manometer needs to be plugged in high range for Pump Speed Learn to be performed.	Plug manometer in high range.

Communications

Symptom	Root Cause	Correction
RS-232 communications fail.	Incorrect settings or bad cable.	Verify baud rate, data bits, parity, and CR-LF. Verify cable wiring.
DeviceNet communications fail.	Incorrect settings or lack of network power.	Verify MAC address and baud rate. Verify network power.

Appendix A: Product Specifications

Digital Communication Specifications

Connector	25-pin, Female Type “D”
Data Bits, Parity, Stop Bits Switch	7 or 8 Data bits, even, odd, none parity, 1 or 2 stop bits
Maximum Cable Length	50 ft.
Response Time	< 20 msec (typical)

Electrical Specifications

CE Compliance Electromagnetic Compatibility ¹ Product Safety Requirements Machinery Directive Low-Voltage Requirements Installation Category Pollution Degree	Meets Directive 2004/108/EEC Meets Directive 92/59/EEC Meets Directive 89/392/EEC Meets Directive 73/23/EEC II, according to EN 61010-1 2, according to IEC 664
Connectors Auxiliary External Power Analog Sensors	25-Pin Female Type “D” 9-Pin Male Type “D” 15-Pin Female Type “D”
Power Requirements	24.0 VDC @ 3 Amp (2 Amps for the motor drive and up to 750 mAmps for the pressure sensor gauges)
Signal Inputs Pressure	0 to +10 VDC Typical (software configurable for other ranges)
Signal Output Analog TTL Open Collectors	Pressure out, position out None Alarms; 2, rated for 30 VDC @ 250 mA maximum (levels and assignment to position, pressure, setpoint via software)

Environmental Specifications

Ambient Operating Temperature Range	20° to 40° C
Operating Humidity Range	0 to 95% RH, non-condensing
Storage Temperature Range	-20° to 80° C

¹ An overall metal braided shielded cable, properly grounded at both ends, is required during use.

Performance Specifications

Control Range	
Pressure Control	0.5 to 100% of sensor range
Position Control	0° to 90°
Controller Repeatability	±0.1% of FS

Due to continuing research and development activities, these product specifications are subject to change without notice.

Appendix B: Model Code Explanation

Model Code

The options for your T3B are identified in the model code when you order the unit. The model code is identified as follows. T3BIB is the RoHS version.

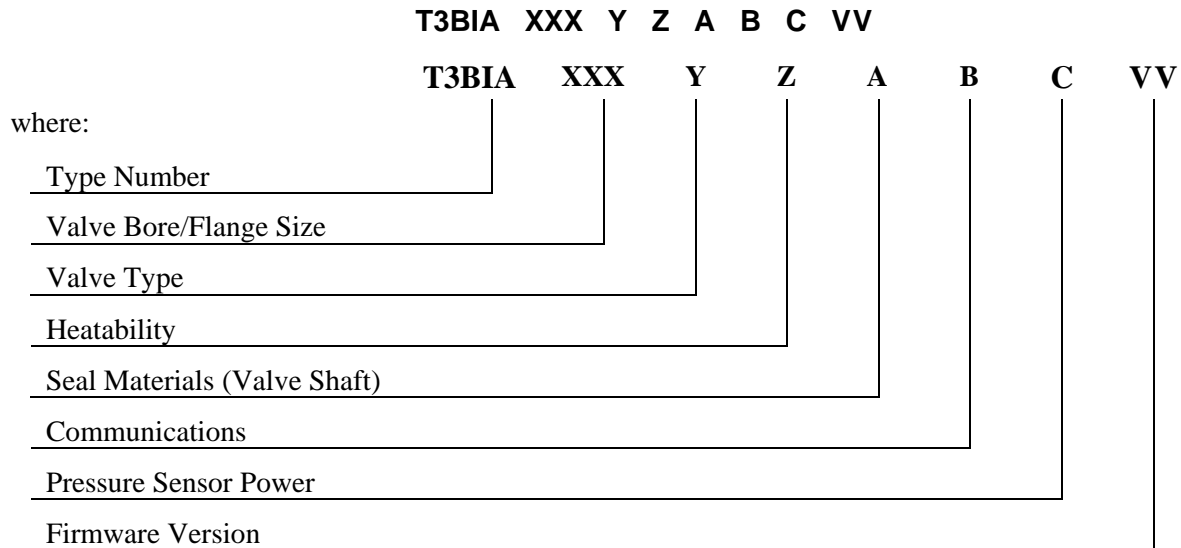

Type Number (T3BIA)

This designates the model number of the instrument.

Valve Bore/Flange Size (XXX)

The valve bore (the internal valve diameter) in millimeters (mm) and the type of flange is indicated by a three-character code.

Valve Bore	Flange	Ordering Code
20 mm	KF-25	19K
20 mm	KF-40	20K
1 in	KF-40	01K
2 in	KF-50	02K
60 mm	NW-63	60N
3 in	NW-80	03N
4 in	NW-100	04N

Valve Type (Y)

The type of valve is indicated by a single number code.

Valve Seal	Ordering Code
Non-Sealing, Direct Drive	2
Low Conductance F-Seal, Direct Drive	3

Heatability (Z)

The heatability is indicated by a single number code.

Interface	Ordering Code
Up to 105° C (standard)	1
Up to 150° C (optional)	2

Seal Materials (Valve Shaft) (A)

Seal materials are indicated by a single letter code.

Motor Drive	Ordering Code
Viton	V
Chemraz E38	C
Chemraz 592	D
Kalrez 8085	K
Kalrez 4079	L

Communications (B)

The options for the T3B unit are indicated by a single number code.

Options	Ordering Code
DeviceNet	9
RS-232	2
Analog/TTL	0

Pressure Sensor Power (C)

The options for the T3B unit are indicated by a single number code.

Options	Ordering Code
None	1
±15 VDC @ 650 mA total	2

Firmware Revision (VV)

The revision of firmware installed in your unit is indicated by a two-character code. Unless otherwise specified, MKS will ship the current firmware revision.

Appendix C: Dimensions



Note

All dimensions are listed in inches with millimeters referenced in parentheses. All dimensions are for reference only.

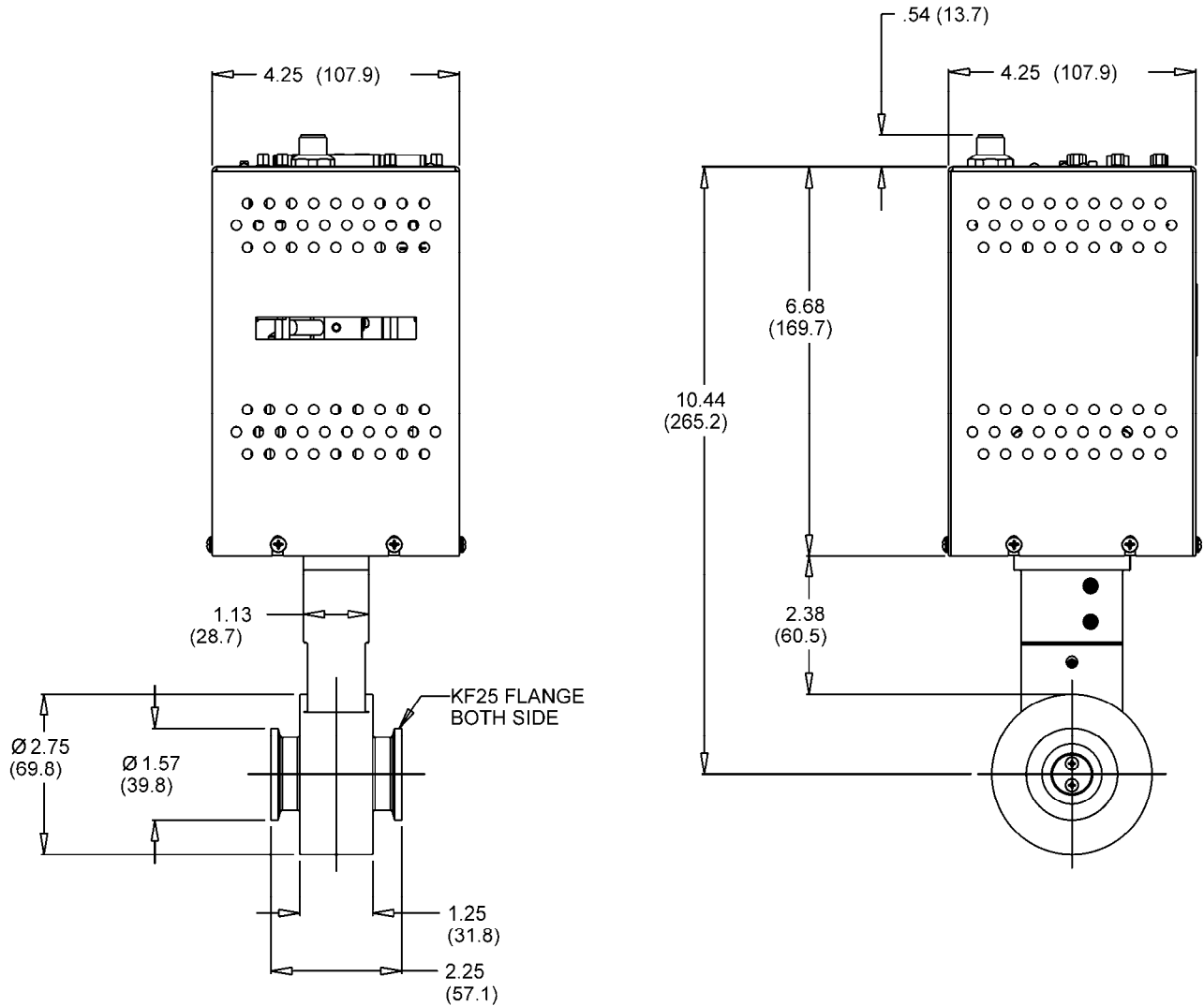

NOTE:

DIMENSIONS SHOWN ARE FOR REFERENCE ONLY.

**Outline Drawing
T3B KF-25 Flange**

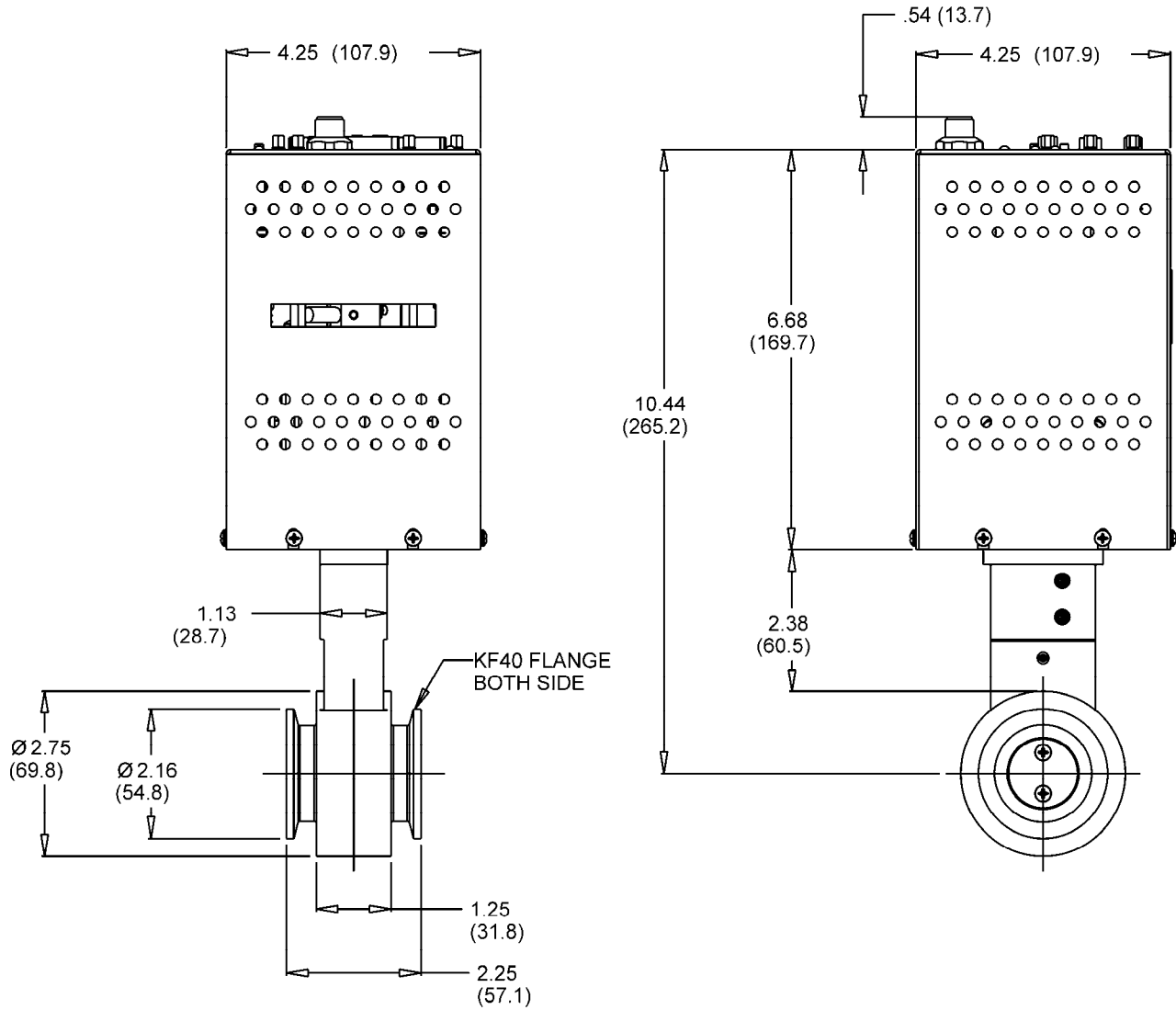

NOTE:

DIMENSIONS SHOWN ARE FOR REFERENCE ONLY.

**Outline Drawing
T3B KF-40 Flange**

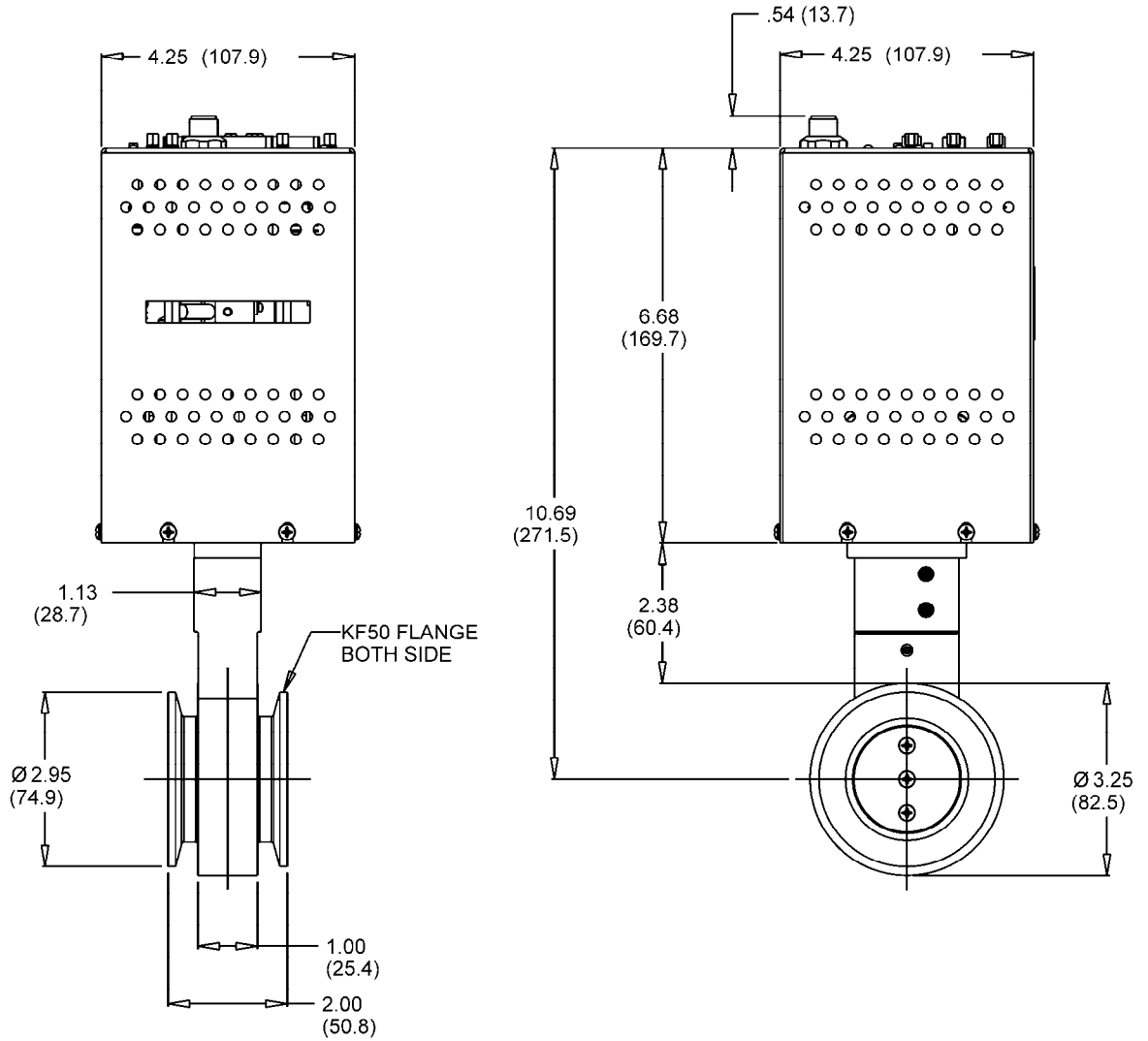

NOTE:

DIMENSIONS SHOWN ARE FOR REFERENCE ONLY.

**Outline Drawing
T3B KF-50 Flange**

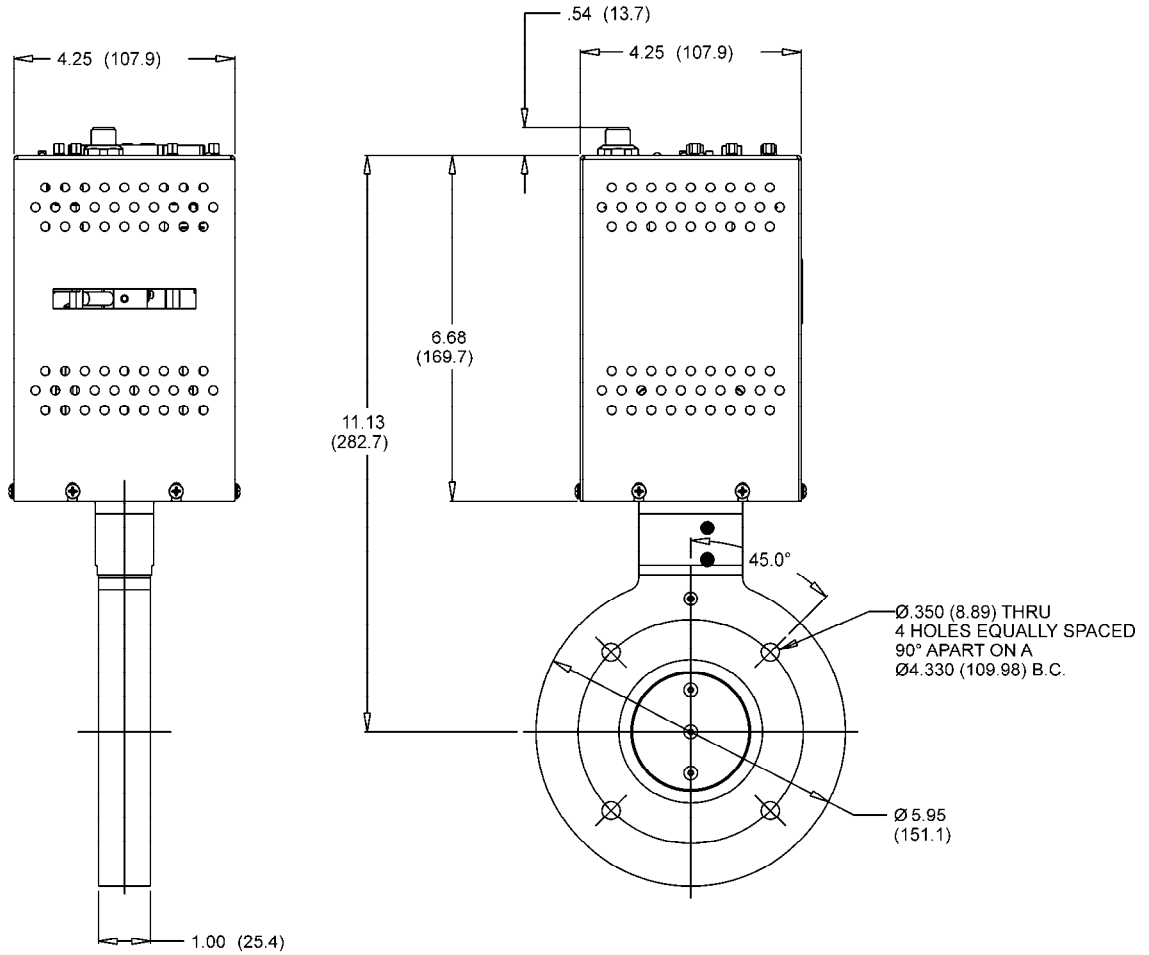

NOTE:
 DIMENSIONS SHOWN ARE FOR REFERENCE ONLY.

**Outline Drawing
 T3B NW-63 Flange**

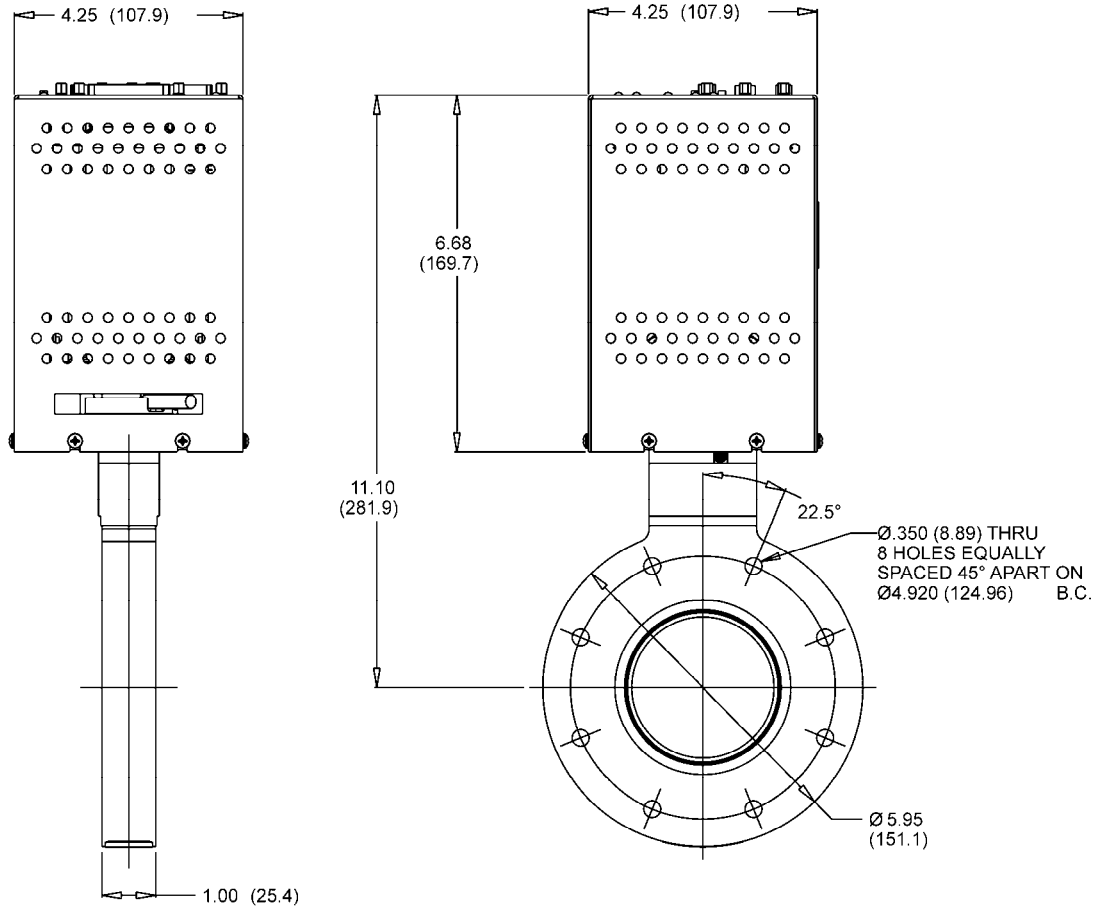

NOTE:
DIMENSIONS SHOWN ARE FOR REFERENCE ONLY.

**Outline Drawing
T3B NW-80 Flange**

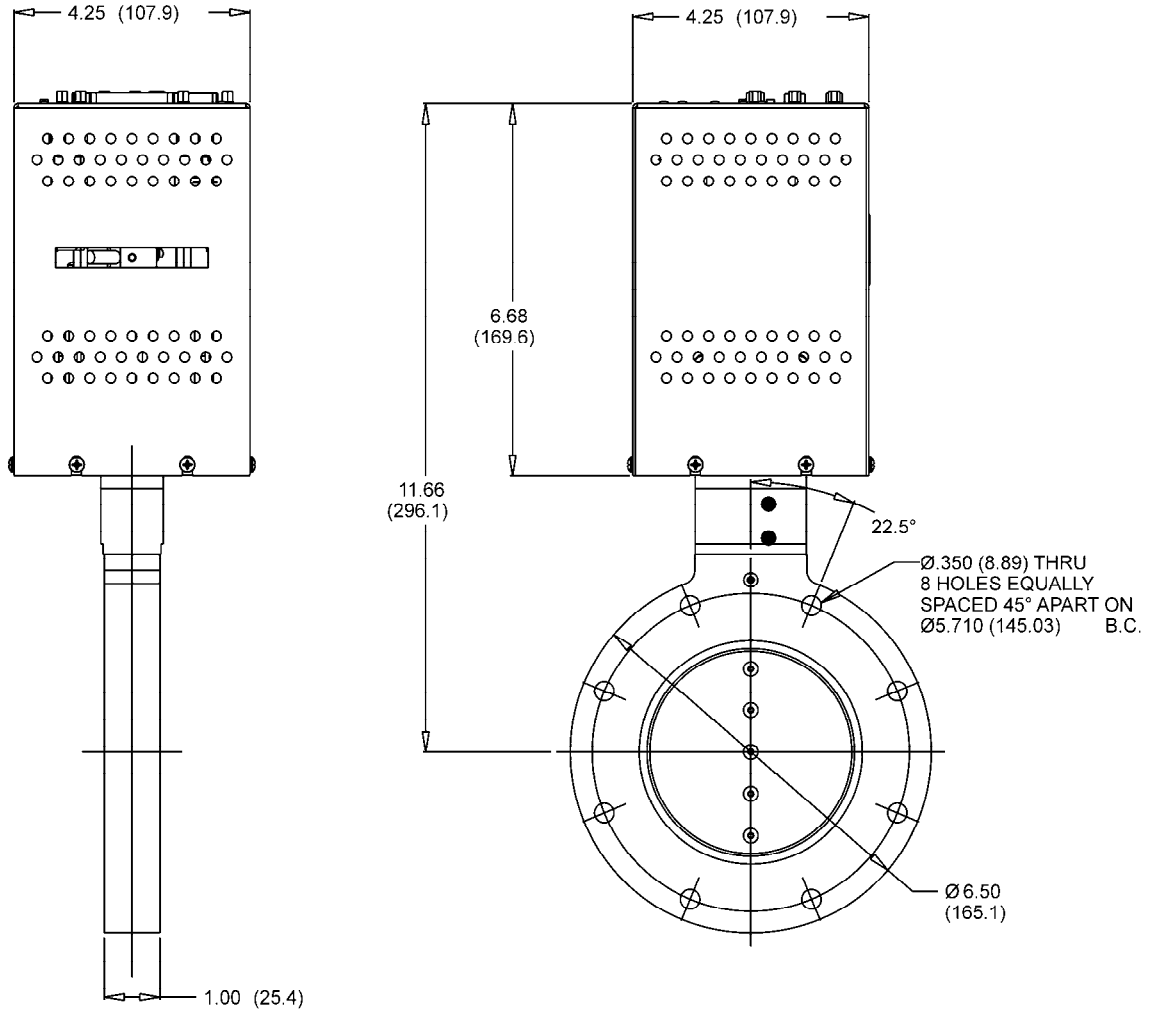

NOTE:
DIMENSIONS SHOWN ARE FOR REFERENCE ONLY.

**Outline Drawing
T3B NW-100 Flange**

Index

- Ambient operating temperature, 13
- Analog pressure transducer, 13
- Analog set point, 21
- CE Mark, 33
- Connectors
 - Analog Sensor, 17, 18, 28
 - Auxiliary, 16, 28
- Control mode, description of, 21
- Firmware revision
 - ordering code, 36
- Gain, 25
- Hysteresis, description of, 26
- Introduction, 9
- Labels
 - pump, 30
 - serial number, 30
- LEDs
 - module status, 29
 - network status, 29
 - power up sequence, 19
- Maintenance, 31
- Model code, 35
- Module status LED, 29
- Mounting instructions, 14
- Network status LED, 29
- Phase, 24
- Position control, 9
 - description of, 21
- Power up, 19
- Pressure control, 9
 - description of, 21
- Pump label, 30
- Serial number
 - label, 30
- Specifications, 33–34
- Temperature
 - operating, 13
 - storage, 33
- Trip point
 - delay, 26
 - direction, 26, 27
 - hysteresis, 26
- Valve
 - safety, 21
- Warm up time, 19

