

Integrated

Series 31

ISO-KF FITTINGS
SIZES NW 10 TO NW 100
(1/2" TO 4")

Process Solutions

WWW.MKSINST.COM



Series 31 is a line of ISO-KF standard vacuum components. The ISO-KF system refers to the family of small vacuum components (up to 2"), including flanges, elbows, tees and crosses. The International Standards Organization (ISO) has defined the interface dimensions, allowing the interchanging of components that conform to the standard's dimensions.

Applications

ISO-KF fittings can be used in a wide variety of applications including:

- Roughing and foreline plumbing
- Small systems
- Systems requiring frequent cleaning or modification
- Research and teaching laboratories

ISO-KF components are primarily designed for use at subatmospheric pressure. Because of the large number of elastomer seals used, typical limiting pressure without baking is about 10^{-7} Torr. Baked systems using Viton® seals can be used to two decades lower.

Standard components can be used to slight overpressure. If the ISO-KF system contains significant overpressure, i.e., 5-100 psig, then use the MKS overpressure rings.

Description

The ISO-KF system is a modular, building block method of creating a piping system. There are several advantages in the use of ISO components. Since component dimensions are standardized, elbows, tees, crosses or valves for a given size may be interchanged.

The flanges are "sexless" and the seal is symmetrical, so that the components are rotatable. By using ISO components, system assembly is quick and cost effective. See Figure 1 for the ISO dimensions of flange sizes 10, 16, 25, 40 and 50. These dimensions apply to ISO-KF flanges of these nominal diameters throughout this catalog. The catalog contains dimension specifics.

The Series 31 component line also includes a few components in NW 80 (3") and NW 100 (4") sizes. There is no international standard for these sizes in the KF style. MKS has designed the flanging using series consistencies and customer requirements.

Installation

The ISO-KF components are assembled by inserting a centering ring between the two flange faces, then securing the assembly with a flange encompassing clamp (see Figure 2).

There are a variety of clamp choices in the Series 31 line. The wing-nut clamp, shown in Figure 2, is hand tightened until metal contact is felt. A version of the wing-nut clamp with a washer is available, contact MKS for more information.

The MKS toggle clamp is convenient and easy to use. The clamp provides enough sealing force to fully compress the O-Ring, so that the flanges and the centering ring are metal to metal. The heavy-duty spring supports the full range of production tolerance variables.

The self-adjusting clamp locks in a positive method. A pin can be inserted to prevent accidental release of the

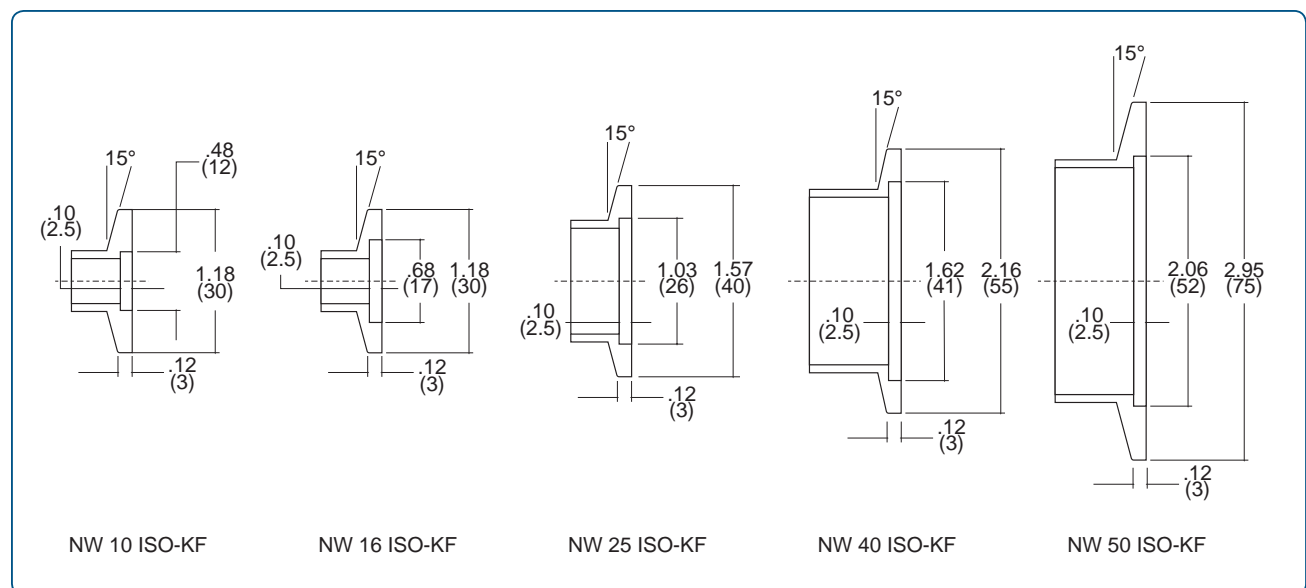

Figure 1 —
ISO-KF Flange Dimensions



Ordering Information

toggle lever (see Figure 3). The toggle clamps are ideal for situations where the clamp must be removed frequently, like leak testing or gauge calibration.

An additional option to the toggle clamp is a model with a fastening pin on a lanyard. The pin is fastened so that it cannot be accidentally removed and the lanyard prevents the pin's loss.

The Series 31 ISO-KF line also includes bulkhead clamps. They are used to attach an ISO-KF flange directly to a chamber or base plate. The two-part, bolted clamp fits over the flange. A centering ring assembly is needed between the flange and the opening. The bulkhead clamp kit includes the two-piece clamp, bolts and washers (see Figure 4).

The NW 10 flange uses the same basic flange and clamp as the NW 16 flange, and the two flanges can join via an adaptive centering ring (see Figure 5). Adaptive centering rings are also available for obsolete sizes (NW 20, NW 32) in the ISO-KF series.

Weld assembly of stainless or aluminum parts should be performed by an experienced TIG welder. Using a rotating fixture simplifies creation of high quality joints. MKS aluminum weld stubs are chamfered for using filler metal. Improper welding can lead to warping of flanges.

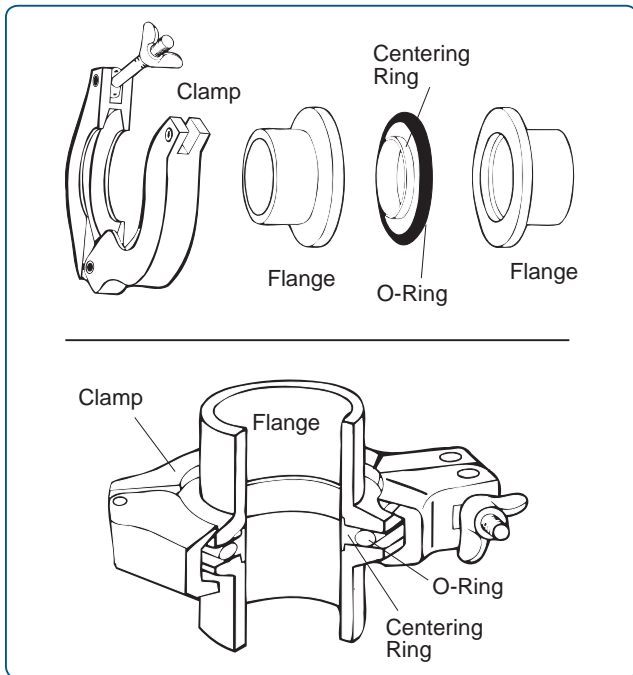

Figure 2 —
Component Assembly

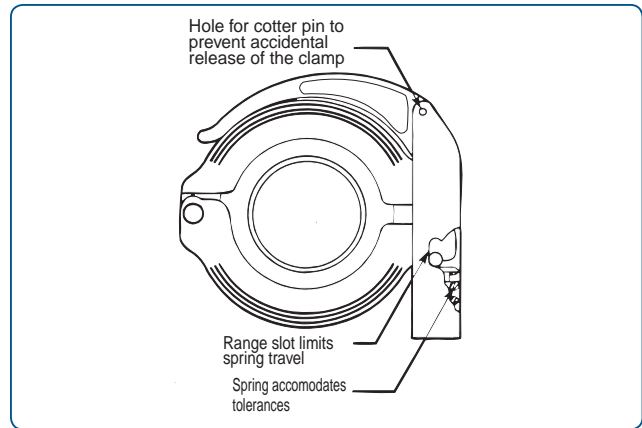

Figure 3 —
Toggle Clamp

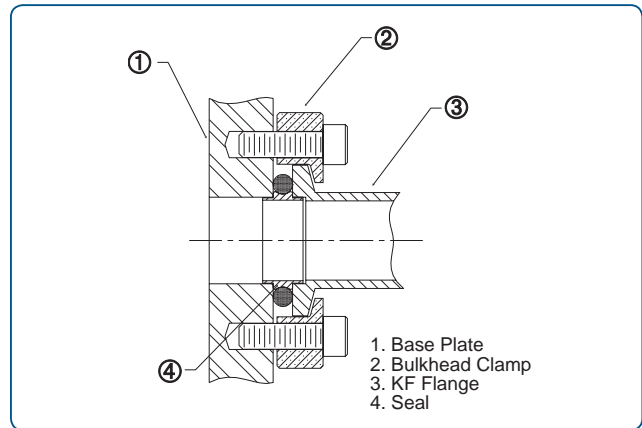

Figure 4 —
Bulkhead Clamp

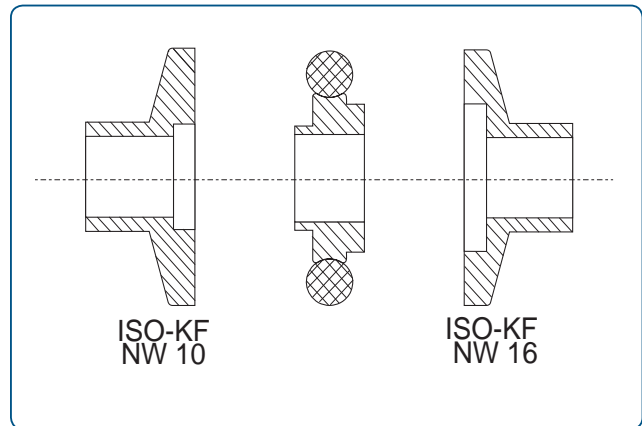

Figure 5 —
Adaptive Centering Rings



Brass flanges, stub or socket types, are tolerated for silver brazing where clearances of a few thousandths of an inch are optimal for alloy flow. Brass components may be soft soldered. However, it is much more difficult to make leak free assemblies by soft soldering than by silver brazing. Soft soldering has little strength, and the assemblies cannot be cleaned by immersion in a chemical bright dip.

If system pressures are in the positive pressure range, it is recommended that over pressure rings are used. The

ISO-KF over pressure rings are installed differently by size. The NW 16, 25, and 40 ISO-KF rings are installed over the two ISO-KF flanges. The NW 10 and 50 ISO-KF rings are installed between the two flange faces. The clamp is installed around all items to secure the assembly (see Figures 6 and 6a).

For more information, contact Customer Service at 1-800-345-1967 or 303-449-9861.

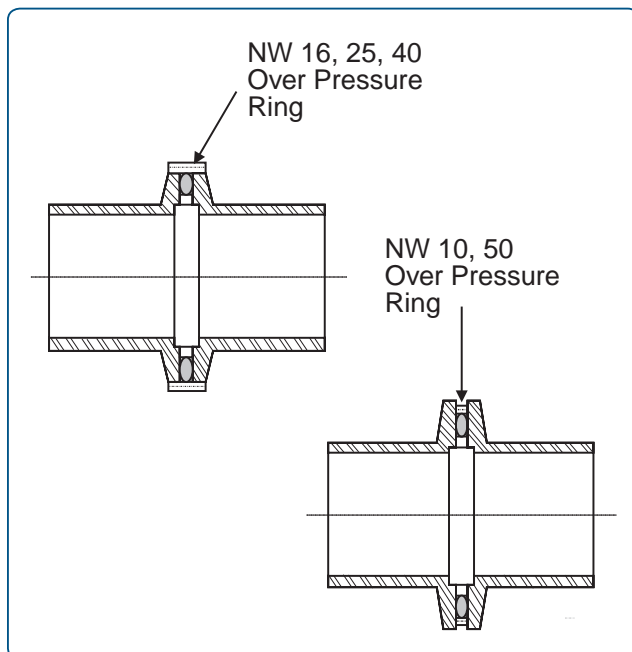

Figure 6 —
Overpressure Rings

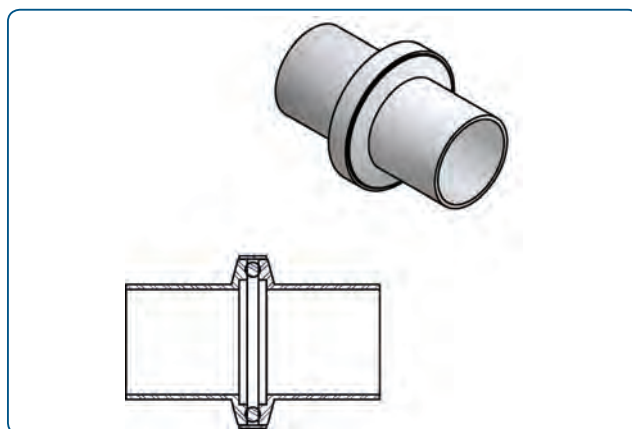

Figure 6a —
Captured O-Ring Overpressure Assembly

Elastomer Comparison			
	Buna-N	Viton®	Silicone
Compound	N674-70	V747-75	S604-70
Color	Black	Black	Rust
Bakeout	80°C	150°C	185°C
Benefits	Seals easier, lower cost	Chemical resistance, lasts longer	High temperature

Specifications	
Maximum Pressure (with overpressure ring)	NW 10-25: 100 psig NW 40: 75 psig NW50: 50 psig
Minimum Pressure	10 ⁻⁹ Torr
Leak Check	<10 ⁻⁹ std-cc/s
Materials	
Fittings	304 Stainless Steel Yellow Brass 6061T6 Aluminum (316 Stainless is available on request)
Clamps	Aluminum
Over Pressure Rings	Stainless Steel
Seal Assembly	Choice of aluminum or stainless steel centering ring; Choice of Viton®, Silicone, or Buna-N elastomer seal

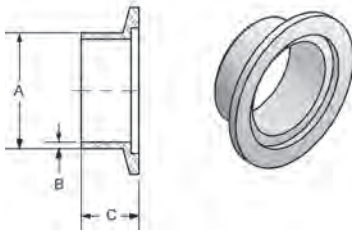

Ordering Information

Flange, Short Weld Stub, Stainless Steel							in./(mm)
 <ul style="list-style-type: none"> Stainless Steel Type 304 Buttweld Standard Inch Stub Diameters 	Flange Size (ISO)	For Tubing OD	A	B	C	Part Number	
	NW 10	1/2"	0.50 (13)	0.065 (1.7)	0.50 (13)	100310300	
	NW 16	1/2"	0.50 (13)	0.065 (1.7)	0.50 (13)	100310301	
	NW 16	3/4"	0.75 (19)	0.065 (1.7)	0.50 (13)	100310311	
	NW 25	1"	1.00 (25)	0.065 (1.7)	0.50 (13)	100310303	
	NW 40	1 1/2"	1.50 (38)	0.065 (1.7)	0.75 (19)	100310305	
	NW 50	2"	2.00 (51)	0.065 (1.7)	0.75 (19)	100310306	

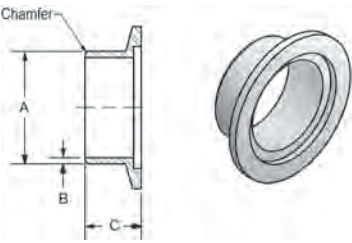
Flange, Short Weld Stub, Aluminum							in./(mm)
 <ul style="list-style-type: none"> Aluminum Type 6061T6 Buttweld Standard Inch Stub Diameters 	Flange Size (ISO)	For Tubing OD	A	B	C	Part Number	
	NW 16	1/2"	0.50 (13)	0.065 (1.7)	0.50 (13)	100310101	
	NW 16	3/4"	0.75 (19)	0.065 (1.7)	0.50 (13)	100310111	
	NW 25	1"	1.00 (25)	0.065 (1.7)	0.50 (13)	100310103	
	NW 40	1 1/2"	1.50 (38)	0.083 (2.1)	0.75 (19)	100310105	
	NW 50	2"	2.00 (51)	0.083 (2.1)	0.75 (19)	100310106	

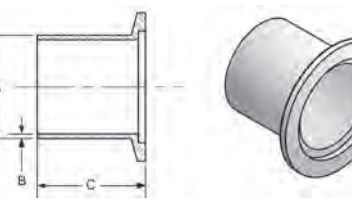
Flange, Long Weld Stub, Stainless Steel							in./(mm)
 <ul style="list-style-type: none"> Stainless Steel Type 304 Buttweld Standard Inch Stub Diameters 	Flange Size (ISO)	For Tubing OD	A	B	C	Part Number	
	NW 10	1/2"	0.50 (13)	0.065 (1.7)	1.58 (40)	100315700	
	NW 16	1/2"	0.50 (13)	0.065 (1.7)	1.58 (40)	100315701	
	NW 16	3/4"	0.75 (19)	0.065 (1.7)	1.58 (40)	100315711	
	NW 25	1"	1.00 (25)	0.065 (1.7)	1.58 (40)	100315703	
	NW 40	1 1/2"	1.50 (38)	0.065 (1.7)	1.58 (40)	100315705	
	NW 50	2"	2.00 (51)	0.065 (1.7)	1.58 (40)	100315706	

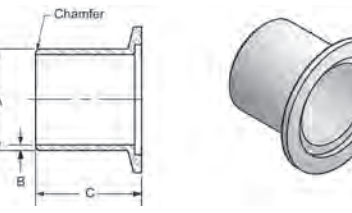
Flange, Long Weld Stub, Aluminum							in./(mm)
 <ul style="list-style-type: none"> Aluminum Type 6061T6 Standard Inch Stub Diameters 	Flange Size (ISO)	For Tubing OD	A	B	C	Part Number	
	NW 16	1/2"	0.50 (13)	0.065 (1.7)	1.58 (40)	100310201	
	NW 16	3/4"	0.75 (19)	0.065 (1.7)	1.58 (40)	100310211	
	NW 25	1"	1.00 (25)	0.065 (1.7)	1.58 (40)	100310203	
	NW 40	1 1/2"	1.50 (38)	0.083 (2.1)	1.58 (40)	100310205	
	NW 50	2"	2.00 (51)	0.083 (2.1)	1.58 (40)	100310206	



Flange, Weld Socket, Stainless Steel

in./(mm)

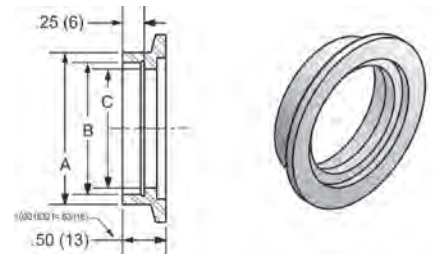
	Flange Size (ISO)	For Tubing OD	A	B	C	Part Number
	<ul style="list-style-type: none"> Stainless Steel Type 304 Self Aligning Standard Tube Weld Prep. Also Suitable for Buttweld 	NW 16	1/2"	0.61 (15)	0.51 (13)	0.45 (11)
	NW 16	5/8"	0.77 (20)	0.64 (16)	0.58 (15)	100318311
	NW 16	3/4"	0.87 (22)	0.76 (19)	0.68 (17)	100318321
	NW 25	1"	1.13 (29)	1.02 (26)	0.87 (22)	100318303
	NW 40	1 1/2"	1.75 (44)	1.50 (38)	1.37 (35)	100318305
	NW 50	2"	2.25 (57)	2.02 (51)	1.87 (47)	100318306

Flange, Blank with Bore, Stainless Steel

in./(mm)

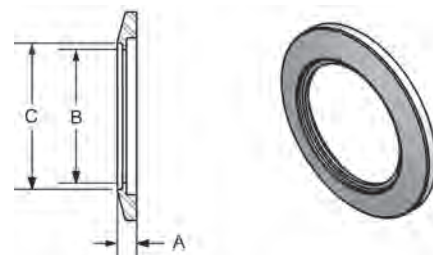
	Flange Size (ISO)	For Tubing OD	A	B	C	Part Number
	<ul style="list-style-type: none"> Stainless Steel Type 304 Standard Inch Tube OD's 	NW 10	1/4"	0.20 (5)	0.26 (7)	N/A
	NW 10	3/8"	0.20 (5)	0.39 (10)	N/A	100319720
	NW 10	1/2"	0.20 (5)	0.44 (11)	0.51 (13)	100319700
	NW 16	1/4"	0.20 (5)	0.26 (7)	N/A	100319711
	NW 16	3/8"	0.20 (5)	0.39 (10)	N/A	100319721
	NW 16	1/2"	0.20 (5)	0.51 (13)	N/A	100319731
	NW 16	3/4"	0.20 (5)	0.68 (17)	0.76 (19)	100319701
	NW 25	1/4"	0.20 (5)	0.26 (7)	N/A	100319713
	NW 25	3/8"	0.20 (5)	0.39 (10)	N/A	100319723
	NW 25	1/2"	0.20 (5)	0.51 (13)	N/A	100319733
	NW 25	3/4"	0.20 (5)	0.63 (16)	0.76 (19)	100319743
	NW 25	1"	0.20 (5)	0.89 (23)	1.02 (26)	100319703
	NW 40	1/4"	0.20 (5)	0.26 (7)	N/A	100319715
	NW 40	3/8"	0.20 (5)	0.39 (10)	N/A	100319725
	NW 40	1/2"	0.20 (5)	0.51 (13)	N/A	100319735
	NW 40	3/4"	0.20 (5)	0.63 (16)	0.76 (19)	100319745
	NW 40	1"	0.20 (5)	0.89 (23)	1.02 (26)	100319755
	NW 40	1 1/2"	0.20 (5)	1.39 (35)	1.52 (39)	100319705
	NW 50	1/4"	0.20 (5)	0.26 (7)	N/A	100319716
	NW 50	3/8"	0.20 (5)	0.39 (10)	N/A	100319726
	NW 50	1/2"	0.20 (5)	0.51 (13)	N/A	100319736
	NW 50	3/4"	0.20 (5)	0.63 (16)	0.76 (19)	100319746
	NW 50	1"	0.20 (5)	0.89 (23)	1.02 (26)	100319756
	NW 50	1 1/2"	0.20 (5)	1.39 (35)	1.52 (39)	100319766
	NW 50	2"	0.20 (5)	1.89 (48)	2.02 (51)	100319706

Flange, Blank with Bore, KF 80 / KF 100, Stainless Steel

in./(mm)

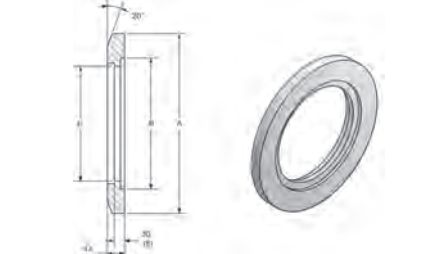
	Flange Size (ISO)	For Tubing OD	A	B	C	Part Number
	<ul style="list-style-type: none"> Stainless Steel Type 304 	NW 80	3"	4.49 (114)	3.27 (83)	2.90 (74)
	NW 100	4"	5.28 (134)	4.02 (102)	3.87 (98)	100319803

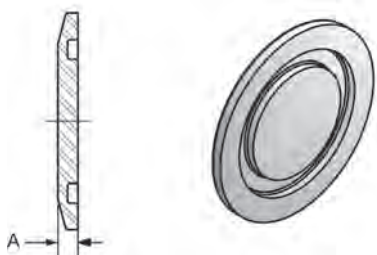

Ordering Information

Flange, Blank-Off, Stainless Steel			in./(mm)
 <ul style="list-style-type: none"> Stainless Steel Type 304 To Close Off Unused Ports 	Flange Size (ISO)	A	Part Number
	NW 10	0.20 (5)	100311700
	NW 16	0.20 (5)	100311701
	NW 25	0.20 (5)	100311703
	NW 40	0.20 (5)	100311705
	NW 50	0.20 (5)	100311706
	NW 80	0.43 (11)	100319802
NW 100	0.43 (11)	100319804	

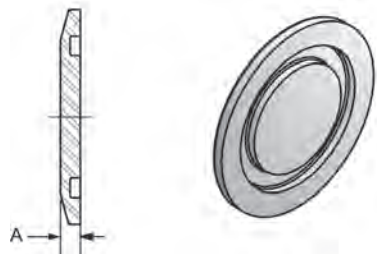
Flange, Blank-Off, Aluminum			in./(mm)
 <ul style="list-style-type: none"> Aluminum Alloy To Close Off Unused Ports 	Flange Size (ISO)	A	Part Number
	NW 10	0.20 (5)	100311600
	NW 16	0.20 (5)	100311601
	NW 25	0.20 (5)	100311603
	NW 40	0.20 (5)	100311605
NW 50	0.20 (5)	100311606	

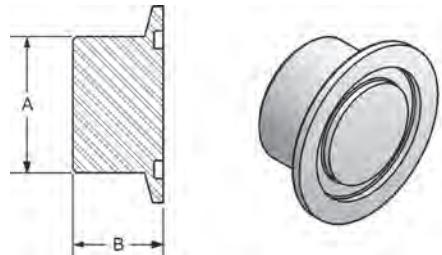
Flange, Unbored Stub, Stainless Steel				in./(mm)
 <ul style="list-style-type: none"> Stainless Steel Type 304 Stub may be turned, bored or tapped to fit 	Flange Size (ISO)	A	B	Part Number
	NW 10	0.75 (19)	0.75 (19)	100311300
	NW 16	0.75 (19)	0.75 (19)	100311301
	NW 25	1.00 (25)	0.75 (19)	100311303
	NW 40	1.50 (38)	1.00 (25)	100311305
NW 50	2.00 (51)	1.00 (25)	100311306	

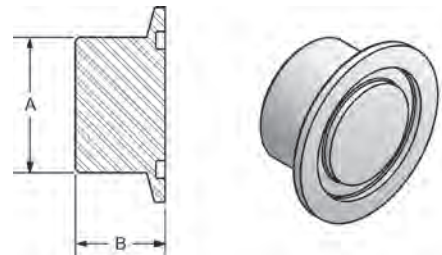
Flange, Unbored Stub, Aluminum				in./(mm)
 <ul style="list-style-type: none"> Aluminum Type 6061T6 Stub may be turned, bored or tapped to fit 	Flange Size (ISO)	A	B	Part Number
	NW 10	0.75 (19)	0.75 (19)	100311100
	NW 16	0.75 (19)	0.75 (19)	100311101
	NW 25	1.00 (25)	0.75 (19)	100311103
	NW 40	1.50 (38)	1.00 (25)	100311105
NW 50	2.00 (51)	1.00 (25)	100311106	

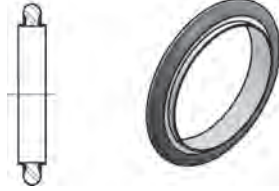

Seal, Centering Ring Assembly, Stainless Steel/Viton® **in./(mm)**

 <ul style="list-style-type: none"> • 180°C Max • Replaceable O-Ring • NW 80/100 includes aluminum spacer ring 	Flange Size (ISO)	Part Number
	NW 10 NW 16 NW 25 NW 40 NW 50 NW 80 NW 100	100312700 100312701 100312703 100312705 100312706 100760508 100760510

Seal, Centering Ring Assembly, Aluminum/Viton® **in./(mm)**

 <ul style="list-style-type: none"> • 180°C Max • Replaceable O-Ring • NW 80/100 includes aluminum spacer ring 	Flange Size (ISO)	Part Number
	NW 10 NW 16 NW 25 NW 40 NW 50 NW 80 NW 100	100312600 100312601 100312603 100312605 100312606 100760608 100760610

Seal, Centering Ring Assembly, Stainless Steel/Buna-N **in./(mm)**

 <ul style="list-style-type: none"> • 80°C Max • Replaceable O-Ring 	Flange Size (ISO)	Part Number
	NW 10 NW 16 NW 25 NW 40 NW 50	100312800 100312801 100312803 100312805 100312806

Seal, Centering Ring Assembly, Aluminum/Buna-N **in./(mm)**

 <ul style="list-style-type: none"> • 80°C Max • Replaceable O-Ring • NW 80/100 includes aluminum spacer ring 	Flange Size (ISO)	Part Number
	NW 10 NW 16 NW 25 NW 40 NW 50 NW 80 NW 100	100312500 100312501 100312503 100312505 100312506 100760708 100760710

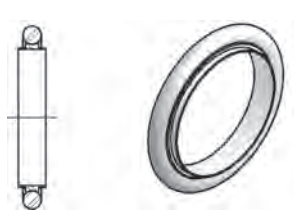

Ordering Information

Seal, Centering Ring Assembly, Stainless Steel/Silicone		in./ (mm)
 <ul style="list-style-type: none"> • 200°C Max • Replaceable O-Ring 	Flange Size (ISO)	Part Number
	NW 10 NW 16 NW 25 NW 40 NW 50	100317300 100317301 100317303 100317305 100317306

Seal, Centering Ring Assembly Overpressure, Stainless Steel/Viton		in./ (mm)
 <ul style="list-style-type: none"> • Stainless Steel Centering Ring • Replaceable Viton O-Ring • Includes Aluminum Overpressure Ring 	Flange Size (ISO)	Part Number
	NW 25 NW 40 NW 50	100936525 100936524 100936523

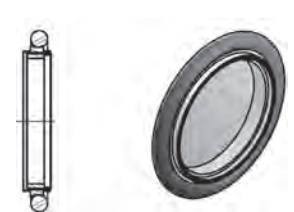
Seal, Centering Ring Assembly, w/Screen, Stainless Steel/Viton®		in./ (mm)
 <ul style="list-style-type: none"> • Stainless Steel Centering Ring • Replaceable Viton O-Ring • 72 Mesh Screen Stainless Steel 	Flange Size (ISO)	Part Number
	NW 16 NW 25 NW 40 NW 50	100318601 100318603 100318605 100318606

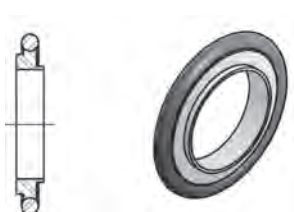
Seal, Adaptive Centering Ring Assembly, Stainless Steel/Viton			in./ (mm)
 <ul style="list-style-type: none"> • Stainless Steel Centering Ring • Replaceable Viton O-Ring • For Obsolete Bore Sizes 	Flange Size (ISO)	Flange Size (ISO)	Part Number
	NW 16 NW 25 NW 40	NW 10 NW 20 NW 32	100315821 100315823 100315825



Seal, Adaptive Centering Ring Assembly, Aluminum/Viton in./(mm)

 <ul style="list-style-type: none"> • Replaceable Viton O-Ring • For Obsolete Bore Sizes 	Flange Size (ISO)	Flange Size (ISO)	Part Number
	NW 16 NW 25 NW 40	NW 10 NW 20 NW 32	100315811 100315813 100315815

Seal, Adaptive Centering Ring Assembly, Aluminum/Buna-N in./(mm)

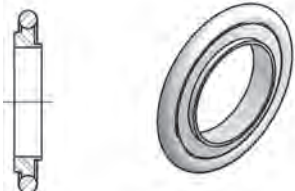
 <ul style="list-style-type: none"> • Replaceable O-Ring • For Obsolete Bore Sizes 	Flange Size (ISO)	Flange Size (ISO)	Part Number
	NW 16 NW 25 NW 40	NW 10 NW 20 NW 32	100315801 100315803 100315805

Seal, Replacement O-Ring, Viton® in./(mm)

 <ul style="list-style-type: none"> • Standard Inch O-Ring Sizes 	Flange Size (ISO)	Standard O-Ring Size	Part Number
	NW 10 NW 16 NW 25 NW 40 NW 50 NW 80 NW 100	2-312 2-314 2-320 2-326 2-330 2-340 2-346	100314000 100314001 100314003 100314005 100314006 100762008 100762010

Seal, Replacement O-Ring, Buna-N in./(mm)

 <ul style="list-style-type: none"> • Standard Inch O-Ring Sizes 	Flange Size (ISO)	Standard O-Ring Size	Part Number
	NW 10 NW 16 NW 25 NW 40 NW 50 NW 80 NW 100	2-312 2-314 2-320 2-326 2-330 2-340 2-346	100313900 100313901 100313903 100313905 100313906 100761908 100761910



Ordering Information

Seal, Replacement O-Ring, Silicone			in./(mm)
 <ul style="list-style-type: none"> Standard Inch O-Ring Sizes 	Flange Size (ISO)	Standard O-Ring Size	Part Number
	NW 10 NW 16 NW 25 NW 40 NW 50	2-312 2-314 2-320 2-326 2-330	100317310 100317311 100317313 100317315 100317316

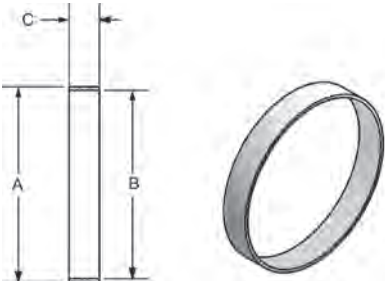
Ring, Overpressure						in./(mm)
 <ul style="list-style-type: none"> Stainless Steel Fits over OD of O-ring Use to retain O-ring when system is used at internal pressures over atmospheric 	Flange Size (ISO)	Max. Pressure	A	B	C	Part Number
	NW 16 NW 25 NW 40 NW 50	100 psig 100 psig 75 psig 50 psig	1.25 (31) 1.66 (42) 2.25 (57) 2.75 (70)	1.19 (30) 1.58 (40) 2.17 (55) 2.66 (68)	0.35 (9) 0.35 (9) 0.35 (9) 0.14 (4)	100316301 100316303 100316305 100316306

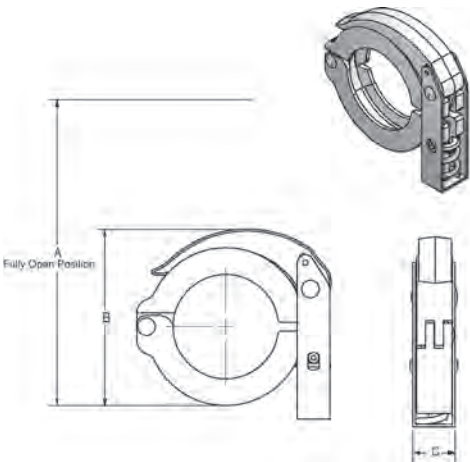
Clamp, Toggle						in./(mm)
 <ul style="list-style-type: none"> Aluminum Quick Operating Positive Locking Method Self Adjusting Cannot Be Over-tightened 	Flange Size (ISO)	Fits Sizes	A	B	C	Part Number
	NW 16 NW 25 NW 40 NW 50	16/10 25/20 40/32 50	4.05 (103) 4.31 (109) 4.87 (124) 6.34 (161)	2.50 (64) 2.96 (75) 3.29 (84) 4.73 (120)	0.75 (19) 0.75 (19) 0.75 (19) 0.89 (23)	100318801 100318803 100318805 100318806



Clamp, Toggle w/Lanyard

in./(mm)

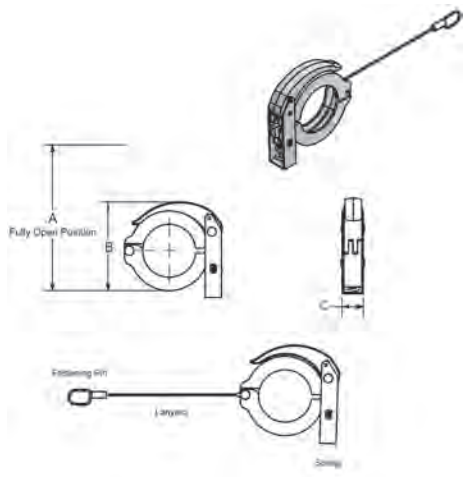
	Flange Size (ISO)	Fits Sizes	A	B	C	Part Number
	<ul style="list-style-type: none"> Aluminum Fastening pin on lanyard prevents accidental opening and pin loss Positive locking method Self-adjusting Heavy duty spring supports the full range of production tolerance variables 	NW 16	16/10	4.05 (103)	2.50 (64)	0.75 (19)
	NW 25	25/20	4.31 (109)	2.96 (75)	0.75 (19)	100318803-L
	NW 40	40/32	4.87 (124)	3.29 (84)	0.75 (19)	100318805-L
	NW 50	50	6.34 (161)	4.73 (120)	0.89 (23)	100318806-L

Clamp, Wing Nut

in./(mm)

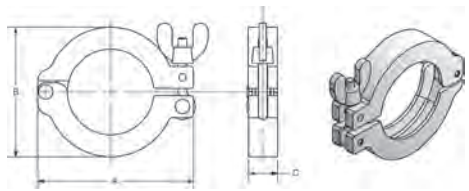
	Flange Size (ISO)	Fits Sizes	A	B	C	Part Number
	<ul style="list-style-type: none"> Aluminum 70 inch-pounds max torque 	NW 16	16/10	2.24 (57)	1.69 (43)	0.63 (16)
	NW 25	25/20	2.76 (70)	2.17 (55)	0.63 (16)	100312903
	NW 40	40/32	3.39 (86)	2.76 (70)	0.63 (16)	100312905
	NW 50	50	4.33 (110)	3.70 (94)	0.79 (20)	100312906

Clamp, Bulkhead

in./(mm)

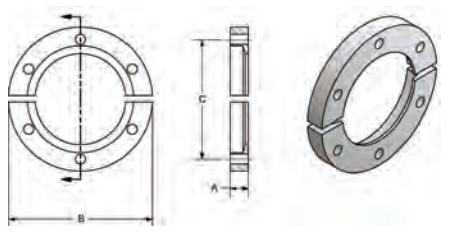
	Flange Size (ISO)	Number of Bolts	A	B	C	Part Number
	<ul style="list-style-type: none"> Aluminum Adapts to a baseplate or fixed flange Standard KF seal assembly Stainless steel bolts and washers included, 10-32 x 5/8" 	NW 16	6	0.36 (9)	2.00 (51)	1.50 (38)
	NW 25	6	0.39 (10)	2.38 (60)	1.89 (48)	100318903
	NW 40	6	0.37 (9)	2.94 (75)	2.44 (62)	100318905
	NW 50	8	0.40 (10)	3.75 (95)	3.25 (83)	100318906

Clamp, Chain

in./(mm)

<ul style="list-style-type: none"> For use with KF 80 and 100 flanges Aluminum 	Flange Size (ISO)	Part Number
		NW 80
	NW 100	100994717

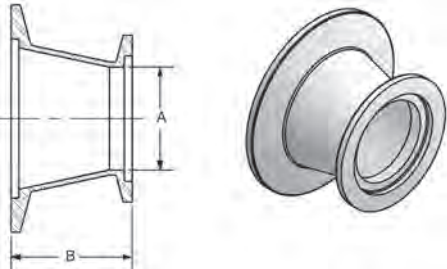

Ordering Information

Conical Reducer, Stainless Steel					in./(mm)
	Flange Size (ISO)	Flange Size (ISO)	A	B	Part Number
	NW 16	NW 25	0.62 (16)	1.57 (40)	100313711
	NW 16	NW 40	0.62 (16)	1.57 (40)	100313712
	NW 16	NW 50	0.62 (16)	1.57 (40)	100313713
	NW 25	NW 40	0.87 (22)	1.57 (40)	100313714
	NW 25	NW 50	0.87 (22)	1.57 (40)	100313715
	NW 40	NW 50	1.34 (34)	1.57 (40)	100313716

• Mates differing ISO-KF flange sizes

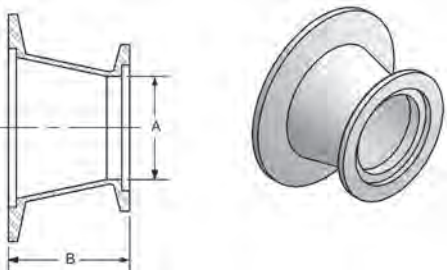
Conical Reducer, Aluminum					in./(mm)
	Flange Size (ISO)	Flange Size (ISO)	A	B	Part Number
	NW 16	NW 25	0.62 (16)	1.57 (40)	100313511
	NW 16	NW 40	0.62 (16)	1.57 (40)	100313512
	NW 16	NW 50	0.62 (16)	1.57 (40)	100313513
	NW 25	NW 40	0.87 (22)	1.57 (40)	100313514
	NW 25	NW 50	0.87 (22)	1.57 (40)	100313515
	NW 40	NW 50	1.34 (34)	1.57 (40)	100313516

• Mates differing ISO-KF flange sizes

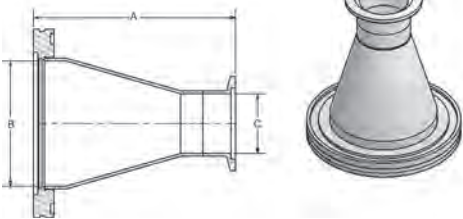
Conical Adapter, ISO-MF to ISO-KF					in./(mm)
	Flange Size (ISO)	A	B	C	Part Number
	NW 63 to NW 40	3.39 (86)	2.37 (60)	1.37 (35)	100765006
	NW 63 to NW 50	3.39 (86)	2.37 (60)	1.87 (47)	100765017
	NW 80 to NW 40	4.64 (118)	2.87 (73)	1.37 (35)	100765016
	NW 80 to NW 50	4.64 (118)	2.87 (73)	1.87 (47)	100765008
	NW 100 to NW 50	4.64 (118)	3.83 (97)	1.87 (47)	100765018

• Stainless Steel Type 304
 • High conductance adapter
 • Special adapters available upon request



Step Adapter, ISO-MF to ISO-KF

in./(mm)

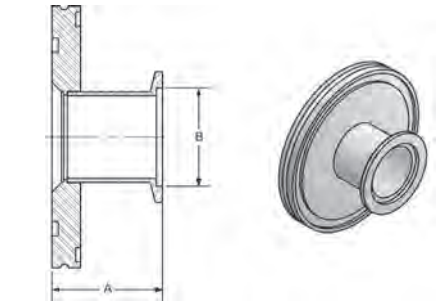
 <ul style="list-style-type: none"> Stainless Steel Type 304 	Flange Size (ISO)	A	B	Part Number
	NW 63 to NW 40	1.77 (45)	1.37 (35)	100762606
	NW 63 to NW 50	1.77 (45)	1.87 (47)	100762617
	NW 80 to NW 40	1.77 (45)	1.87 (47)	100762616
	NW 80 to NW 50	1.77 (45)	1.87 (47)	100762608
	NW 100 to NW 40	1.77 (45)	1.37 (35)	100762620
	NW 100 to NW 50	1.77 (45)	1.87 (47)	100762618

Adapter, ISO-KF to CF

in./(mm)

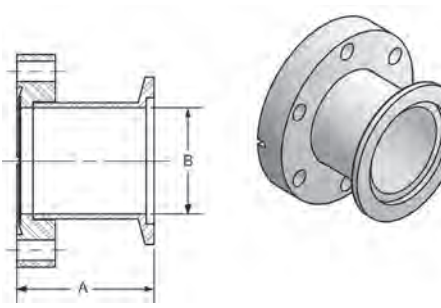
 <ul style="list-style-type: none"> Stainless Steel Type 304 	Flange Size (KF)	Flange Size (CF)	A	B	Part Number
	NW 16	Mini 1 1/3"	2.08 (53)	0.62 (16)	100315601
	NW 16	2 3/4"	1.78 (45)	0.62 (16)	100315611
	NW 25	2 1/8"	1.89 (48)	0.87 (22)	100319812
	NW 25	2 3/4"	1.78 (45)	0.87 (22)	100315603
	NW 40	2 3/4"	1.78 (45)	1.33 (34)	100315605
	NW 50	2 3/4"	2.11 (54)	1.37 (35)	100319813
	NW 50	4 1/2"	1.95 (50)	1.83 (46)	100315606

Adapter, ISO-KF to ASA, without O-Ring Groove

in./(mm)

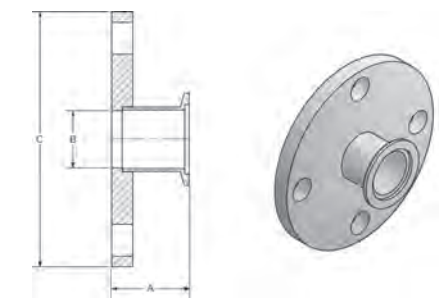
 <ul style="list-style-type: none"> Stainless Steel Type 304 Without O-Ring Groove 	Flange Size (KF)	Flange Size (ASA)	A	B	C	Part Number
	NW 40	1 1/2"	1.81 (46)	1.33 (34)	5.00 (127)	100316755
	NW 40	2"	1.81 (46)	1.33 (34)	6.00 (152)	100316705
	NW 40	3"	1.81 (46)	1.33 (34)	7.50 (191)	100316715
	NW 50	1 1/2"	1.81 (46)	1.83 (46)	5.00 (127)	100316756
	NW 50	2"	1.81 (46)	1.83 (46)	6.00 (152)	100316706
	NW 50	3"	1.81 (46)	1.83 (46)	7.50 (191)	100316716

Adapter, ISO-KF to ASA, with O-Ring Groove

in./(mm)

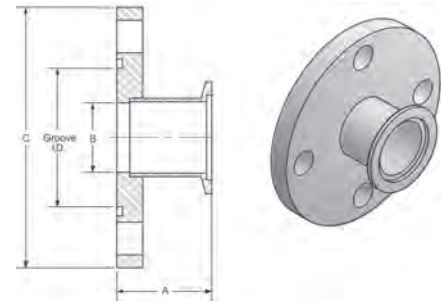
 <ul style="list-style-type: none"> Stainless Steel Type 304 With O-ring Groove 	Flange Size (KF)	Flange Size (ASA)	Groove ID (O-Ring)	A	B	C	Part Number
	NW 40	1 1/2"	2.66" (2-231)	1.81 (46)	1.33 (34)	5.00 (127)	100316775
	NW 40	2"	3.42" (2-237)	1.81 (46)	1.33 (34)	6.00 (152)	100316725
	NW 40	3"	4.69" (2-247)	1.81 (46)	1.33 (34)	7.50 (191)	100316735
	NW 50	1 1/2"	2.66" (2-231)	1.81 (46)	1.83 (46)	5.00 (127)	100316776
	NW 50	2"	3.42" (2-237)	1.81 (46)	1.83 (46)	6.00 (152)	100316726
	NW 50	3"	4.69" (2-247)	1.81 (46)	1.83 (46)	7.50 (191)	100316736



Ordering Information

ASA O-Ring, Viton®		in./(mm)	
	Flange Size (ASA)	O-Ring	Part Number
		1 1/2" 2" 3"	2-231 2-237 2-247

Adapter, ISO-KF to NPT-F Pipe, Stainless Steel					in./(mm)
 <ul style="list-style-type: none"> • Teflon Tape recommended to seal • Compatible with most TC and Pirani tubes 	Flange Size (KF)	Flange Size (NPT)	A	B	Part Number
	NW 10	1/8"	0.62 (16)	0.75 (19)	100312100
	NW 10	1/4"	0.62 (16)	0.75 (19)	100312300
	NW 16	1/8"	0.62 (16)	0.75 (19)	100312101
	NW 16	1/4"	0.62 (16)	0.75 (19)	100312301
	NW 25	1/8"	0.88 (22)	0.75 (19)	100312103
	NW 25	1/4"	0.88 (22)	0.75 (19)	100312303
	NW 40	1/8"	1.25 (32)	1.00 (25)	100312105
	NW 40	1/4"	1.25 (32)	1.00 (25)	100312305
	NW 50	1/8"	1.75 (44)	1.00 (25)	100312106
NW 50	1/4"	1.75 (44)	1.00 (25)	100312306	

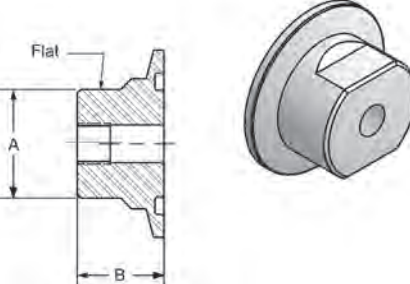
Adapter, ISO-KF to NPT-F Pipe, Aluminum					in./(mm)
 <ul style="list-style-type: none"> • Teflon Tape recommended to seal • Compatible with most TC and Pirani tubes 	Flange Size (KF)	Flange Size (NPT)	A	B	Part Number
	NW 10	1/8"	0.62 (16)	0.75 (19)	100312000
	NW 10	1/4"	0.62 (16)	0.75 (19)	100312200
	NW 16	1/8"	0.62 (16)	0.75 (19)	100312001
	NW 16	1/4"	0.62 (16)	0.75 (19)	100312201
	NW 25	1/8"	0.88 (22)	0.75 (19)	100312003
	NW 25	1/4"	0.88 (22)	0.75 (19)	100312203
	NW 40	1/8"	1.25 (32)	1.00 (25)	100312005
	NW 40	1/4"	1.25 (32)	1.00 (25)	100312205
	NW 50	1/8"	1.75 (44)	1.00 (25)	100312006
NW 50	1/4"	1.75 (44)	1.00 (25)	100312206	



Adapter, ISO-KF to NPT-M Pipe, Stainless Steel in./(mm)

 <ul style="list-style-type: none"> • Stainless Steel • Hex Shank • Tapered Thread • Teflon Tape recommended to seal 	Flange Size (KF)	Flange Size (NPT)	A	B	Part Number
	NW 16	1/8"	1.57 (40)	0.19 (5)	100316801
NW 16	1/4"	1.97 (50)	0.26 (7)	100316811	
NW 25	1/8"	1.57 (40)	0.19 (5)	100316803	
NW 25	1/4"	1.97 (50)	0.26 (7)	100316813	
NW 25	1/2"	2.95 (75)	0.45 (11)	100316823	
NW 25	3/4"	2.95 (75)	0.78 (20)	100316833	
NW 40	1/4"	1.97 (50)	0.26 (7)	100316805	
NW 40	1/2"	2.95 (75)	0.45 (11)	100316815	
NW 40	3/4"	2.95 (75)	0.78 (20)	100316825	
NW 40	1"	2.95 (75)	0.88 (22)	100316835	
NW 40	1 1/4"	2.00 (51)	1.12 (28)	100316844	
NW 40	1 1/2"	2.00 (51)	1.34 (34)	100316845	
NW 50	1/4"	1.97 (50)	0.26 (7)	100316806	
NW 50	1/2"	2.95 (75)	0.45 (11)	100316816	
NW 50	3/4"	2.95 (75)	0.78 (20)	100316826	
NW 50	1"	2.95 (75)	0.88 (22)	100316836	
NW 50	2"	2.00 (51)	1.87 (47)	100316846	

Adapter Tee, ISO-KF to NPT-F Pipe, Stainless Steel in./(mm)

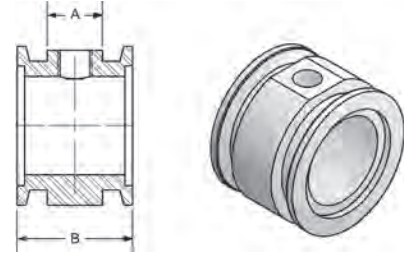
 <ul style="list-style-type: none"> • Available with additional NPT holes • Teflon Tape recommended to seal 	Flange Size (KF)	Flange Size (NPT)	A	B	Part Number
	NW 16	1/8" Tapped	0.76 (19)	1.57 (40)	100319401
NW 16	1/4" Tapped	0.76 (19)	1.57 (40)	100319601	
NW 25	1/8" Tapped	0.76 (19)	1.57 (40)	100319403	
NW 25	1/4" Tapped	0.76 (19)	1.57 (40)	100319603	
NW 40	1/8" Tapped	0.76 (19)	1.57 (40)	100319405	
NW 40	1/4" Tapped	0.76 (19)	1.57 (40)	100319605	
NW 50	1/8" Tapped	0.76 (19)	1.57 (40)	100319406	
NW 50	1/4" Tapped	0.76 (19)	1.57 (40)	100319606	

Adapter Tee, ISO-KF to NPT-F Pipe, Aluminum in./(mm)

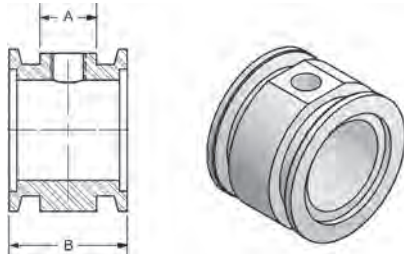
 <ul style="list-style-type: none"> • Available with additional NPT holes • Teflon Tape recommended to seal 	Flange Size (KF)	Flange Size (NPT)	A	B	Part Number
	NW 16	1/8" Tapped	0.76 (19)	1.57 (40)	100319301
NW 16	1/4" Tapped	0.76 (19)	1.57 (40)	100319501	
NW 25	1/8" Tapped	0.76 (19)	1.57 (40)	100319303	
NW 25	1/4" Tapped	0.76 (19)	1.57 (40)	100319503	
NW 40	1/8" Tapped	0.76 (19)	1.57 (40)	100319305	
NW 40	1/4" Tapped	0.76 (19)	1.57 (40)	100319505	
NW 50	1/8" Tapped	0.76 (19)	1.57 (40)	100319306	
NW 50	1/4" Tapped	0.76 (19)	1.57 (40)	100319506	

Adapter, ISO-KF to Rubber Hose in./(mm)

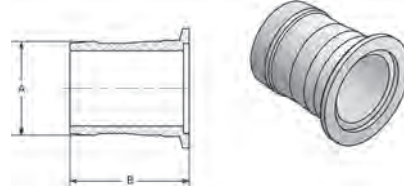
 <ul style="list-style-type: none"> • Aluminum • Compatible with standard vacuum hose bores 	Flange Size (ISO)	Hose Size	A	B	Part Number
	NW 16	1/2" or 5/8"	0.63 (16)	1.65 (42)	100311811
NW 16	5/8" or 3/4"	0.75 (19)	1.65 (42)	100311801	
NW 25	3/4" or 7/8"	0.88 (22)	1.73 (44)	100311803	
NW 40	1 1/2" or 1 5/8"	1.63 (41)	2.17 (55)	100311805	
NW 50	1 1/2" or 1 5/8"	1.63 (41)	2.17 (55)	100311806	

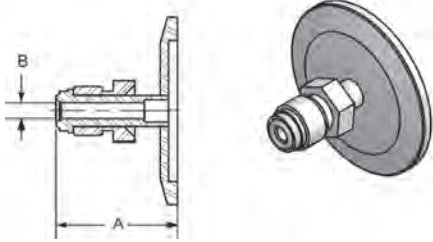

Ordering Information

Adapter, ISO-KF to VCR®-M						in./(mm)
 <ul style="list-style-type: none"> Stainless Steel 	Flange Size (ISO)	Flange Size (VCR)	A	B	VCR Size	Part Number
	NW 16	4 VCR	1.40 (36)	0.19 (5)	1/4"	100319111
	NW 16	8 VCR	1.63 (41)	0.41 (10)	1/2"	100319121
	NW 25	4 VCR	1.40 (36)	0.19 (5)	1/4"	100319113
	NW 25	8 VCR	1.60 (41)	0.41 (10)	1/2"	100319123
	NW 25	12 VCR	2.14 (54)	0.62 (16)	3/4"	100319133
	NW 40	4 VCR	1.40 (36)	0.19 (5)	1/4"	100319115
	NW 40	8 VCR	1.60 (41)	0.41 (10)	1/2"	100319125
	NW 40	12 VCR	2.10 (53)	0.62 (16)	3/4"	100319135
	NW 50	4 VCR	1.40 (36)	0.19 (5)	1/4"	100319116
	NW 50	8 VCR	1.60 (41)	0.41 (10)	1/2"	100319126
	NW 50	12 VCR	2.10 (53)	0.62 (16)	3/4"	100319136

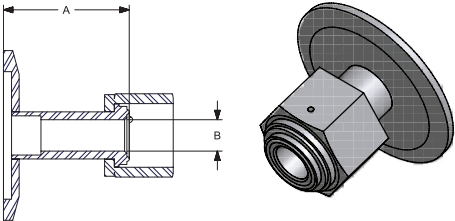
Adapter, ISO-KF to VCR®-F						in./(mm)
 <ul style="list-style-type: none"> Stainless Steel 	Flange Size (ISO)	Flange Size (VCR)	A	B	VCR Size	Part Number
	NW 16	4 VCR	1.40 (36)	0.19 (5)	1/4"	100319211
	NW 16	8 VCR	1.63 (41)	0.41 (10)	1/2"	100319221
	NW 25	4 VCR	1.40 (36)	0.19 (5)	1/4"	100319213
	NW 25	8 VCR	1.60 (41)	0.41 (10)	1/2"	100319223
	NW 25	12 VCR	2.14 (54)	0.62 (16)	3/4"	100319233
	NW 40	4 VCR	1.40 (36)	0.19 (5)	1/4"	100319215
	NW 40	8 VCR	1.60 (41)	0.41 (10)	1/2"	100319225
	NW 40	12 VCR	2.10 (53)	0.62 (16)	3/4"	100319235
	NW 50	4 VCR	1.40 (36)	0.19 (5)	1/4"	100319216
	NW 50	8 VCR	1.60 (41)	0.41 (10)	1/2"	100319226
	NW 50	12 VCR	2.10 (53)	0.62 (16)	3/4"	100319236

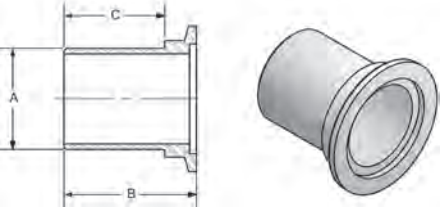
Adapter, ISO-KF to PVC Hose						in./(mm)
 <ul style="list-style-type: none"> Stainless Steel Type 304 Recommend the use of hose clamps 	Flange Size (ISO)	Hose Size	A	B	C	Part Number
	NW 10	1/2"	0.50 (13)	1.26 (32)	0.79 (20)	100316400
	NW 16	1/2"	0.50 (13)	1.26 (32)	0.79 (20)	100316411
	NW 16	3/4"	0.75 (19)	1.26 (32)	0.79 (20)	100316401
	NW 25	1"	1.00 (25)	1.50 (38)	1.02 (26)	100316403
	NW 40	1 1/2"	1.50 (38)	1.97 (50)	1.50 (38)	100316405
	NW 50	2"	2.00 (51)	2.17 (55)	1.61 (41)	100316406



Adapter, ISO-KF to Compression Fitting

in./(mm)

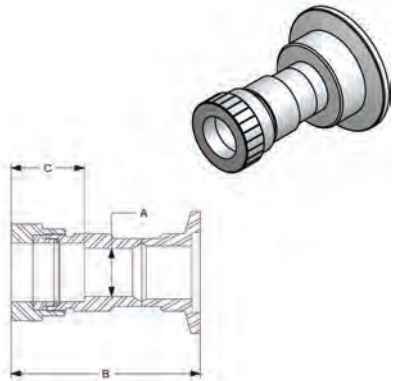
	Flange Size (ISO)	For Tubing OD	A	B	C	Part Number
	<ul style="list-style-type: none"> Stainless Steel Viton O-Ring Compression fitting tightened by hand Compression connect for tube insertion 	NW 10	1/2"	0.41 (10)	2.1 (53)	.80 (20)
	NW 16	1/4"	0.19 (5)	1.4 (36)	.62 (16)	100316911
	NW 16	1/2"	0.41 (10)	2.4 (61)	.80 (20)	100316921
	NW 16	3/4"	0.62 (16)	2.4 (61)	.94 (24)	100316931
	NW 25	1/2"	0.41 (10)	2.4 (61)	.80 (20)	100316903
	NW 25	3/4"	0.62 (16)	2.5 (64)	.94 (24)	100316913
	NW 25	1"	0.88 (22)	2.4 (61)	.94 (24)	100316923
	NW 40	1/2"	0.41 (10)	2.6 (66)	.80 (20)	100316905
	NW 40	3/4"	0.62 (16)	2.8 (71)	.94 (24)	100316915
	NW 40	1"	0.88 (22)	2.8 (71)	.94 (24)	100316925
	NW 40	1 1/8"	1.14 (29)	2.9 (74)	.94 (24)	100316945
	NW 40	1 1/2"	1.25 (32)	2.9 (74)	.94 (24)	100316935
	NW 50	3/4"	0.62 (16)	2.8 (71)	.94 (24)	100316926
	NW 50	1"	0.88 (22)	2.8 (71)	.94 (24)	100316936
	NW 50	1 1/8"	1.14 (29)	2.9 (74)	.94 (24)	100316946
	NW 50	1 1/2"	1.25 (32)	3.0 (76)	.94 (24)	100316906
	NW 50	2"	2.01 (51)	3.4 (87)	2.5 (63)	100316916

ISO-KF Viewing Port

in./(mm)

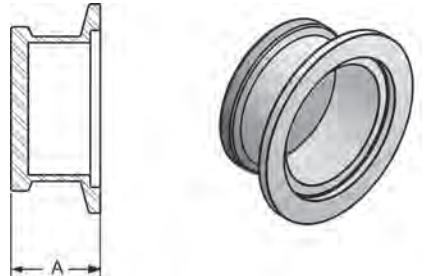
	Flange Size (ISO)	A	Part Number
	<ul style="list-style-type: none"> Stainless Steel Flange Max. Temperature 150°C Optical quality borosilicate glass 	NW 40	0.93 (24)
	NW 50	1.25 (32)	100319006

ISO-KF Elbow 90° Smooth Radius

in./(mm)

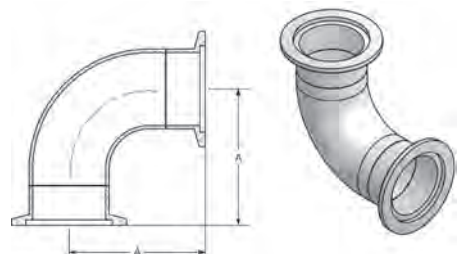
	Flange Size (ISO)	A	Part Number
	<ul style="list-style-type: none"> Stainless Steel Type 304 Same Size Flanges Both Ports Standard Modulus 	NW 16	1.57 (40)
	NW 25	1.97 (50)	100314403
	NW 40	2.56 (65)	100314505
	NW 50	2.76 (70)	100314506

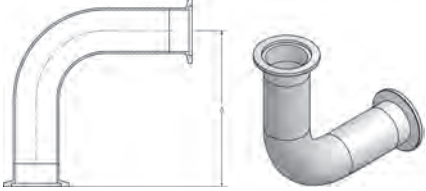

Ordering information

ISO-KF Elbow 90° Smooth, Long Radius			in./ (mm)
 <ul style="list-style-type: none"> Stainless Steel Type 304 Same Size Flanges both Ports Twice Standard Modulus 	Flange Size (ISO)	A	Part Number
	NW 40 NW 50	5.12 (130) 5.51 (140)	100314415 100314416

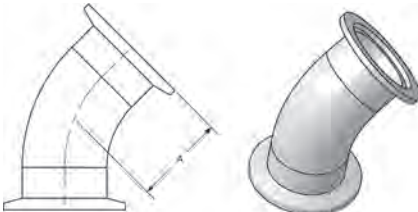
ISO-KF Elbow 45° Smooth Radius			in./ (mm)
 <ul style="list-style-type: none"> Stainless Steel Type 304 Same Size Flanges Both Ports 	Flange Size (ISO)	A	Part Number
	NW 16 NW 25 NW 40 NW 50	0.91 (23) 1.12 (28) 1.68 (43) 1.99 (51)	100318701 100318703 100318705 100318706

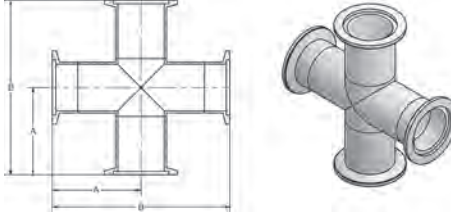
ISO-KF Cross			in./ (mm)	
 <ul style="list-style-type: none"> Stainless Steel Type 304 Same Size Flanges all Ports Standard Modulus 	Flange Size (ISO)	A	B	Part Number
	NW 16 NW 25 NW 40 NW 50	1.57 (40) 1.97 (50) 2.56 (65) 2.76 (70)	3.15 (80) 3.94 (100) 5.12 (130) 5.51 (140)	100314801 100314803 100314805 100314806



ISO-KF Tee

in./(mm)

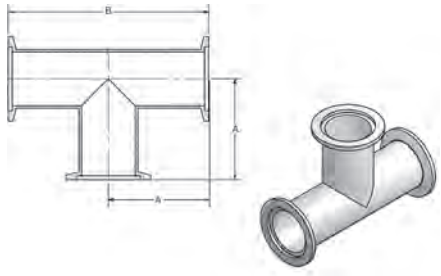

- Stainless Steel Type 304
- Same Size Flanges all Ports
- Standard Modulus

Flange Size (ISO)	A	B	Part Number
NW 16	1.57 (40)	3.15 (80)	100314601
NW 25	1.97 (50)	3.94 (100)	100314603
NW 40	2.56 (65)	5.12 (130)	100314605
NW 50	2.76 (70)	5.51 (140)	100314606

ISO-KF Tee, Reducing

in./(mm)

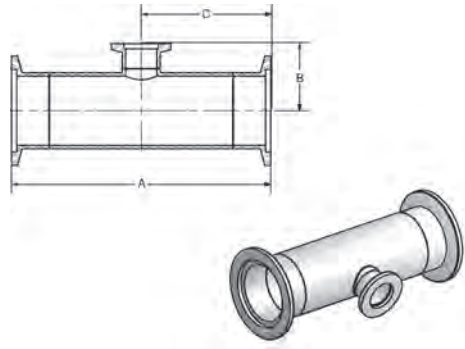

- Stainless Steel Type 304
- Same Size Flanges Thru Ports

Flange Size (ISO)	Flange Size (ISO) Tee	A	B	C	Part Number
NW 25	NW 16	3.94 (100)	1.08 (27)	1.97 (50)	100318403
NW 40	NW 16	5.12 (130)	1.32 (34)	2.56 (65)	100318405
NW 50	NW 16	5.51 (140)	1.58 (40)	2.76 (70)	100318406
NW 40	NW 25	4.80 (122)	2.40 (61)	2.40 (61)	100319816
NW 50	NW 25	6.29 (160)	2.65 (67)	3.15 (80)	100319815
NW 50	NW 40	6.29 (160)	2.65 (67)	3.15 (80)	100319814

ISO-KF Straight Section

in./(mm)

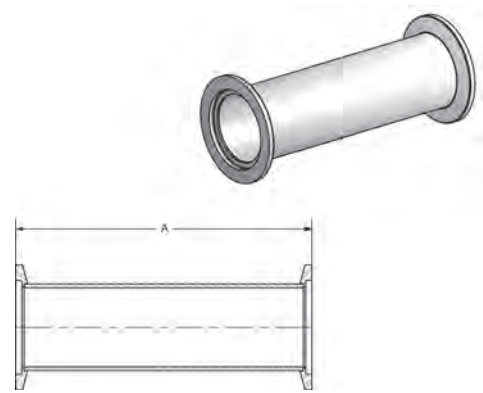

- Stainless Steel Type 304
- Special lengths to order

Flange Size (ISO)	A	Part Number
NW 16	3.15 (80)	100315101
NW 16	12.60 (320)	100315111
NW 25	3.94 (100)	100315103
NW 25	12.60 (320)	100315113
NW 40	5.12 (130)	100315105
NW 40	12.60 (320)	100315115
NW 50	5.51 (140)	100315106
NW 50	12.60 (320)	100315116

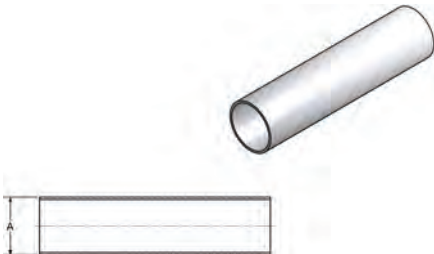

Ordering information

Tubing				in./(mm)
 <ul style="list-style-type: none"> • Tube ends deburred • Stainless Steel • Price per 10 foot length of tube 	Flange Size (ISO)	A	Tube Wall	Part Number
	NW 10	0.50 (13)	0.065 (1.7)	100314300
	NW 16	0.75 (19)	0.065 (1.7)	100314301
	NW 25	1.00 (25)	0.065 (1.7)	100314303
	NW 40	1.50 (38)	0.065 (1.7)	100314305
	NW 50	2.00 (51)	0.065 (1.7)	100314306
	NW 80	3.00 (76)	0.065 (1.7)	100764508
	NW 100	4.00 (102)	0.065 (1.7)	100764510
	NW 100	4.00 (102)	0.083 (2.1)	100764511

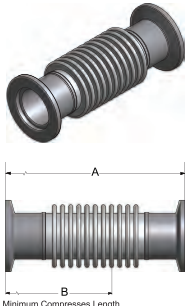
ISO-KF Bellows Section							in./(mm)
 <ul style="list-style-type: none"> • Stainless Steel Type 321 	Flange Size (ISO)	Static Bend Radius	Hose Wall	A	B	Spring Rate	Part Number
	NW 16	1 1/8"	.006 (0.15)	3.94 (100)	3.07 (78)	56 lb/in	100314911
	NW 25	1 3/8"	.006 (0.15)	3.94 (100)	3.07 (78)	44 lb/in	100314913
	NW 40	2 1/2"	.006 (0.15)	3.94 (100)	2.93 (74)	32 lb/in	100314915
	NW 50	3 1/4"	.006 (0.15)	3.94 (100)	3.11 (79)	32 lb/in	100314916

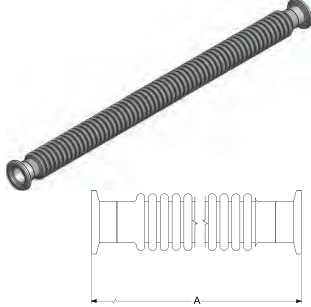
ISO-KF Thick Wall Metal Hose							in./(mm)
 <ul style="list-style-type: none"> • Stainless Steel • Unsheathed • Buttwelded • Special Lengths to Order • Thick wall hose static bend radius is to point of permanent deformation 	Flange Size (ISO)	Static Bend Radius	Hose Wall	A	Spring Rate	Part Number	
	NW 16	2 1/8"	.012 (0.30)	9.84 (250)	256 lb/in	100315901	
	NW 16	2 1/8"	.012 (0.30)	19.69 (500)	128 lb/in	100316001	
	NW 16	2 1/8"	.012 (0.30)	39.40 (1000)	64 lb/in	100316111	
	NW 25	2 7/8"	.012 (0.30)	9.84 (250)	224 lb/in	100315903	
	NW 25	2 7/8"	.012 (0.30)	19.69 (500)	112 lb/in	100316003	
	NW 25	2 7/8"	.012 (0.30)	39.40 (1000)	56 lb/in	100316113	
	NW 40	3 1/2"	.012 (0.30)	9.84 (250)	220 lb/in	100315905	
	NW 40	3 1/2"	.012 (0.30)	19.69 (500)	110 lb/in	100316005	
	NW 40	3 1/2"	.012 (0.30)	39.40 (1000)	55 lb/in	100316115	
	NW 50	5 1/4"	.012 (0.30)	9.84 (250)	220 lb/in	100315906	
	NW 50	5 1/4"	.012 (0.30)	19.69 (500)	110 lb/in	100316006	
NW 50	5 1/4"	.012 (0.30)	39.40 (1000)	55 lb/in	100316116		



ISO-KF Thin Wall Metal Hose

in./(mm)

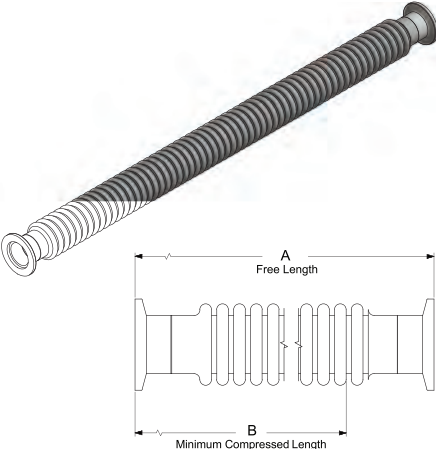
	Flange Size (ISO)	Static Bend Radius	Hose Wall	A	B	Spring Rate	Part Number
	<ul style="list-style-type: none"> Stainless Steel Unsheathed Buttwelded Special Lengths to Order 	NW 16	1 5/8"	.006 (0.15)	9.84 (250)	6.41 (163)	27 lb/in
	NW 16	1 5/8"	.006 (0.15)	12.02 (305)	7.82 (199)	21 lb/in	100319805
	NW 16	1 5/8"	.006 (0.15)	19.69 (500)	12.30 (313)	12 lb/in	100317421
	NW 16	1 5/8"	.006 (0.15)	24.09 (612)	18.12 (460)	9 lb/in	100319808
	NW 16	1 5/8"	.006 (0.15)	39.40 (1000)	24.10 (613)	5.8 lb/in	100317441
	NW 25	1 3/8"	.006 (0.15)	9.84 (250)	6.41 (163)	16 lb/in	100317413
	NW 25	1 3/8"	.006 (0.15)	11.99 (305)	7.82 (199)	14 lb/in	100319806
	NW 25	1 3/8"	.006 (0.15)	19.69 (500)	12.30 (313)	7.3 lb/in	100317423
	NW 25	1 3/8"	.006 (0.15)	24.00 (610)	18.12 (460)	6.5 lb/in	100319809
	NW 25	1 3/8"	.006 (0.15)	39.40 (1000)	24.10 (613)	3.4 lb/in	100317443
	NW 40	2 1/2"	.006 (0.15)	9.84 (250)	6.23 (158)	8.6 lb/in	100317415
	NW 40	2 1/2"	.006 (0.15)	12.12 (308)	7.88 (200)	7 lb/in	100319807
	NW 40	2 1/2"	.006 (0.15)	19.69 (500)	11.70 (297)	3.9 lb/in	100317425
	NW 40	2 1/2"	.006 (0.15)	24.05 (611)	18.12 (460)	3 lb/in	100319810
	NW 40	2 1/2"	.006 (0.15)	39.40 (1000)	22.50 (571)	1.9 lb/in	100317445
	NW 50	3 1/4"	.006 (0.15)	9.84 (250)	7.05 (179)	13 lb/in	100317416
	NW 50	3 1/4"	.006 (0.15)	11.93 (303)	8.64 (219)	12 lb/in	100319817
	NW 50	3 1/4"	.006 (0.15)	19.69 (500)	13.50 (342)	5.9 lb/in	100317426
	NW 50	3 1/4"	.006 (0.15)	24.08 (612)	18.12 (460)	5 lb/in	100319811
	NW 50	3 1/4"	.006 (0.15)	39.40 (1000)	26.30 (667)	2.9 lb/in	100317446

ISO-KF Braided Metal Hose

in./(mm)

	Flange Size (ISO)	Static Bend Radius	A	Part Number
	<ul style="list-style-type: none"> Ideal for rough pumping lines Stainless Steel Flexible, yet resistant to contraction 	NW 16	2 1/2"	10.23 (259)
	NW 16	2 1/2"	20.23 (514)	100313301
	NW 16	2 1/2"	40.23 (1022)	100313401
	NW 25	3"	10.27 (261)	100313203
	NW 25	3"	20.27 (515)	100313303
	NW 25	3"	40.27 (1023)	100313403
	NW 40	5"	10.28 (261)	100313205
	NW 40	5"	20.28 (515)	100313305
	NW 40	5"	40.28 (1023)	100313405
	NW 50	6"	10.53 (268)	100313206
	NW 50	6"	20.53 (522)	100313306
	NW 50	6"	40.53 (1030)	100313406



Ordering information

PVC Hose		in./(mm)	
 <ul style="list-style-type: none"> • Good for exhaust lines • Wire molded in tube wall for reinforcement • Larger OD PVC has limited flexibility in short lengths 	Flange Size (ISO)	A	Part Number
	NW 10	0.50 (13)	100317500-100
	NW 16	0.75 (19)	100317501-100
	NW 25	1.00 (25)	100317503-100
	NW 40	1.50 (38)	100317505-50
	NW 50	2.00 (51)	100317506-50

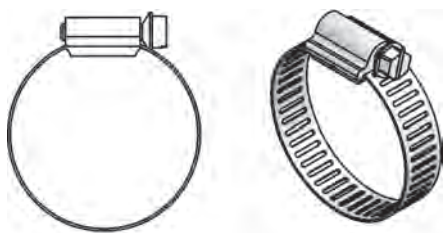
PVC Hose Clamps		in./(mm)	
	Flange Size (ISO)	A	Part Number
	NW 10	1/2"	100000797
	NW 16	3/4"	100000935
	NW 25	1"	100000936
	NW 40	1 1/2"	100000937
	NW 50	2"	100000938

Flange Protector Caps		in./(mm)	
<ul style="list-style-type: none"> • Protects Flange Faces • Plastic 	Flange Size (ISO)	Part Number	
	NW 16	100310001	
	NW 25	100310003	
	NW 40	100310005	
	NW 50	100310006	



10000797	PVC Hose Clamp, NW 10, 1/2"	100311801	Adapter, Hose , NW 16 to 5/8" or 3/4", Aluminum
10000935	PVC Hose Clamp, NW 16, 3/4"	100311803	Adapter, Hose , NW 25 to 3/4" or 7/8", Aluminum
10000936	PVC Hose Clamp, NW 25 1"	100311805	Adapter, Hose , NW 40 to 1 1/2" or 1 5/8", Aluminum
10000937	PVC Hose Clamp, NW 40 1 1/2"	100311806	Adapter, Hose , NW 50 to 1 1/2" or 1 5/8", Aluminum
10000938	PVC Hose Clamp, NW 50 2"	100311811	Adapter, Hose , NW 16 to 1/2" or 5/8", Aluminum
100001380	Seal, ASA O-ring, 2-231, 1 1/2", Viton	100312000	Adapter Pipe, NW 10 to 1/8" NPT, female, Aluminum
100006098	Seal, ASA O-ring, 2-237, 2", Viton	100312001	Adapter Pipe, NW 16 to 1/8" NPT, female, Aluminum
100006099	Seal, ASA O-ring, 2-247, 3", Viton	100312003	Adapter Pipe, NW 25 to 1/8" NPT, female, Aluminum
100310001	Flange Protector Caps, NW 16, Plastic	100312005	Adapter Pipe, NW 40 to 1/8" NPT, female, Aluminum
100310003	Flange Protector Caps, NW 25, Plastic	100312006	Adapter Pipe, NW 50 to 1/8" NPT, female, Aluminum
100310005	Flange Protector Caps, NW 40, Plastic	100312100	Adapter Pipe, NW 10 to 1/8" NPT, female, SS
100310006	Flange Protector Caps, NW 50, Plastic	100312101	Adapter Pipe, NW 16 to 1/8" NPT, female, SS
100310101	Flange, Short Weld Stub, NW 16, Aluminum	100312103	Adapter Pipe, NW 25 to 1/8" NPT, female, SS
100310103	Flange, Short Weld Stub, NW 25, Aluminum	100312105	Adapter Pipe, NW 40 to 1/8" NPT, female, SS
100310105	Flange, Short Weld Stub, NW 40, Aluminum	100312106	Adapter Pipe, NW 50 to 1/8" NPT, female, SS
100310106	Flange, Short Weld Stub, NW 50, Aluminum	100312200	Adapter Pipe, NW 10 to 1/4" NPT-F, Aluminum
100310111	Flange, Short Weld Stub, NW 16, Aluminum	100312201	Adapter Pipe, NW 16 to 1/4" NPT-F, Aluminum
100310201	Flange, Long Weld Stub, NW 16, Aluminum	100312203	Adapter Pipe, NW 25 to 1/4" NPT-F, Aluminum
100310203	Flange, Long Weld Stub, NW 25, Aluminum	100312205	Adapter Pipe, NW 40 to 1/4" NPT-F, Aluminum
100310205	Flange, Long Weld Stub, NW 40, Aluminum	100312206	Adapter Pipe, NW 50 to 1/4" NPT-F, Aluminum
100310206	Flange, Long Weld Stub, NW 50, Aluminum	100312300	Adapter Pipe, NW 10 to 1/4" NPT-F, SS
100310211	Flange, Long Weld Stub, NW 16, Aluminum	100312301	Adapter Pipe, NW 16 to 1/4" NPT-F, SS
100310300	Flange, Short Weld Stub, NW 10, 304 SS	100312303	Adapter Pipe, NW 25 to 1/4" NPT-F, SS
100310301	Flange, Short Weld Stub, NW 16, 304 SS	100312305	Adapter Pipe, NW 40 to 1/4" NPT-F, SS
100310303	Flange, Short Weld Stub, NW 25, 304 SS	100312306	Adapter Pipe, NW 50 to 1/4" NPT-F, SS
100310305	Flange, Short Weld Stub, NW 40, 304 SS	100312500	Centering Ring Assy, NW 10, Alum./Buna-N O-ring
100310306	Flange, Short Weld Stub, NW 50, 304 SS	100312501	Centering Ring Assy, NW 16, Alum./Buna-N O-ring
100310311	Flange, Short Weld Stub, NW 16, 304 SS	100312503	Centering Ring Assy, NW 25, Alum./Buna-N O-ring
100311100	Flange, Unbored, NW 10, Aluminum	100312505	Centering Ring Assy, NW 40, Alum./Buna-N O-ring
100311101	Flange, Unbored, NW 16, Aluminum	100312506	Centering Ring Assy, NW 50, Alum./Buna-N O-ring
100311103	Flange, Unbored, NW 25, Aluminum	100312600	Centering Ring Assy, NW 10, Alum./Viton O-ring
100311105	Flange, Unbored, NW 40, Aluminum	100312601	Centering Ring Assy, NW 16, Alum./Viton O-ring
100311106	Flange, Unbored, NW 50, Aluminum	100312603	Centering Ring Assy, NW 25, Alum./Viton O-ring
100311300	Flange, Unbored, NW 10, 304 Stainless Steel	100312605	Centering Ring Assy, NW 40, Alum./Viton O-ring
100311301	Flange, Unbored, NW 16, 304 Stainless Steel	100312606	Centering Ring Assy, NW 50, Alum./Viton O-ring
100311303	Flange, Unbored, NW 25, 304 Stainless Steel	100312700	Centering Ring Assy, NW 10, SS/Viton O-ring
100311305	Flange, Unbored, NW 40, 304 Stainless Steel	100312701	Centering Ring Assy, NW 16, SS/Viton O-ring
100311306	Flange, Unbored, NW 50, 304 Stainless Steel	100312703	Centering Ring Assy, NW 25, SS/Viton O-ring
100311600	Flange, Blank-Off, NW 10, Aluminum	100312705	Centering Ring Assy, NW 40, SS/Viton O-ring
100311601	Flange, Blank-Off, NW 16, Aluminum	100312706	Centering Ring Assy, NW 50, SS/Viton O-ring
100311603	Flange, Blank-Off, NW 25, Aluminum	100312800	Centering Ring Assy, NW 10, SS/Buna-N O-ring
100311605	Flange, Blank-Off, NW 40, Aluminum	100312801	Centering Ring Assy, NW 16, SS/Buna-N O-ring
100311606	Flange, Blank-Off, NW 50, Aluminum	100312803	Centering Ring Assy, NW 25, SS/Buna-N O-ring
100311700	Flange, Blank-Off, NW 10, 304 Stainless Steel	100312805	Centering Ring Assy, NW 40, SS/Buna-N O-ring
100311701	Flange, Blank-Off, NW 16, 304 Stainless Steel	100312806	Centering Ring Assy, NW 50, SS/Buna-N O-ring
100311703	Flange, Blank-Off, NW 25, 304 Stainless Steel	100312901	Wing Nut Clamp, NW 16, fits 16/10, Aluminum
100311705	Flange, Blank-Off, NW 40, 304 Stainless Steel	100312903	Wing Nut Clamp, NW 25, fits 25/20, Aluminum
100311706	Flange, Blank-Off, NW 50, 304 Stainless Steel	100312905	Wing Nut Clamp, NW 40, fits 40/32, Aluminum
		100312906	Wing Nut Clamp, NW 50, fits 50, Aluminum



Numerical Listing

100313201	Braided Metal Hose, 10", NW 16, Stainless Steel	100314801	Cross, NW 16, 304 Stainless Steel
100313203	Braided Metal Hose, 10", NW 25, Stainless Steel	100314803	Cross, NW 25, 304 Stainless Steel
100313205	Braided Metal Hose, 10", NW 40, Stainless Steel	100314805	Cross, NW 40, 304 Stainless Steel
100313206	Braided Metal Hose, 10", NW 50, Stainless Steel	100314806	Cross, NW 50, 304 Stainless Steel
100313301	Braided Metal Hose, 20", NW 16, Stainless Steel		
100313303	Braided Metal Hose, 20", NW 25, Stainless Steel	100314911	Bellows, NW 16, Stainless Steel
100313305	Braided Metal Hose, 20", NW 40, Stainless Steel	100314913	Bellows, NW 25, Stainless Steel
100313306	Braided Metal Hose, 20", NW 50, Stainless Steel	100314915	Bellows, NW 40, Stainless Steel
100313401	Braided Metal Hose, 40", NW 16, Stainless Steel	100314916	Bellows, NW 50, Stainless Steel
100313403	Braided Metal Hose, 40", NW 25, Stainless Steel		
100313405	Braided Metal Hose, 40", NW 40, Stainless Steel	100315101	Straight Section, NW 16, 304 Stainless Steel
100313406	Braided Metal Hose, 40", NW 50, Stainless Steel	100315103	Straight Section, NW 25, 304 Stainless Steel
		100315105	Straight Section, NW 40, 304 Stainless Steel
100313511	Conical Reducer, NW 16 to NW 25, Aluminum	100315106	Straight Section, NW 50, 304 Stainless Steel
100313512	Conical Reducer, NW 16 to NW 40, Aluminum	100315111	Straight Section, NW 16, 304 Stainless Steel
100313513	Conical Reducer, NW 16 to NW 50, Aluminum	100315113	Straight Section, NW 25, 304 Stainless Steel
100313514	Conical Reducer, NW 25 to NW 40, Aluminum	100315115	Straight Section, NW 40, 304 Stainless Steel
100313515	Conical Reducer, NW 25 to NW 50, Aluminum	100315116	Straight Section, NW 50, 304 Stainless Steel
100313516	Conical Reducer, NW 40 to NW 50, Aluminum		
		100315601	Adapter, ISO-KF to CF, NW 16 to 1-1/3" CF, SS
100313711	Conical Reducer, NW 16 to NW 25, 304 SS	100315603	Adapter, ISO-KF to CF, NW 25 to 2-3/4" CF, SS
100313712	Conical Reducer, NW 16 to NW 40, 304 SS	100315605	Adapter, ISO-KF to CF, NW 40 to 2-3/4" CF, SS
100313713	Conical Reducer, NW 16 to NW 50, 304 SS	100315606	Adapter, ISO-KF to CF, NW 50 to 4-1/2" CF, SS
100313714	Conical Reducer, NW 25 to NW 40, 304 SS	100315611	Adapter, ISO-KF to CF, NW 16 to 2-3/4" CF, SS
100313715	Conical Reducer, NW 25 to NW 50, 304 SS		
100313716	Conical Reducer, NW 40 to NW 50, 304 SS	100315700	Flange, Long Weld Stub, NW 10, 304 SS
		100315701	Flange, Long Weld Stub, NW 16, 304 SS
100313900	O-Ring, standard size 2-312, NW 10, Buna-N	100315703	Flange, Long Weld Stub, NW 25, 304 SS
100313901	O-Ring, standard size 2-314, NW 16, Buna-N	100315705	Flange, Long Weld Stub, NW 40, 304 SS
100313903	O-Ring, standard size 2-320, NW 25, Buna-N	100315706	Flange, Long Weld Stub, NW 50, 304 SS
100313905	O-Ring, standard size 2-326, NW 40, Buna-N	100315711	Flange, Long Weld Stub, NW 16, 304 SS
100313906	O-Ring, standard size 2-330, NW 50, Buna-N		
		100315801	Seal Assembly, NW 16 to NW 10, Aluminum/Buna
100314000	O-Ring, standard size 2-312, NW 10, Viton	100315803	Seal Assembly, NW 25 to NW 20, Aluminum/Buna
100314001	O-Ring, standard size 2-314, NW 16, Viton	100315805	Seal Assembly, NW 40 to NW 32, Aluminum/Buna
100314003	O-Ring, standard size 2-320, NW 25, Viton		
100314005	O-Ring, standard size 2-326, NW 40, Viton	100315811	Seal Assembly, NW 16 to NW 10, Aluminum/Viton O-ring
100314006	O-Ring, standard size 2-330, NW 50, Viton	100315813	Seal Assembly, NW 25 to NW 20, Aluminum/Viton
		100315815	Seal Assembly, NW 40 to NW 32, Aluminum/Viton
100314300	Tube (price per 10 foot), NW 10, 0.50" O.D., SS		
100314301	Tube (price per 10 foot), NW 16, 0.75" O.D., SS	100315821	Seal Assembly, NW 16 to NW 10, SS/Viton
100314303	Tube (price per 10 foot), NW 25, 1.00" O.D., SS	100315823	Seal Assembly, NW 25 to NW 20, SS/Viton
100314305	Tube (price per 10 foot), NW 40, 1.50" O.D., SS	100315825	Seal Assembly, NW 40 to NW 32, SS/Viton
100314306	Tube (price per 10 foot), NW 50, 2.00" O.D., SS		
		100315901	Metal Hose, Thick Wall, 10", NW 16, SS
100314401	90° Elbow, Smooth Radius, NW 16, 304 SS	100315903	Metal Hose, Thick Wall, 10", NW 25, SS
100314403	90° Elbow, Smooth Radius, NW 25, 304 SS	100315905	Metal Hose, Thick Wall, 10", NW 40, SS
100314415	90° Elbow, Long Radius, NW 40, 304 SS	100315906	Metal Hose, Thick Wall, 10", NW 50, SS
100314416	90° Elbow, Long Radius, NW 50, 304 SS	100316001	Metal Hose, Thick Wall, 20", NW 16, SS
100314505	90° Elbow, Smooth Radius, NW 40, 304 SS	100316003	Metal Hose, Thick Wall, 20", NW 25, SS
100314506	90° Elbow, Smooth Radius, NW 50, 304 SS	100316005	Metal Hose, Thick Wall, 20", NW 40, SS
		100316006	Metal Hose, Thick Wall, 20", NW 50, SS
100314601	Tee, NW 16, 304 Stainless Steel	100316111	Metal Hose, Thick Wall, 40", NW 16, SS
100314603	Tee, NW 25, 304 Stainless Steel	100316113	Metal Hose, Thick Wall, 40", NW 25, SS
100314605	Tee, NW 40, 304 Stainless Steel	100316115	Metal Hose, Thick Wall, 40", NW 40, SS
100314606	Tee, NW 50, 304 Stainless Steel	100316116	Metal Hose, Thick Wall, 40", NW 50, SS



100316301	Overpressure Ring, NW 16, 304 SS/Silicone	100317300	Centering Ring Assy, NW 10, SS/Silicone O-ring
100316303	Overpressure Ring, NW 25, 304 SS/Silicone	100317301	Centering Ring Assy, NW 16, SS/Silicone O-ring
100316305	Overpressure Ring, NW 40, 304 SS/Silicone	100317303	Centering Ring Assy, NW 25, SS/Silicone O-ring
100316306	Overpressure Ring, NW 50, 304 SS/Silicone	100317305	Centering Ring Assy, NW 40, SS/Silicone O-ring
		100317306	Centering Ring Assy, NW 50, SS/Silicone O-ring
100316400	Adapter, NW 10 to 1/2" PVC Tubing, 304 SS	100317310	O-Ring, standard size 2-312, NW 10, Silicone 604
100316401	Adapter, NW 16 to 3/4" PVC Tubing, 304 SS	100317311	O-Ring, standard size 2-314, NW 16, Silicone 604
100316403	Adapter, NW 25 to 1" PVC Tubing, 304 SS	100317313	O-Ring, standard size 2-320, NW 25, Silicone 604
100316405	Adapter, NW 40 to 1 1/2" PVC Tubing, 304 SS	100317315	O-Ring, standard size 2-326, NW 40, Silicone 604
100316406	Adapter, NW 50 to 2" PVC Tubing, 304 SS	100317316	O-Ring, standard size 2-330, NW 50, Silicone 604
100316411	Adapter, NW 16 to 1/2" PVC Tubing, 304 SS		
100316705	Adapter, NW 40 to 2" ASA, w/out groove, 304 SS	100317411	Metal Hose, Thin Wall, 10", NW 16, SS
100316706	Adapter, NW 50 to 2" ASA, w/out groove, 304 SS	100317413	Metal Hose, Thin Wall, 10", NW 25, SS
100316715	Adapter, NW 40 to 3" ASA, w/out groove, 304 SS	100317415	Metal Hose, Thin Wall, 10", NW 40, SS
100316716	Adapter, NW 50 to 3" ASA, w/out groove, 304 SS	100317416	Metal Hose, Thin Wall, 10", NW 50, SS
		100317421	Metal Hose, Thin Wall, 20", NW 16, SS
100316725	Adapter, NW 40 to 2" ASA with groove, 304 SS	100317423	Metal Hose, Thin Wall, 20", NW 25, SS
100316726	Adapter, NW 50 to 2" ASA with groove, 304 SS	100317425	Metal Hose, Thin Wall, 20", NW 40, SS
100316735	Adapter, NW 40 to 3" ASA with groove, 304 SS	100317426	Metal Hose, Thin Wall, 20", NW 50, SS
100316736	Adapter, NW 50 to 3" ASA with groove, 304 SS	100317441	Metal Hose, Thin Wall, 40", NW 16, SS
		100317443	Metal Hose, Thin Wall, 40", NW 25, SS
100316755	Adapter, NW 40 to 1.5" ASA, w/out groove, 304 SS	100317445	Metal Hose, Thin Wall, 40", NW 40, SS
100316756	Adapter, NW 50 to 1.5" ASA, w/out groove, 304 SS	100317446	Metal Hose, Thin Wall, 40", NW 50, SS
100316775	Adapter, NW 40 to 1.5" ASA with groove, 304 SS	100317500-100	PVC Hose (price per 100 foot), NW 10, PVC
100316776	Adapter, NW 50 to 1.5" ASA with groove, 304 SS	100317501-100	PVC Hose (price per 100 foot), NW 16, PVC
		100317503-100	PVC Hose (price per 100 foot), NW 25, PVC
100316801	Adapter, NW 16 to 1/8" NPT-M, 304 SS	100317505-50	PVC Hose (price per 50 foot), NW 40, PVC
100316803	Adapter, NW 25 to 1/8" NPT-M, 304 SS	100317506-50	PVC Hose (price per 50 foot), NW 50, PVC
100316805	Adapter, NW 40 to 1/4" NPT-M, 304 SS		
100316806	Adapter, NW 50 to 1/4" NPT-M, 304 SS	100318301	Weld Socket Flange, NW 16, 304 SS
100316811	Adapter, NW 16 to 1/4" NPT-M, 304 SS	100318303	Weld Socket Flange, NW 25, 304 SS
100316813	Adapter, NW 25 to 1/4" NPT-M, 304 SS	100318305	Weld Socket Flange, NW 40, 304 SS
100316815	Adapter, NW 40 to 1/2" NPT-M, 304 SS	100318306	Weld Socket Flange, NW 50, 304 SS
100316816	Adapter, NW 50 to 1/2" NPT-M, 304 SS	100318311	Weld Socket Flange, NW 16, 304 SS
100316823	Adapter, NW 25 to 1/2" NPT-M, 304 SS	100318321	Weld Socket Flange, NW 16, 304 SS
100316825	Adapter, NW 40 to 3/4" NPT-M, 304 SS		
100316826	Adapter, NW 50 to 3/4" NPT-M, 304 SS	100318403	Reducing Tee, NW 25 to NW 16, 304 SS
100316833	Adapter, NW 25 to 3/4" NPT-M, 304 SS	100318405	Reducing Tee, NW 40 to NW 16, 304 SS
100316835	Adapter, NW 40 to 1" NPT-M, 304 SS	100318406	Reducing Tee, NW 50 to NW 16, 304 SS
100316836	Adapter, NW 50 to 1" NPT-M, 304 SS		
100316844	Adapter, NW 40 to 1.25" NPT-M, 304 SS	100318601	Seal Assembly w/Screen, NW 16, SS/Viton O-ring
100316845	Adapter, NW 40 to 1.5" NPT-M, 304 SS	100318603	Seal Assembly w/Screen, NW 25, SS/Viton O-ring
100316846	Adapter, NW 50 to 2" NPT-M, 304 SS	100318605	Seal Assembly w/Screen, NW 40, SS/Viton O-ring
		100318606	Seal Assembly w/Screen, NW 50, SS/Viton O-ring
100316903	Adapter Tubing, NW 25 to 1/2", SS, Viton O-Ring		
100316905	Adapter Tubing, NW 40 to 1/2", SS, Viton O-Ring	100318701	45° Elbow, Smooth Radius, NW 16, 304 SS
100316906	Adapter Tubing, NW 50 to 1 1/2", SS, Viton O-Ring	100318703	45° Elbow, Smooth Radius, NW 25, 304 SS
100316910	Adapter Tubing, NW 10 to 1/2", SS, Viton O-Ring	100318705	45° Elbow, Smooth Radius, NW 40, 304 SS
100316911	Adapter Tubing, NW 16 to 1/4", SS, Viton O-Ring	100318706	45° Elbow, Smooth Radius, NW 50, 304 SS
100316913	Adapter Tubing, NW 25 to 3/4", SS, Viton O-Ring		
100316915	Adapter Tubing, NW 40 to 3/4", SS, Viton O-Ring	100318801	Toggle Clamp, NW 16, fits 16/10, Aluminum
100316916	Adapter Tubing, NW 50 to 2", SS, Viton O-Ring	100318803	Toggle Clamp, NW 25, fits 25/20, Aluminum
100316921	Adapter Tubing, NW 16 to 1/2", SS, Viton O-Ring	100318805	Toggle Clamp, NW 40, fits 40/32, Aluminum
100316923	Adapter Tubing, NW 25 to 1", SS, Viton O-Ring	100318806	Toggle Clamp, NW 50, fits 50, Aluminum
100316925	Adapter Tubing, NW 40 to 1", SS, Viton O-Ring		
100316926	Adapter Tubing, NW 50 to 3/4", SS, Viton O-Ring	100318801-L	Toggle Clamp w/ Lanyard, NW 16, 16/10, Aluminum
100316931	Adapter Tubing, NW 16 to 3/4", SS, Viton O-Ring	100318803-L	Toggle Clamp w/ Lanyard, NW 25, 25/20, Aluminum
100316935	Adapter Tubing, NW 40 to 1 1/2", SS, Viton O-Ring	100318805-L	Toggle Clamp w/ Lanyard, NW 40, 40/32, Aluminum
100316936	Adapter Tubing, NW 50 to 1", SS, Viton O-Ring	100318806-L	Toggle Clamp w/ Lanyard, NW 50, 50, Aluminum
100316945	Adapter Tubing, NW 40 to 1 1/8", SS, Viton O-Ring		
100316946	Adapter Tubing, NW 50 to 1 1/8", SS, Viton O-Ring		



Numerical Listing

100318901	Bulkhead Clamp, 6 Bolts, NW 16, Aluminum	100319731	Flange, Blank with Bore, NW 16, 304 SS
100318903	Bulkhead Clamp, 6 Bolts, NW 25, Aluminum	100319733	Flange, Blank with Bore, NW 25, 304 SS
100318905	Bulkhead Clamp, 6 Bolts, NW 40, Aluminum	100319735	Flange, Blank with Bore, NW 40, 304 SS
100318906	Bulkhead Clamp, 8 Bolts, NW 50, Aluminum	100319736	Flange, Blank with Bore, NW 50, 304 SS
100319005	Bonded Viewport, NW 40, SS, Borosilicate Glass	100319743	Flange, Blank with Bore, NW 25, 304 SS
100319006	Bonded Viewport, NW 50, SS, Borosilicate Glass	100319745	Flange, Blank with Bore, NW 40, 304 SS
100319111	Adapter, VCR-M, NW 16 to 4 VCR, SS	100319746	Flange, Blank with Bore, NW 50, 304 SS
100319113	Adapter, VCR-M, NW 25 to 4 VCR, SS	100319755	Flange, Blank with Bore, NW 40, 304 SS
100319115	Adapter, VCR-M, NW 40 to 4 VCR, SS	100319756	Flange, Blank with Bore, NW 50, 304 SS
100319116	Adapter, VCR-M, NW 50 to 4 VCR, SS	100319766	Flange, Blank with Bore, NW 50, 304 SS
100319121	Adapter, VCR-M, NW 16 to 8 VCR, SS	100319801	Flange, Blank with Bore, NW 80, 304 SS
100319123	Adapter, VCR-M, NW 25 to 8 VCR, SS	100319802	Flange, Blank-Off, NW 80, 304 SS
100319125	Adapter, VCR-M, NW 40 to 8 VCR, SS	100319803	Flange, Blank with Bore, NW 100, 304 SS
100319126	Adapter, VCR-M, NW 50 to 8 VCR, SS	100319804	Flange, Blank-Off, NW 100, 304 SS
100319133	Adapter, VCR-M, NW 25 to 12 VCR, SS	100319805	Metal Hose, Thin Wall, 12", NW 16, SS
100319135	Adapter, VCR-M, NW 40 to 12 VCR, SS	100319806	Metal Hose, Thin Wall, 12", NW 25, SS
100319136	Adapter, VCR-M, NW 50 to 12 VCR, SS	100319807	Metal Hose, Thin Wall, 12", NW 40, SS
100319211	Adapter, VCR-F, NW 16 to 4 VCR, SS	100319808	Metal Hose, Thin Wall, 24", NW 16, SS
100319213	Adapter, VCR-F, NW 25 to 4 VCR, SS	100319809	Metal Hose, Thin Wall, 24", NW 25, SS
100319215	Adapter, VCR-F, NW 40 to 4 VCR, SS	100319810	Metal Hose, Thin Wall, 24", NW 40, SS
100319216	Adapter, VCR-F, NW 50 to 4 VCR, SS	100319811	Metal Hose, Thin Wall, 24", NW 50, SS
100319221	Adapter, VCR-F, NW 16 to 8 VCR, SS	100319817	Metal Hose, Thin Wall, 12", NW 50, SS
100319223	Adapter, VCR-F, NW 25 to 8 VCR, SS	100319812	Adapter, NW 25 to 2 1/8" CF, 304 SS
100319225	Adapter, VCR-F, NW 40 to 8 VCR, SS	100319813	Adapter, NW 50 to 2 3/4" CF, 304 SS
100319226	Adapter, VCR-F, NW 50 to 8 VCR, SS	100319814	Reducing Tee, NW 50 to NW 40, 304 SS
100319233	Adapter, VCR-F, NW 25 to 12 VCR, SS	100319815	Reducing Tee, NW 50 to NW 25, 304 SS
100319235	Adapter, VCR-F, NW 40 to 12 VCR, SS	100319816	Reducing Tee, NW 40 to NW 25, 304 SS
100319236	Adapter, VCR-F, NW 50 to 12 VCR, SS	100760508	Seal Assembly, NW 80, SS/Viton O-ring
100319301	Adapter Tee, NW 16 to 1/8" NPT-F, Aluminum	100760510	Seal Assembly, NW 100, SS/Viton O-ring
100319303	Adapter Tee, NW 25 to 1/8" NPT-F, Aluminum	100760608	Seal Assembly, NW 80, Aluminum/Viton O-ring
100319305	Adapter Tee, NW 40 to 1/8" NPT-F, Aluminum	100760610	Seal Assembly, NW 100, Aluminum/Viton O-ring
100319306	Adapter Tee, NW 50 to 1/8" NPT-F, Aluminum	100760708	Seal Assembly, NW 80, Aluminum/Buna-N O-ring
100319401	Adapter Tee, NW 16 to 1/8" NPT-F, 304 SS	100760710	Seal Assembly, NW 100, Aluminum/Buna-N O-ring
100319403	Adapter Tee, NW 25 to 1/8" NPT-F, 304 SS	100761908	O-Ring, standard size 2-340, NW 80, Buna-N
100319405	Adapter Tee, NW 40 to 1/8" NPT-F, 304 SS	100761910	O-Ring, standard size 2-346, NW 100, Buna-N
100319406	Adapter Tee, NW 50 to 1/8" NPT-F, 304 SS	100762008	O-Ring, standard size 2-340, NW 80, Viton
100319501	Adapter Tee, NW 16 to 1/4" NPT-F, Aluminum	100762010	O-Ring, standard size 2-346, NW 100, Viton
100319503	Adapter Tee, NW 25 to 1/4" NPT-F, Aluminum	100762606	Step Adapter, NW 63 to NW 40, SS
100319505	Adapter Tee, NW 40 to 1/4" NPT-F, Aluminum	100762608	Step Adapter, NW 80 to NW 50, SS
100319506	Adapter Tee, NW 50 to 1/4" NPT-F, Aluminum	100762616	Step Adapter, NW 80 to NW 40, SS
100319601	Adapter Tee, NW 16 to 1/4" NPT-F, 304 SS	100762617	Step Adapter, NW 63 to NW 50, SS
100319603	Adapter Tee, NW 25 to 1/4" NPT-F, 304 SS	100762618	Step Adapter, NW 100 to NW 50, SS
100319605	Adapter Tee, NW 40 to 1/4" NPT-F, 304 SS	100762620	Step Adapter, NW 100 to NW 40, SS
100319606	Adapter Tee, NW 50 to 1/4" NPT-F, 304 SS	100764508	Tube (price per 10 foot), NW 80, 3.00" O.D., SS
100319700	Flange, Blank with Bore, NW 10, 304 SS	100764510	Tube (price per 10 foot), NW 100, 4.00" O.D., SS
100319701	Flange, Blank with Bore, NW 16, 304 SS	100764511	Tube (price per 10 foot), NW 100, 4.00" O.D., SS
100319703	Flange, Blank with Bore, NW 25, 304 SS	100765006	Conical Adapter, NW 63 to NW 40, SS
100319705	Flange, Blank with Bore, NW 40, 304 SS	100765008	Conical Adapter, NW 80 to NW 50, SS
100319706	Flange, Blank with Bore, NW 50, 304 SS	100765016	Conical Adapter, NW 80 to NW 40, SS
100319710	Flange, Blank with Bore, NW 10, 304 SS	100765017	Conical Adapter, NW 63 to NW 50, SS
100319711	Flange, Blank with Bore, NW 16, 304 SS	100765018	Conical Adapter, NW 100 to NW 50, SS
100319713	Flange, Blank with Bore, NW 25, 304 SS	100936523	Overpressure Seal Assy, NW 50, SS/Viton
100319715	Flange, Blank with Bore, NW 40, 304 SS	100936524	Overpressure Seal Assy, NW 40, SS/Viton
100319716	Flange, Blank with Bore, NW 50, 304 SS	100936525	Overpressure Seal Assy, NW 25, SS/Viton
100319720	Flange, Blank with Bore, NW 10, 304 SS	100993460	Chain Clamp, NW 80, Aluminum
100319721	Flange, Blank with Bore, NW 16, 304 SS	100994717	Chain Clamp, NW 100, Aluminum
100319723	Flange, Blank with Bore, NW 25, 304 SS		
100319725	Flange, Blank with Bore, NW 40, 304 SS		
100319726	Flange, Blank with Bore, NW 50, 304 SS		





Series 31 ISO-KF Components - 6/18
© 2008-2018 MKS Instruments, Inc.
All rights reserved.

**MKS Instruments, Inc.
Global Headquarters**

2 Tech Drive, Suite 201
Andover, MA 01810

Tel: 978.645.5500
Tel: 800.227.8766 (in USA)
Web: www.mksinst.com

**MKS Instruments, Inc.
Integrated Process Solutions**

5330 Sterling Drive
Boulder, CO 80301

Tel: 303.449.9861
Tel: 800.345.1967 (in USA)

MKS products provided subject to the US Export Regulations. Diversion or transfer contrary to US law is prohibited. Specifications are subject to change without notice. mksinst™ is a trademark of MKS Instruments, Inc., Viton® and Teflon® are registered trademarks of E.I. DuPont de Nemours & Co., Inc., VCR® is a registered trademark of Swagelok Marketing Co, Solon, OH.