

**MKS Baratron®
Type E27F
Absolute Pressure Etch Manometer**

Copyright © 2013 by MKS Instruments, Inc.

All rights reserved. No part of this work may be reproduced or transmitted in any form or by any means, electronic or mechanical, including photocopying and recording, or by any information storage or retrieval system, except as may be expressly permitted in writing by MKS Instruments, Inc.

Printed in the United States of America

Mksinst[™] is a trademark and Baratron[®] is a registered trademark of MKS Instruments, Inc., Andover, MA, USA.

Swagelok[®], VCO[®], and VCR[®] are registered trademarks of Swagelok Co., Solon, OH, USA.

Inconel[®] is a registered trademark of Inco Alloys international, Huntington, WV, USA.

Some Baratron[®] products may not be exported to many end user countries without both US and local government export licenses under ECCN 2B230.

Table of Contents

Pressure Transducer Safety Information	1
Symbols Used in This Instruction Manual.....	1
Symbols Found on the Unit	2
Safety Procedures and Precautions	3
Sicherheitshinweise für den Druckmeßumformer	5
In dieser Betriebsanleitung vorkommende Symbole	5
Erklärung der am Gerät angebrachten Symbole	6
Sicherheitsvorschriften und Vorsichtsmaßnahmen.....	7
Informations relatives à la sécurité pour le transducteur de pression	9
Symboles utilisés dans ce manuel d'utilisation	9
Symboles apparaissant sur l'unité	10
Mesures de sécurité et précautions	11
Medidas de seguridad del transductor de presión	13
Símbolos usados en este manual de instrucciones	13
Símbolos hallados en la unidad.....	14
Procedimientos y precauciones de seguridad.....	15
Chapter One: General Information	17
Introduction.....	17
How This Manual is Organized	18
Customer Support	18
Chapter Two: Installation	19
How To Unpack the Type E27F Manometer.....	19
Unpacking Checklist.....	19
Interface Cables	19
Generic Shielded Cable Guidelines	20
Product Location and Requirements.....	21
Ambient Operating Temperature	21
Power Requirements	21
Setup	22

Dimensions	22
Fittings	23
Mounting Instructions	23
Electrical Information	24
Grounding	24
Interface Connector.....	24
Startup.....	26
Warm Up Time	26
Chapter Three: Overview.....	27
General Information.....	27
Sensor.....	27
Signal Conditioner/Electronics	27
Instrument Components	28
Coarse Zero Switch.....	28
Optional Heater Status LEDs and Semiconductor Switches	28
Zero Potentiometer	28
Interface Connector.....	28
Labels.....	29
Top Panel Labels	29
Band Label.....	29
Serial Number Label	30
Chapter Four: Operation	31
How to Adjust the Zero.....	31
How To Adjust the Zero Potentiometer.....	31
How To Adjust the Coarse Zero Switch	32
Suggested Pressures for Reading and Control	33
Chapter Five: Maintenance and Troubleshooting.....	35
General Information.....	35
Maintenance.....	35
Zero Adjustment	35
Troubleshooting.....	36
Appendix A: Product Specifications.....	37

Electrical Specifications	37
Environmental Specifications	37
Performance Specifications	37
Physical Specifications	38
Optional Semiconductor Switch Specification	38
Appendix B: Model Code Explanation	39
Model Code.....	39
Index	42

List of Figures

Figure 1: Top View Dimensions	22
Figure 2: Side View Dimensions	22
Figure 3: Power, Signal, and Chassis Grounding Scheme Example.....	24
Figure 4: Top View of the E27F Manometer.....	28
Figure 5: Top Panel Label for Units Without Optional Heater Status LEDs.....	29
Figure 6: Top Panel Label for Units With Optional Heater Status LEDs.....	29
Figure 7: Band Label	29
Figure 8: Serial Number Label	30

List of Tables

Table 1: Definition of Symbols Found on the Unit	2
Tabelle 2: Bedeutung der am Gerät angebrachten Symbole	6
Tableau 3: Définition des symboles apparaissant sur l'unité	10
Tabla 4: Definición de los símbolos hallados en la unidad.....	14
Table 5: Interface Cables	20
Table 6: Interface Connector Pinout	25
Table 7: Highest Pressures Suggested for Proper Zero Adjustment	32
Table 8: Lowest Suggested Pressures for Reading and Control	33
Table 9: Troubleshooting Chart	36

Pressure Transducer Safety Information

Symbols Used in This Instruction Manual

Definitions of WARNING, CAUTION, and NOTE messages used throughout the manual.

Warning



The **WARNING** sign denotes a hazard to personnel. It calls attention to a procedure, practice, condition, or the like, which, if not correctly performed or adhered to, could result in injury to personnel.

Caution



The **CAUTION** sign denotes a hazard to equipment. It calls attention to an operating procedure, practice, or the like, which, if not correctly performed or adhered to, could result in damage to or destruction of all or part of the product.

Note























The **NOTE** sign denotes important information. It calls attention to a procedure, practice, condition, or the like, which is essential to highlight.

Symbols Found on the Unit

The following table describes symbols that may be found on the unit.

Table 1: Definition of Symbols Found on the Unit

  Off (Supply) IEC 417, No.5008	 Off (Supply) IEC 417, No.5008	  Ear (ground) IEC 417, No.5009	 Relative earth (ground) IEC 417, No.5019
  Fire IEC 417, No.5020	  Fire IEC 417, No.5020	  Fire IEC 417, No.5020	 Alternating current IEC 417, No.5032
 Both direct and alternating current IEC 417, No.5033-a	  Fire IEC 417, No.5020	 Three phase alternating current IEC 617-2 No.020206	
 Caution, refer to accompanying documents ISO 3864, No.B.3.1	 Caution, risk of electric shock ISO 3864, No.B.3.6	 Caution, hot surface IEC 417, No.5041	

Safety Procedures and Precautions

Observe the following general safety precautions during all phases of operation of this instrument. Failure to comply with these precautions or with specific warnings elsewhere in this manual violates safety standards of intended use of the instrument and may impair the protection provided by the equipment. MKS Instruments, Inc. assumes no liability for the customer's failure to comply with these requirements.

DO NOT SUBSTITUTE PARTS OR MODIFY INSTRUMENT

Do not install substitute parts or perform any unauthorized modification to the instrument. Return the instrument to an MKS Calibration and Service Center for service and repair to ensure that all safety features are maintained.

SERVICE BY QUALIFIED PERSONNEL ONLY

Operating personnel must not attempt component replacement and internal adjustments. Any service must be made by qualified service personnel only.

USE CAUTION WHEN OPERATING WITH HAZARDOUS MATERIALS

If hazardous materials are used, users must take responsibility to observe the proper safety precautions, completely purge the instrument when necessary, and ensure that the material used is compatible with the materials in this product, including any sealing materials.

PURGE THE INSTRUMENT

After installing the unit, or before removing it from a system, purge the unit completely with a clean, dry gas to eliminate all traces of the previously used flow material.

USE PROPER PROCEDURES WHEN PURGING

This instrument must be purged under a ventilation hood, and gloves must be worn for protection.

DO NOT OPERATE IN AN EXPLOSIVE ENVIRONMENT

To avoid explosion, do not operate this product in an explosive environment unless it has been specifically certified for such operation.

USE PROPER FITTINGS AND TIGHTENING PROCEDURES

All instrument fittings must be consistent with instrument specifications, and compatible with the intended use of the instrument. Assemble and tighten fittings according to manufacturer's directions.

CHECK FOR LEAK-TIGHT FITTINGS

Carefully check all vacuum component connections to ensure leak-tight installation.

OPERATE AT SAFE INLET PRESSURES

Never operate at pressures higher than the rated maximum pressure (refer to the product specifications for the maximum allowable pressure).

INSTALL A SUITABLE BURST DISC

When operating from a pressurized gas source, install a suitable burst disc in the vacuum system to prevent system explosion should the system pressure rise.

KEEP THE UNIT FREE OF CONTAMINANTS

Do not allow contaminants to enter the unit before or during use. Contamination such as dust, dirt, lint, glass chips, and metal chips may permanently damage the unit or contaminate the process.

ALLOW PROPER WARM UP TIME FOR TEMPERATURE-CONTROLLED UNITS

Temperature-controlled units will only meet specifications when sufficient time is allowed for the unit to meet, and stabilize at, the designed operating temperature. Do not zero or calibrate the unit until the warm up is complete.

Sicherheitshinweise für den Druckmeßumformer

In dieser Betriebsanleitung vorkommende Symbole

Bedeutung der mit WARNUNG!, VORSICHT! und HINWEIS gekennzeichneten Absätze in dieser Betriebsanleitung.

Warnung!



Das Symbol **WARNUNG!** weist auf eine Gefahr für das Bedienpersonal hin. Es macht auf einen Arbeitsablauf, eine Arbeitsweise, einen Zustand oder eine sonstige Gegebenheit aufmerksam, deren unsachgemäße Ausführung bzw. ungenügende Berücksichtigung zu Verletzungen führen kann.

Vorsicht!



Das Symbol **VORSICHT!** weist auf eine Gefahr für das Gerät hin. Es macht auf einen Bedienungsablauf, eine Arbeitsweise oder eine sonstige Gegebenheit aufmerksam, deren unsachgemäße Ausführung bzw. ungenügende Berücksichtigung zu einer Beschädigung oder Zerstörung des Gerätes oder von Teilen des Gerätes führen kann.

Hinweis

















Das Symbol **HINWEIS** macht auf wichtige Informationen bezüglich eines Arbeitsablaufs, einer Arbeitsweise, eines Zustands oder einer sonstige Gegebenheit aufmerksam.

Erklärung der am Gerät angebrachten Symbole

Nachstehender Tabelle sind die Bedeutungen der Symbole zu entnehmen, die am Gerät angebracht sein können.

Tabelle 2: Bedeutung der am Gerät angebrachten Symbole

			
Ein (Energie) IEC 417, No.5007	Aus (Energie) IEC 417, No.5008	Erdanschluß IEC 417, No.5017	Schutzleiteranschluß IEC 417, No.5019
			
Masseanschluß IEC 417, No.5020	Aquipotential- anschluß IEC 417, No.5021	Gleichstrom IEC 417, No.5031	Wechselstrom IEC 417, No.5032
			
Gleich- oder Wechselstrom IEC 417, No.5033-a	Durchgängige doppelte oder verstärkte Isolierung IEC 417, No.5172-a	Dreileiter- Wechselstrom (Drehstrom) IEC 617-2, No.020206	
			
Warnung vor einer Gefahrenstelle (Achtung, Dokumen- tation beachten) ISO 3864, No.B.3.1	Warnung vor gefährlicher elektrischer Spannung ISO 3864, No.B.3.6	Höhere Temperatur an leicht zugänglichen Teilen IEC 417, No.5041	

Sicherheitsvorschriften und Vorsichtsmaßnahmen

Folgende allgemeine Sicherheitsvorschriften sind während allen Betriebsphasen dieses Gerätes zu befolgen. Eine Mißachtung der Sicherheitsvorschriften und sonstiger Warnhinweise in dieser Betriebsanleitung verletzt die für dieses Gerät und seine Bedienung geltenden Sicherheitsstandards, und kann die Schutzvorrichtungen an diesem Gerät wirkungslos machen. MKS Instruments, Inc. haftet nicht für Mißachtung dieser Sicherheitsvorschriften seitens des Kunden.

Niemals Teile austauschen oder Änderungen am Gerät vornehmen!

Ersetzen Sie keine Teile mit baugleichen oder ähnlichen Teilen, und nehmen Sie keine eigenmächtigen Änderungen am Gerät vor. Schicken Sie das Gerät zwecks Wartung und Reparatur an den MKS-Kalibrierungs- und -Kundendienst ein. Nur so wird sichergestellt, daß alle Schutzvorrichtungen voll funktionsfähig bleiben.

Wartung nur durch qualifizierte Fachleute!

Das Auswechseln von Komponenten und das Vornehmen von internen Einstellungen darf nur von qualifizierten Fachleuten durchgeführt werden, niemals vom Bedienpersonal.

Vorsicht beim Arbeiten mit gefährlichen Stoffen!

Wenn gefährliche Stoffe verwendet werden, muß der Bediener die entsprechenden Sicherheitsvorschriften genauestens einhalten, das Gerät, falls erforderlich, vollständig spülen, sowie sicherstellen, daß der Gefahrstoff die am Gerät verwendeten Materialien, insbesondere Dichtungen, nicht angreift.

Spülen des Gerätes mit Gas!

Nach dem Installieren oder vor dem Ausbau aus einem System muß das Gerät unter Einsatz eines reinen Trockengases vollständig gespült werden, um alle Rückstände des Vorgängermediums zu entfernen.

Anweisungen zum Spülen des Gerätes

Das Gerät darf nur unter einer Ablufthaube gespült werden. Schutzhandschuhe sind zu tragen.

Gerät nicht zusammen mit explosiven Stoffen, Gasen oder Dämpfen benutzen!

Um der Gefahr einer Explosion vorzubeugen, darf dieses Gerät niemals zusammen mit (oder in der Nähe von) explosiven Stoffen aller Art eingesetzt werden, sofern es nicht ausdrücklich für diesen Zweck zugelassen ist.

Anweisungen zum Installieren der Armaturen!

Alle Anschlußstücke und Armaturenteile müssen mit der Gerätespezifikation übereinstimmen, und mit dem geplanten Einsatz des Gerätes kompatibel sein. Der Einbau, insbesondere das Anziehen und Abdichten, muß gemäß den Anweisungen des Herstellers vorgenommen werden.

Verbindungen auf Undichtigkeiten prüfen!

Überprüfen Sie sorgfältig alle Verbindungen der Vakuumkomponenten auf undichte Stellen.

Gerät nur unter zulässigen Anschlußdrücken betreiben!

Betreiben Sie das Gerät niemals unter Drücken, die den maximal zulässigen Druck (siehe Produktspezifikationen) übersteigen.

Geeignete Berstscheibe installieren!

Wenn mit einer unter Druck stehenden Gasquelle gearbeitet wird, sollte eine geeignete Berstscheibe in das Vakuumsystem installiert werden, um eine Explosionsgefahr aufgrund von steigendem Systemdruck zu vermeiden.

Verunreinigungen im Gerät vermeiden!

Stellen Sie sicher, daß Verunreinigungen jeglicher Art weder vor dem Einsatz noch während des Betriebs in das Instrumenteninnere gelangen können. Staub- und Schmutzpartikel, Glassplitter oder Metallspäne können das Gerät dauerhaft beschädigen oder Prozeß und Meßwerte verfälschen.

Bei Geräten mit Temperaturkontrolle korrekte Anwärmzeit einhalten!

Temperaturkontrollierte Geräte arbeiten nur dann gemäß ihrer Spezifikation, wenn genügend Zeit zum Erreichen und Stabilisieren der Betriebstemperatur eingeräumt wird. Kalibrierungen und Nulleinstellungen sollten daher nur nach Abschluß des Anwärmvorgangs durchgeführt werden.

Informations relatives à la sécurité pour le transducteur de pression

Symboles utilisés dans ce manuel d'utilisation

Définitions des indications AVERTISSEMENT, ATTENTION, et REMARQUE utilisées dans ce manuel.

Avertissement



L'indication **AVERTISSEMENT** signale un danger pour le personnel. Elle attire l'attention sur une procédure, une pratique, une condition, ou toute autre situation présentant un risque d'accident pour le personnel, en cas d'exécution incorrecte ou de non respect des consignes.

Attention



L'indication **ATTENTION** signale un danger pour l'appareil. Elle attire l'attention sur une procédure d'exploitation, une pratique, ou toute autre situation, présentant un risque d'endommagement ou de destruction d'une partie ou de la totalité de l'appareil, en cas d'exécution incorrecte ou de non respect des consignes.

Remarque

















L'indication **REMARQUE** signale une information importante. Elle attire l'attention sur une procédure, une pratique, une condition, ou toute autre situation, présentant un intérêt particulier.

Symboles apparaissant sur l'unité

Le tableau suivant décrit les symboles pouvant apparaître sur l'unité.

Tableau 3: Définition des symboles apparaissant sur l'unité

			
Marche (sous tension) IEC 417, No.5007	Arrêt (hors tension) IEC 417, No.5008	Terre (masse) IEC 417, No.5017	Terre de protection (masse) IEC 417, No.5019
			
Masse IEC 417, No.5020	Equipotentialité IEC 417, No.5021	Courant continu IEC 417, No.5031	Courant alternatif IEC 417, No.5032
			
Courant continu et alternatif IEC 417, No.5033-a	Matériel de classe II IEC 417, No.5172-a	Courant alternatif triphasé IEC 617-2, No.020206	
			
Attention : se reporter à la documentation ISO 3864, No.B.3.1	Attention : risque de choc électrique ISO 3864, No.B.3.6	Attention : surface brûlante IEC 417, No.5041	

Mesures de sécurité et précautions

Prendre les précautions générales de sécurité suivantes pendant toutes les phases d'exploitation de cet appareil. Le non respect des ces précautions ou des avertissements contenus dans ce manuel constitue une violation des normes de sécurité relatives à l'utilisation de l'appareil et peut diminuer la protection fournie par l'appareil. MKS Instruments, Inc. n'assume aucune responsabilité concernant le non respect des consignes par les clients.

PAS DE SUBSTITUTION DE PIÈCES OU DE MODIFICATION DE L'APPAREIL

Ne pas installer des pièces de substitution ou effectuer des modifications non autorisées sur l'appareil. Renvoyer l'appareil à un centre de service et de calibrage MKS pour tout dépannage ou réparation afin de garantir le l'intégrité des dispositifs de sécurité.

DÉPANNAGE UNIQUEMENT PAR DU PERSONNEL QUALIFIÉ

Le personnel d'exploitation ne doit pas essayer de remplacer des composants ou de faire des réglages internes. Tout dépannage doit être uniquement effectué par du personnel qualifié.

PRÉCAUTION EN CAS D'UTILISATION AVEC DES PRODUITS DANGEREUX

Si des produits dangereux sont utilisés, l'utilisateur est responsable de la prise des mesures de précaution appropriées, de la purge complète de l'appareil quand cela est nécessaire, et de la garantie que les produits utilisés sont compatibles avec les composants de cet appareil, y compris les matériaux d'étanchéité.

PURGE DE L'APPAREIL

Après l'installation de l'unité, ou avant son enlèvement d'un système, purger l'unité complètement avec un gaz propre et sec afin d'éliminer toute trace du produit de flux utilisé précédemment.

UTILISATION DES PROCÉDURES APPROPRIÉES POUR LA PURGE

Cet appareil doit être purgé sous une hotte de ventilation, et il faut porter des gants de protection.

PAS D'EXPLOITATION DANS UN ENVIRONNEMENT EXPLOSIF

Pour éviter toute explosion, ne pas utiliser cet appareil dans un environnement explosif, sauf en cas d'homologation spécifique pour une telle exploitation.

UTILISATION D'ÉQUIPEMENTS APPROPRIÉS ET PROCÉDURES DE SERRAGE

Tous les équipements de l'appareil doivent être cohérents avec ses spécifications, et compatibles avec l'utilisation prévue de l'appareil. Assembler et serrer les équipements conformément aux directives du fabricant.

VÉRIFICATION DE L'ÉTANCHÉITÉ DES CONNEXIONS

Vérifier attentivement toutes les connexions des composants pour le vide afin de garantir l'étanchéité de l'installation.

EXPLOITATION AVEC DES PRESSIONS D'ENTRÉE NON DANGEREUSES

Ne jamais utiliser des pressions supérieures à la pression nominale maximum (se reporter aux spécifications de l'unité pour la pression maximum admissible).

INSTALLATION D'UN DISQUE D'ÉCHAPPEMENT ADAPTÉ

En cas d'exploitation avec une source de gaz pressurisé, installer un disque d'échappement adapté dans le système à vide, afin d'éviter une explosion du système en cas d'augmentation de la pression.

MAINTIEN DE L'UNITÉ À L'ABRI DES CONTAMINATIONS

Ne pas laisser des produits contaminants pénétrer dans l'unité avant ou pendant l'utilisation. Des produits contaminants tels que des poussières et des fragments de tissu, de glace et de métal peuvent endommager l'unité d'une manière permanente ou contaminer le processus.



RESPECT DU TEMPS D'ÉCHAUFFEMENT APPROPRIÉ POUR LES UNITÉS À TEMPÉRATURE CONTRÔLÉE

Les unités à température contrôlée atteignent leurs spécifications uniquement quand on leur laisse un temps suffisant pour atteindre d'une manière stable la température d'exploitation. Ne pas remettre à zéro ou calibrer l'unité tant que l'échauffement n'est pas terminé.

Medidas de seguridad del transductor de presión

Símbolos usados en este manual de instrucciones















Definiciones de los mensajes de advertencia, precaución y de las notas usados en el manual.

Advertencia		El símbolo de advertencia indica la posibilidad de que se produzcan daños personales. Pone de relieve un procedimiento, práctica, estado, etc. que en caso de no realizarse u observarse correctamente puede causar daños personales.
Precaución		El símbolo de precaución indica la posibilidad de producir daños al equipo. Pone de relieve un procedimiento operativo, práctica, estado, etc. que en caso de no realizarse u observarse correctamente puede causar daños o la destrucción total o parcial del equipo.
Nota		El símbolo de notas indica información de importancia. Este símbolo pone de relieve un procedimiento, práctica o condición cuyo conocimiento es esencial destacar.

Símbolos hallados en la unidad

La tabla siguiente contiene los símbolos que puede hallar en la unidad.

Tabla 4: Definición de los símbolos hallados en la unidad

			
Encendido (alimentación eléctrica) IEC 417, N° 5007	Apagado (alimentación eléctrica) IEC 417, N° 5008	Puesta a tierra IEC 417, N° 5017	Protección a tierra IEC 417, N° 5019
			
Caja o chasis IEC 417, N° 5020	Equipotencialidad IEC 417, N° 5021	Corriente continua IEC 417, N° 5031	Corriente alterna IEC 417, N° 5032
			
Corriente continua y alterna IEC 417, N° 5033-a	Equipo de clase II IEC 417, N° 5172-a	Corriente alterna trifásica IEC 617-2, N° 020206	
			
Precaución. Consulte los documentos adjuntos ISO 3864, N° B.3.1	Precaución. Riesgo de descarga eléctrica ISO 3864, N° B.3.6	Precaución. Superficie caliente IEC 417, N° 5041	

Procedimientos y precauciones de seguridad

Las precauciones generales de seguridad descritas a continuación deben observarse durante todas las etapas de funcionamiento del instrumento. La falta de cumplimiento de dichas precauciones o de las advertencias específicas a las que se hace referencia en el manual, constituye una violación de las normas de seguridad establecidas para el uso previsto del instrumento y podría anular la protección proporcionada por el equipo. Si el cliente no cumple dichas precauciones y advertencias, MKS Instruments, Inc. no asume responsabilidad legal alguna.

NO UTILICE PIEZAS NO ORIGINALES O MODIFIQUE EL INSTRUMENTO

No instale piezas que no sean originales ni modifique el instrumento sin autorización. Para asegurar el correcto funcionamiento de todos los dispositivos de seguridad, envíe el instrumento al Centro de servicio y calibración de MKS toda vez que sea necesario repararlo o efectuar tareas de mantenimiento.

LAS REPARACIONES DEBEN SER EFECTUADAS ÚNICAMENTE POR TÉCNICOS AUTORIZADOS

Los operarios no deben intentar reemplazar los componentes o realizar tareas de ajuste en el interior del instrumento. Las tareas de mantenimiento o reparación deben ser realizadas únicamente por personal autorizado.

TENGA CUIDADO CUANDO TRABAJE CON MATERIALES TÓXICOS

Cuando se utilicen materiales tóxicos, es responsabilidad de los operarios tomar las medidas de seguridad correspondientes, purgar totalmente el instrumento cuando sea necesario y comprobar que el material utilizado sea compatible con los materiales del instrumento e inclusive, con todos los materiales de sellado.

PURGUE EL INSTRUMENTO

Una vez instalada la unidad o antes de retirarla del sistema, purgue completamente la unidad con gas limpio y seco para eliminar todo resto de la sustancia líquida empleada anteriormente.

USE PROCEDIMIENTOS ADECUADOS PARA REALIZAR LA PURGA

El instrumento debe purgarse debajo de una campana de ventilación y deben utilizarse guantes protectores.

NO HAGA FUNCIONAR EL INSTRUMENTO EN Ambientes CON RIESGO DE EXPLOSIÓN

Para evitar que se produzcan explosiones, no haga funcionar este instrumento en un Ambiente con riesgo de explosiones, excepto cuando el mismo haya sido certificado específicamente para tal uso.

USE ACCESORIOS ADECUADOS Y REALICE CORRECTAMENTE LOS PROCEDIMIENTOS DE AJUSTE

Todos los accesorios del instrumento deben cumplir las especificaciones del mismo y ser compatibles con el uso que se debe dar al instrumento. Arme y ajuste los accesorios de acuerdo con las instrucciones del fabricante.

COMPRUEBE QUE LAS CONEXIONES SEAN A PRUEBA DE FUGAS

Inspeccione cuidadosamente las conexiones de los componentes de vacío para comprobar que hayan sido instalados a prueba de fugas.

HAGA FUNCIONAR EL INSTRUMENTO CON PRESIONES DE ENTRADA SEGURAS

No haga funcionar nunca el instrumento con presiones superiores a la máxima presión nominal (en las especificaciones del instrumento hallará la presión máxima permitida).

INSTALE UNA CÁPSULA DE SEGURIDAD ADECUADA

Cuando el instrumento funcione con una fuente de gas presurizado, instale una cápsula de seguridad adecuada en el sistema de vacío para evitar que se produzcan explosiones cuando suba la presión del sistema.

MANTENGA LA UNIDAD LIBRE DE CONTAMINANTES

No permita el ingreso de contaminantes en la unidad antes o durante su uso. Los productos contaminantes tales como polvo, suciedad, pelusa, lascas de vidrio o virutas de metal pueden dañar irreparablemente la unidad o contaminar el proceso.

CALIENTE ADECUADAMENTE LAS UNIDADES CONTROLADAS POR MEDIO DE TEMPERATURA

Las unidades controladas por medio de temperatura funcionarán de acuerdo con las especificaciones sólo cuando se las caliente durante el tiempo suficiente para permitir que lleguen y se estabilicen a la temperatura de operación indicada. No calibre la unidad y no la ponga en cero hasta que finalice el procedimiento de calentamiento.

Chapter One: General Information

Introduction

Note

Some Baratron[®] products may not be exported to many end user countries without both US and local government export licenses under ECCN 2B230.

The Type E27F manometer is designed specifically to meet the demands of aggressive etch processes that produce by-products and deposition on typical manometers. The E27F manometer controls its temperature at 45° C (113° F), thereby minimizing the effects of ambient or process temperature variations typically encountered in process line environments.

The E27F sensor's unique features include a contaminant exclusion system (CES)¹ and a deposition baffle, which forces deposition to take place before reaching the sensor.

The MKS Baratron[®] Type E27F Absolute Pressure Etch Manometer is part of the MKS family of general purpose pressure transducers designed to provide accurate, reliable, and repeatable pressure measurements in the range from 1K Torr to as low as 0.02 Torr Full Scale (FS). The instrument operates with ±15 VDC (±5%) input at ≤ 250 mA, and provides 0 to 10 VDC output linear with pressure. It is compliant with current RoHS (Restriction of Hazardous Substances) directives. The E27F manometer exposes only Inconel[®] to the process, permitting use with corrosive or dirty gases and eliminating contamination of the process with transducer materials. Measurements are independent of gas composition and the unit has a minimum measuring range of four decades.

Using the latest single-sided, dual-electrode Inconel transducer design, coupled with a low impedance, fixed-frequency bridge signal conditioner, these instruments are capable of withstanding high overpressure conditions (45 psia) with minimal or no shifts in output over their range. The advanced bridge signal conditioning technology provides high accuracy and operation which is extremely temperature-stable at operating pressure.

Protection from RF interference and noisy electrical environments is increased by the use of a metal case, by internal design elements, and by the use of surge and ESD suppression networks and RFI filtering on all inputs and outputs. The E27F unit meets the testing standards required for the European CE Mark when used with an overall metal braided shielded cable, properly grounded at both ends.

The E27F transducer is available with optional heater status LEDs, two interface connector lock options, and a variety of fittings. The unit is capable of measuring pressure at ambient temperatures of 15° to 40° C (59° to 104° F).

The E27F manometer has the same form, fit, and function as the Types 627B and 627D Absolute Pressure Transducers, and is a “drop-in” replacement for the 627A, 627B, and 627D Baratrons.

¹ US Patent # 5,811,685

How This Manual is Organized

This manual provides instructions on how to set up, install, and operate a Type E27F unit.

Before installing your Type E27F unit in a system or operating it, familiarize yourself with all precautionary notes in the *Safety Messages and Procedures* section at the front of this manual. Obey all WARNING and CAUTION notes in the manual.

- Chapter One *General Information*, (this chapter) introduces the product and describes the organization of the manual.
- Chapter Two *Installation*, explains the environmental requirements and describes how to mount the instrument in your system.
- Chapter Three *Overview*, gives a brief description of the instrument and its functions.
- Chapter Four *Operation*, describes how to use the instrument and explains the functions and features.
- Chapter Five *Maintenance and Troubleshooting*, lists any maintenance required to keep the instrument in good working condition, and provides a checklist for reference should the instrument malfunction.
- Appendix A *Product Specifications*, lists the manometer's specifications.
- Appendix B *Model Code Explanation*, describes the model code used to order the instrument.

Customer Support

Standard maintenance and repair services are available at all regional MKS Calibration and Service Centers, listed on the back cover. MKS also accepts the instruments of other manufacturers for recalibration using the Primary and Transfer Standard calibration equipment at our regional service centers. If any difficulties arise in the use of your Type E27F manometer, or to obtain information about companion products MKS offers, contact any authorized MKS Calibration and Service Center. If it is necessary to return the instrument to MKS, please obtain a Return Materials Authorization (RMA) Number from the MKS Calibration and Service Center before shipping. The RMA Number expedites handling and ensures proper servicing of your instrument.

Please refer to the inside of the back cover of this manual for a list of MKS Calibration and Service Centers.

Warning



All returns to MKS Instruments must be free of harmful, corrosive, radioactive, or toxic materials.

Chapter Two: Installation

How To Unpack the Type E27F Manometer

MKS has carefully packed the Type E27F manometer so that it reaches you in perfect operating order. Upon receiving the unit, however, you should check for defects, cracks, broken connectors, etc., to make sure that the manometer was not damaged in shipment.

Note  Do *not* discard any packing materials until you completed your inspection and are sure the unit arrived safely.

If you find any damage, notify your carrier and MKS immediately. If it is necessary to return the unit to MKS, obtain a Return Material Authorization (RMA) Number from the MKS Service Center before shipping. Please refer to the inside of the back cover of this manual for a list of MKS Calibration and Service Centers.

Unpacking Checklist

Standard Equipment:

- Type E27F Unit
- Type E27F Instruction Manual (this book)

Optional Equipment:

- Electrical Connector Accessories Kit E27F-K1 (includes a mate for the I/O connector)
- Most MKS Power Supply/Readouts
- Most MKS Pressure, Flow, Flow Ratio, and Throttling Valve Controllers
- RM-6 Rack Mount Kit:
19" rack accommodates 1 or 2 readouts and/or controllers
- Interface Cables (see Table 5 on page 20)

Interface Cables

As of July 20, 2009, most products shipped to the European Community must comply with the EMC Directive 2004/108/EC, which covers radio frequency emissions and immunity tests. In addition, as of January 1, 1997, some products shipped to the European Community must also comply with the Product Safety Directive 92/59/EC and Low Voltage Directive 73/23/EC, which cover general safety practices for design and workmanship. MKS products that meet these requirements are identified by application of the CE Mark.

To ensure compliance with EMC Directive 2004/108/EC, an overall metal braided shielded cable, properly grounded at both ends, is required during use. No additional installation requirements are necessary to ensure compliance with Directives 92/59/EC and 73/23/EC.

Note

- An overall metal braided, shielded cable, properly grounded at both ends, is required during use to meet CE specifications.
- To order an overall metal braided shielded cable, add an “S” after the cable type designation. For example, to order a cable to connect a E27F unit to a 651 controller, use part number CB259-5-10; for a metal braided shielded cable use part number CB259S-5-10.

You can purchase interface cables to all MKS companion products from MKS (refer to Table 5), or you can make cables that meet the appropriate specifications. For cables connecting to non-MKS products, MKS can provide normal shielding or braided shielded cable assemblies in a nominal 10' (3m) length, terminating in flying leads (pigtails) at both ends.

Overall metal braided shielded cable assemblies, properly grounded at both ends, are recommended if the environment contains high EMI/RFI noise.

Table 5: Interface Cables

To Connect the E27F to...	Use the MKS Cable...	
	Standard	Shielded
PDR-C-1C/2C, PDR-5B, Power Supply/Readouts	CB127-1-10	CB127S-1-10
146, 186, 651, 652 Controllers: PR4000 Readout	CB259-5-10	CB259S-5-10

Generic Shielded Cable Guidelines

Follow the guidelines listed below if you choose to manufacture your own cables.

1. The cable must have an overall metal *braided* shield, covering all wires. Neither aluminum foil nor spiral shielding are as effective; using either may nullify regulatory compliance.
2. The connectors must have a metal case that has direct contact to the cable's shield on the whole circumference of the cable. The inductance of a flying lead or wire from the shield to the connector will seriously degrade the shield's effectiveness. The shield should be grounded to the connector before its internal wires exit.
3. With very few exceptions, the connector(s) must make good contact to the device's case (ground). “Good contact” is about 0.01 ohms and the ground should surround all wires. Contact to ground at just one point may not suffice.
4. For shielded cables with flying leads at one or both ends, it is important at each such end to ground the shield *before* the wires exit. Make this ground with absolute minimum length. (A ¼ inch piece of #22 wire may be undesirably long since it has approximately 5 nH of inductance, equivalent to 31 ohms at 1000 MHz). After picking up the braid's ground, keep the wires and braid flat against the case.

With very few exceptions, grounded metal covers are not required over terminal strips. If one is required, it will be stated in the Declaration of Conformity or in the instruction manual.

5. In selecting the appropriate type and wire size for cables, consider:
 - A. Voltage ratings.
 - B. Cumulative I^2R heating of all the conductors (keep them safely cool).

- C. IR drop of the conductors, so that adequate power or signal voltage gets to the device.
- D. Capacitance and inductance of cables that are handling fast signals (such as data lines or stepper motor drive cables).
- E. Some cables may need internal shielding from specific wires to others. Please see the instruction manual for details regarding this matter.

Product Location and Requirements

Ambient Operating Temperature

The acceptable ambient operating temperature range for the E27F manometer is 15° to 40° C (59° to 104° F). The unit is temperature controlled at 45° C (113° F).

Note



The maximum temperature specification is provided for general guidance under ideal conditions. If the switch is located in an enclosed environment or where air flow is limited or impeded in any way please consult your local MKS office for additional guidance.

Power Requirements

The E27F manometer requires an external power source supplying ± 15 VDC ($\pm 5\%$) at ≤ 250 mA. Noise and ripple should be less than 20 mV peak-to-peak. You may use any readout device which has input capabilities of less than 0 to greater than 10 VDC, and impedance greater than 10K ohms. The power is introduced to the unit through the Interface connector on the top panel of the transducer (see Figure 4 on page 28).

Setup

Dimensions

Note  All dimensions are listed in inches (with millimeters referenced in parentheses). Tolerances are ± 0.1 (X.X) and ± 0.01 (X.XX).

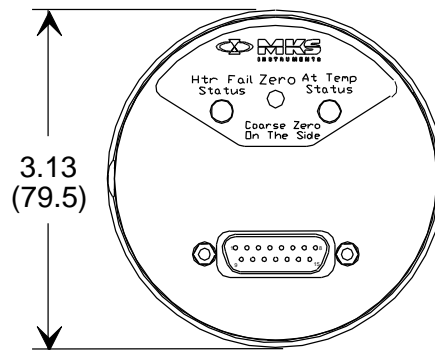

Figure 1: Top View Dimensions
(shown with the optional heater status LEDs)

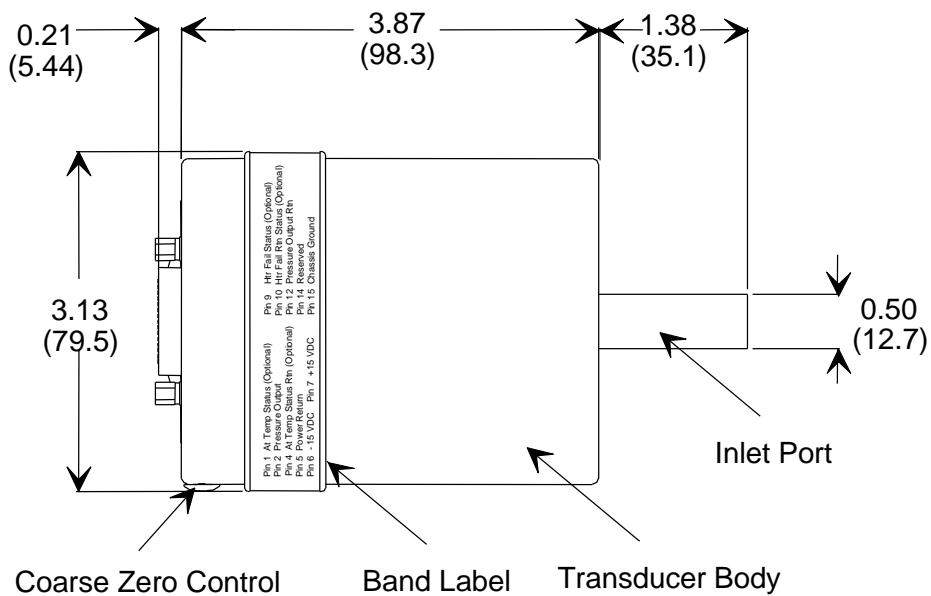

Figure 2: Side View Dimensions

Fittings

The E27F manometer is available with the following fittings:

- ½" diameter (12.7 mm) tubulation
- Swagelok® 8-VCR® (female)
- Mini-CF (rotatable)
- NW16-KF
- NW25-KF
- Swagelok 8-VCO® (female)

Mounting Instructions

Mount the manometer with the inlet port pointing (vertically) downward. The port easily carries the weight of the device.

Although the unit can be mounted in any attitude, mounting it as suggested allows any foreign matter entering the pressure port to fall away from the diaphragm.

Isolate the unit from vibration as much as possible. At low pressures, the diaphragm may be subject to resonance because of the lack of gas damping. The low range transducers (≤ 1 Torr) are very sensitive; isolate them from any vibration. Remember to isolate from vibration through the cable as well as through the port.

Electrical Information

Grounding

Note  The ground of any external power supply and readout should be the same as the transducer ground (chassis ground) to minimize any possible ground loops which can affect the performance and stability of the system.

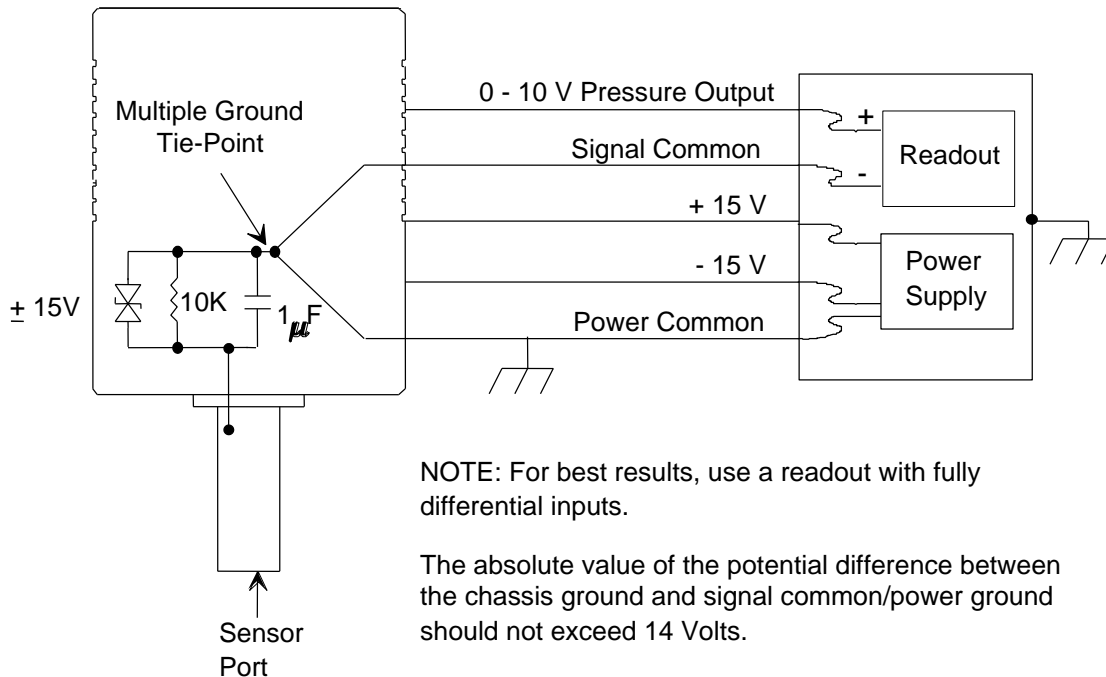

Figure 3: Power, Signal, and Chassis Grounding Scheme Example

Interface Connector

The 15-pin male Type “D” Interface connector on the top of the unit (see Figure 4 on page 28) provides access to the power input and heater status pins. The pinout is listed in Table 6 on page 25. The connector is available with either thread locks or slide locks.

Thread Locks

The 15-pin connector with thread locks uses threaded posts onto which the mating connector is mechanically fastened with screws. This is the standard MKS style Type “D” connector.

Slide Locks

The 15-pin connector with slide locks uses slotted posts onto which the mating connector is mechanically fastened by a slide mechanism which engages the slots in the posts.

Note  Standard MKS interface cables are not available for units that have a slide lock connector.

Table 6: Interface Connector Pinout

Pin Number	Assignment
1	At Temperature Status* or Reserved
2	Pressure Signal Output
3	No Connection
4	At Temperature Status Return* or Reserved
5	Power Return (Power Common)
6	-15 VDC
7	+15 VDC
8	No Connection
9	Heater Failure Status* or Reserved
10	Heater Failure Status Return* or Reserved
11	No Connection
12	Pressure Signal Output Return (Signal Common)
13	No Connection
14	Reserved
15	Chassis Ground
<i>* Valid only with the heater status LED option.</i>	

Note

The “Reserved” pin assignment denotes a pin with an internal connection that may be assigned a function in the future.

The “No Connection” pin assignment denotes a pin with no internal connection.

Startup

After installation, allow your transducer to warm up until it is stabilized, then check the transducer zero to verify the proper output. Refer to *How to Adjust the Zero*, on page 31, for complete instructions on adjusting the zero controls on the E27F unit.

Warm Up Time

Allow enough time for your transducer to warm up.

Warm up times for 23° C ambient temperature conditions are:

- 2 hours for ≥ 1 Torr units
- 4 hours for < 1 Torr units

Note



The transducer must be *fully stabilized* before you make any zero adjustments.

Chapter Three: Overview

General Information

A complete pressure transducer system requires three components to convert pressure to a linear DC voltage output: a sensor, signal conditioner, and power supply. The E27F manometer contains the sensor and signal conditioner.

An MKS or MKS-compatible power supply is required to complete the pressure to DC voltage conversion. For a direct readout of the pressure measurement, a meter (analog or digital) is required.

Sensor

The E27F manometer is a variable capacitance sensor consisting of a pressure inlet tube (port) connected to a small chamber in the transducer body. One wall of this chamber is an elastic metal diaphragm. The front side of the diaphragm is exposed to the gas whose pressure is to be measured. The back, or *reference*, side of the diaphragm faces a rigidly mounted ceramic disc containing two electrodes. The reference side is permanently evacuated (10^{-7} Torr); its vacuum is maintained with a chemical getter system.

The diaphragm deflects with changing absolute pressure (force per unit area) independent of the gas type or composition of the measured gas. This deflection causes an imbalance of the sensor electrode capacitances, since the distance to the diaphragm becomes different for each electrode. The imbalance of capacitances is converted to a DC voltage in the bridge, which is excited by a precision constant frequency oscillator. The resultant signal is linearized, zeroed, and amplified by the signal conditioner electronics to produce a precise 0 to 10 VDC signal scaled to the range of the transducer.

Zero and span stability of the heated E27F manometer are further increased because the sensor and bridge electronics are temperature controlled. This thermal enclosure reduces the effects of ambient temperature changes by a factor of at least 35 (a 35° C change in ambient temperature produces less than a 1° C change inside the thermal housing).

Signal Conditioner/Electronics

The signal conditioner contains state-of-the-art, low impedance balanced bridge circuitry, self-compensated for thermal stability with ambient temperature changes. The output is a DC voltage which is linear with pressure. The transducer is calibrated against a pressure standard to provide a 0 to 10 Volt DC output over the range of the transducer.

Instrument Components

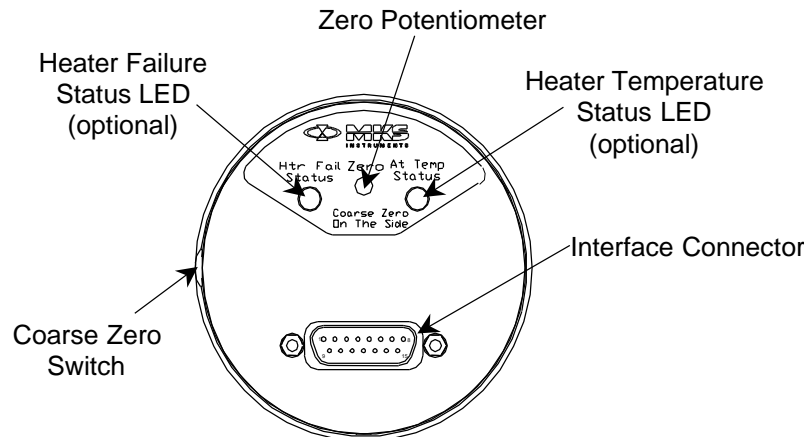

Figure 4: Top View of the E27F Manometer
(shown with the optional heater status LEDs)

Coarse Zero Switch

This multi-position switch adjusts the transducer zero if the ZERO potentiometer fails to provide enough zero adjustment. See *How To Adjust the Coarse Zero Switch* on page 32 for more information.

Optional Heater Status LEDs and Semiconductor Switches

When the temperature of the sensor is within the controlled temperature window ($45^{\circ}\text{C} \pm 4^{\circ}\text{C}$) the “At Temperature Status” LED illuminates green, and the corresponding semiconductor switch (pins 1 and 4 on the Interface connector) closes. If a heater failure occurs, the bi-color “Htr Fail Status” LED blinks red (normally it is green), and the corresponding semiconductor switch (pins 9 and 10 on the Interface connector) opens. See *Optional Semiconductor Switch Specification* on page 38, for more information.

Zero Potentiometer

This potentiometer adjusts the transducer zero. See *How To Adjust the Zero Potentiometer* on page 31 for more information.

Interface Connector

The 15-pin male Type “D” Interface connector provides access to the power input and heater status pins. Refer to Table 6 on page 25 for the connector pinout.

Labels

Note  The figures showing the instrument labels (Figures 5 through 8) are not drawn to scale.

Top Panel Labels

The label on the top panel of the E27F manometer identifies the ZERO potentiometer, and if present, the optional Heater Failure and Temperature Status LEDs.

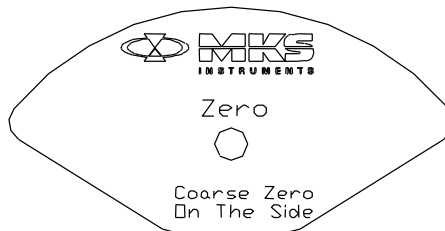

Figure 5: Top Panel Label for Units Without Optional Heater Status LEDs

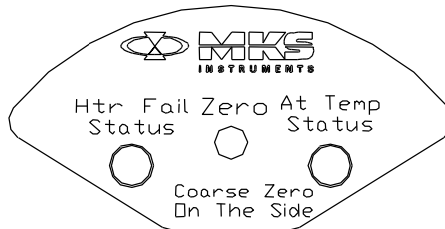

Figure 6: Top Panel Label for Units With Optional Heater Status LEDs

Band Label

The band label, which is wrapped around the center of the transducer body, lists the pinout for the unit's 15-pin Interface connector (Table 6 on page 25). Note that pins 1, 4, 9, and 10 are "Reserved" on units without the optional heater status LEDs.

 MKS INSTRUMENTS  BARATRON ETCH MANOMETER	Pin 1 At Temp Status (Optional)	Pin 9 Htr Fail Status (Optional)
	Pin 2 Pressure Output	Pin 10 Htr Fail Rtn Status (Optional)
	Pin 4 At Temp Status Rtn (Optional)	Pin 12 Pressure Output Rtn
	Pin 5 Power Return	Pin 14 Reserved
	Pin 6 -15 VDC Pin 7 +15 VDC	Pin 15 Chassis Ground

Figure 7: Band Label

Serial Number Label

The serial number label on the seam of the band label lists the unit's serial number, model code, full scale range, input voltage, and output voltage. The label also displays the CE mark signifying compliance with the European CE regulations.

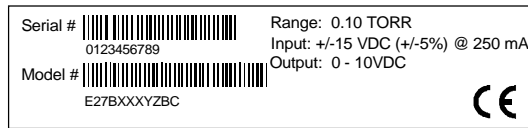

Figure 8: Serial Number Label

The options for your transducer are identified in the model code when you order the unit. See *Appendix B: Model Code Explanation* on page 39 for more information.

Chapter Four: Operation

How to Adjust the Zero

All pressure transducers require initial and periodic zero adjustments. Before initial operation, and during periodic maintenance, check the transducer zero to verify the proper output. Set (or reset) the zero by adjusting the ZERO potentiometer on the top of the transducer (see *How To Adjust the Zero Potentiometer*) or at the front panel of any MKS Power Supply/Readout being used. If the ZERO potentiometer fails to provide enough adjustment, use the COARSE ZERO switch (see *How To Adjust the Coarse Zero Switch* on page 32.)

To achieve the full dynamic range specified for the transducer, the zero adjustment must be made at a pressure less than the transducer's resolution (0.001% of FS). Low range transducers should be pumped for at least one hour after exposure to air to remove any moisture and to allow the pressure to stabilize. Zeroing a transducer above its minimum resolution creates a *zero offset* relative to true absolute pressure. All subsequent readings are then linear and accurate *relative to the offset*.

Note

If available pressures are not low enough to set the transducer zero, a vacuum leak detector with sufficient vacuum pumping can be used to achieve proper zeroing pressures. In this case, mount the transducer on the leak detector *in the same attitude as during actual use*.

How To Adjust the Zero Potentiometer

To adjust the ZERO potentiometer:

1. Install the transducer in a system and connect a power supply/readout.
2. Power the transducer and allow it to warm up and stabilize.
3. Pump the unit down to a pressure below its resolution (0.001% of FS).

Note

Allow 2 hours warm up for ≥ 1 Torr units, and 4 hours for < 1 Torr units. Make sure the transducer is *fully stabilized* before adjusting the zero.

For best results, pump the transducer while it is warming up. See Table 7 on page 32 for the highest recommended pressure levels for proper zero adjustment.

Table 7: Highest Pressures Suggested for Proper Zero Adjustment

Full Scale Range (Torr)	Highest Pressure for Proper Zero Adjustment (Torr)
0.02	2×10^{-7}
0.05	5×10^{-7}
0.1	1×10^{-6}
0.25	2.5×10^{-6}
1.0	1×10^{-5}
2.0	2×10^{-5}
10	1×10^{-4}
20	2×10^{-4}
100	1×10^{-3}

- Adjust the ZERO pot with a small screwdriver until the readout displays zero (0000).
The zero potentiometer provides ample control under normal conditions. If the zero potentiometer fails to provide enough adjustment, use the coarse zero switch on the side of the unit (see Figure 4 on page 28). See *How To Adjust the Coarse Zero Switch*, below, for more information.

How To Adjust the Coarse Zero Switch

To adjust the COARSE ZERO switch:

Note  Use the COARSE ZERO switch only if the ZERO potentiometer fails to provide enough adjustment.

- Install the transducer in a system and connect a power supply/readout.
- Power the transducer and allow it to warm up and stabilize.
- Pump the unit down to a pressure below its resolution.
For best results, pump the transducer while it is warming up. Refer to Table 7 on page 32 for the highest recommended pressure levels for proper zero adjustment.
- Center the ZERO pot on top of the transducer by adjusting the screw to leave an equal amount of adjustment both clockwise and counterclockwise.
- Remove the plug that covers the COARSE ZERO switch. (See Figure 4 on page 28.)
- Turn the COARSE ZERO switch to a position that produces the output signal closest to 0 Volts.
- Adjust the ZERO pot to bring the output to exactly 0 Volts. (See *How To Adjust the Zero Potentiometer* on page 31, for more information.)
- Cover the COARSE ZERO switch with the plug removed in step 5.

Suggested Pressures for Reading and Control

The lowest suggested pressures for reading and control with the E27F manometer are listed in Table 8.

Table 8: Lowest Suggested Pressures for Reading and Control

Full Scale Range (Torr)	Lowest Suggested Pressure for Reading (Torr)	Lowest Suggested Pressure for Control (Torr)
0.02	1×10^{-5}	1×10^{-4}
0.05	2.5×10^{-5}	2.5×10^{-4}
0.1	5×10^{-5}	5×10^{-4}
0.25	1.25×10^{-4}	1.25×10^{-3}
1.0	5×10^{-4}	5×10^{-3}
2.0	1×10^{-3}	1×10^{-2}
10	5×10^{-3}	5×10^{-2}
20	1×10^{-2}	1×10^{-1}
100	5×10^{-2}	5×10^{-1}

Lowest Suggested Pressure Available for Reading

The middle column of Table 8 lists reliable and practical pressures for different range transducers. Lower readings may be obtained in environments with stable temperature and air flow.

Lowest Suggested Pressure to Use for Control

The last column of Table 8 lists reference pressures representing the pressure reading of the transducer at 50 mV signal output. A DC signal level of at least 50 mV is the recommended minimum to use when integrating any transducer into a complex processing system.

This page intentionally left blank.

Chapter Five: Maintenance and Troubleshooting

General Information

If the E27F manometer fails to operate properly when received, check for shipping damage, and check the cables for correct continuity. Any damage should be reported to the carrier and MKS Instruments immediately.

If there is no obvious damage and the continuity is correct, check your instrument using the troubleshooting chart (Table 9 on page 36). If the transducer performance does not improve and it is necessary to return the unit to MKS for service, obtain a Return Material Authorization (RMA) Number from any MKS Calibration and Service center before shipping. Please refer to the inside back cover of this manual for a list of MKS Calibration and Service Centers.

Maintenance

The E27F manometer usually requires no maintenance other than proper installation and operation, and an occasional zero adjustment. Periodically, check the cables for wear, and inspect the enclosure for visible signs of damage.

Zero Adjustment

The manometer zero can be set (or reset) by adjusting the ZERO potentiometer on the top panel of the unit (refer to Figure 4 on page 28), or at the front panel of any MKS or MKS-compatible power supply being used. Refer to *How to Adjust the Zero* on page 31 for complete instructions on how to adjust the manometer's zero controls.

Note



- In production operations such as semiconductor manufacturing, verify the manometer zero (adjust if necessary) each time the equipment is shut down for routine maintenance.
- The zero adjustments are the **only** adjustments that can be made in the field. Return the manometer to MKS Instruments for other adjustments, calibration, or servicing.

Troubleshooting

Table 9: Troubleshooting Chart

Symptom	Possible Cause	Solution
Overrange positive or negative signal.	A shorted transducer, damaged cable between the transducer and electronics module, or pressures greater than full scale can cause the output signal to exceed +10 VDC.	Measure supply voltages at the connector. Lower pressure. Inspect cable and transducer. Replace if necessary.
Measurement slowly goes positive or negative over time.	Overpressure and/or a build-up of contamination in the measurement cavity.	Return to MKS for servicing or transducer replacement.
Unstable zero output.	The ambient temperature may be too high. <i>or</i> The ambient temperature is varying over a wide range.	Ensure the ambient temperature is within product requirements. Refer to <i>Appendix A: Product Specifications</i> , page 37.

Appendix A: Product Specifications

Electrical Specifications

CE Compliance Electromagnetic Compatibility ² Product Safety Requirements	EMC Directive 2004/108/EC Product Safety Directive 92/59/EC
RoHS (Restriction of Hazardous Substances) Compliance	Fully compliant to Directive 2002/95/EC
Input Power Requirements Voltage Current	±15 VDC ±5% ≥ 250 mA

Environmental Specifications

Ambient Operating Temperature Range	15° to 40° C (59° to 104° F)
Maximum External Case Temperature	50° C (122° F)
Storage Humidity Range	≤ 95% Relative Humidity, non-condensing
Storage Temperature Range	-20° to 80° C (-4° to 176° F)

Performance Specifications

Accuracy (non-linearity, hysteresis, and non-repeatability) ≥ 1 Torr units 0.25, 0.1 and 0.05 Torr units 0.02 Torr units	±0.12% of Reading ±0.15% of Reading ±0.25% of Reading
Burst Pressure	5 times full scale or 90 psia, whichever is greater
Internal Volume	6.3 cc
Leak Integrity	Internal to external 10^{-9} scc/sec He
Overpressure Limit Without Damage	45 psia (310 kPa)
Pressure Ranges (Torr FS)	0.02, 0.05, 0.1, 0.25, 1.0, 2.0, 10, 20, 100
Resolution	0.001% (1×10^{-5}) of FS

(Continued on next page)

² An overall metal braided shielded cable, properly grounded at both ends, is required during use.

Temperature Coefficients Zero ≥ 1 Torr units 0.1. 0.25 Torr units 0.05 Torr units 0.02 Torr units Span (all ranges)	0.002% FS/ °C 0.005% FS/ °C 0.015% FS/ °C 0.030% FS/ °C 0.02% Reading/ °C
Time Response	< 20 msec (< 40 msec for ≤ 1 Torr units)
Warm Up Time (for 23° C ambient temperature conditions) ≥ 1 Torr units < 1 Torr units	2 hours 4 hours
Zero Adjustment Range Zero Potentiometer Coarse Zero Switch	$\pm 1.0\%$ $\pm 20\%$

Physical Specifications

Fittings	½” Diameter (12.7 mm) tubulation, Swagelok 8-VCR (female), Mini-CF (rotatable), NW16-KF, NW25-KF, Swagelok 8-VCO (female)
Interface Connector	15-pin male Type “D”
Weight	1.5 lbs (0.68 Kg)
Wetted Materials	Inconel [®] . Some optional fittings may be constructed from 300-series stainless steel.

Optional Semiconductor Switch Specification

Current Carrying Capacity	120 mA, maximum
Switch-on resistance	20Ω max. (120 mA, 50° C)
Open Circuit Voltage	25 V, maximum
Zener Protection	28 V, nominal

Due to continuing research and development activities, these product specifications are subject to change without notice.

Appendix B: Model Code Explanation

Model Code

The options of your manometer are identified in the model code when you order the unit. The model code is identified as follows:

E27F XXX Y Z B C

where:

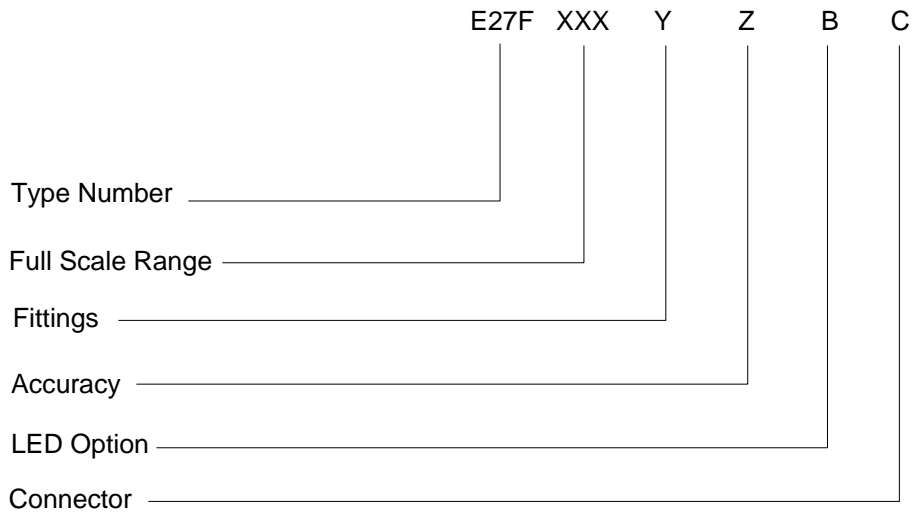

Type Number (E27F)

This designates the model number of the instrument.

Full Scale Range (XXX)

The full scale range in Torr is indicated by a two-digit/one-letter code.

Full Scale Range	Ordering Code
0.02	U2T
0.05	U5T
0.1	.1T
0.25	RET
1.0	01T
2.0	02T
10	11T
20	21T
100	12T

Fittings (Y)

Six types of fittings are available, designated by a single letter code.

Fittings	Ordering Code
½" Diameter tubulation	A
Swagelok 8-VCR (female)	B
Mini-CF (rotatable)	C
NW16-KF	D
2 ¾" Con-Flat (rotatable)	L
NW25-KF	Q
Swagelok 8-VCO female	E

Accuracy (Z)

Three specifications for accuracy are available, designated by a single letter code.

Accuracy	Ordering Code
0.12% of Reading (≥ 1 Torr units)	C
0.15% of Reading (0.1, 0.25, and 0.05 Torr units)	D
0.25% of Reading (0.02 Torr units)	E

LED Option (B)

The unit is available with or without the heater status LEDs, designated by a single letter code.

LED Option	Ordering Code
Standard (No status LEDs)/Vertical Calibration	1
Heater Failure / Heater Temperature Status LEDs/Vertical Calibration	2
Standard (No status LEDs)/Horizontal Calibration	3
Heater Failure / Heater Temperature Status LEDs/Horizontal Calibration	4

Connector (C)

Two configurations of the 15-pin Type "D" connector are available, designated by a single letter code.

Connector	Ordering
------------------	-----------------

	Code
15-pin Type "D" connector with thread locks	B
15-pin Type "D" connector with slide locks	P

Index

A

Accuracy, 40

B

Band label, 29

C

Cables

generic shielded, 20

CE mark, 17, 30

Coarse zero switch, description of, 28

Connectors

CT27 unit, 24–25

Customer support, 18

F

Fittings, 38, 40

full scale range, 39

Full scale range, 39

G

Grounding, 24

H

Heater status option, 28

I

Interface connector, 28

L

Labels

band label, 29

serial number, 30

top panel, 29

M

Manual organization, 18

Model code, 39–40, 39

Mounting Instructions, 23

O

Optional equipment, 19

Options

heater status LEDs, 28

interface connector, 24

interface connectors, 17

P

Power requirements, 21, 37

Pressure

highest for zero adjustment, 32

lowest for control, 33

lowest for reading, 33

R

Returning the product, 18, 19

RoHS (Restriction of Hazardous Substances), 17, 37

S

Safety information, 1–16

Sensor, description of, 27

Serial number label, 30

Setup

grounding, 24

mounting instructions, 23

power requirements, 21

slide locks, 24

- specifications, 37
- standard equipment, 19
- startup, 26
- Signal Conditioner/Electronics, 27

T

Temperature

- operating**, 21
- storage, 37
- Thread locks, 24
- Top panel labels, 29
- Troubleshooting, 36

W

- Warm up time**, 26

Z

- Zero adjustment
 - coarse zero switch, 28, 32, 38
 - zero potentiometer, 28, 31, 38
- Zero potentiometer, description of, 28