

**MKS Baratron®**  
**Type D24D/D25D Dual Range**  
**Absolute Pressure Transducers**  
**With Trip Point Relays**

*Copyright © 2009 by MKS Instruments, Inc.*

*All rights reserved. No part of this work may be reproduced or transmitted in any form or by any means, electronic or mechanical, including photocopying and recording, or by any information storage or retrieval system, except as may be expressly permitted in writing by MKS Instruments, Inc.*

*Printed in the United States of America*

Baratron® is a registered trademark of MKS Instruments, Inc., Andover, MA

Swagelok®, VCR®, and VCO® are registered trademarks of Swagelok Co., Solon, OH

Inconel® is a registered trademark of Inco Alloys International, Inc., Huntington, WV

## Table of Contents

Pressure Transducer Safety Information .....	8
Symbols Used in This Instruction Manual.....	8
Symbols Found on the Unit .....	9
Safety Procedures and Precautions .....	10
Sicherheitshinweise für den Druckmeßumformer .....	12
In dieser Betriebsanleitung vorkommende Symbole .....	12
Erklärung der am Gerät angebrachten Symbole .....	13
Sicherheitsvorschriften und Vorsichtsmaßnahmen.....	14
Informations relatives à la sécurité pour le transducteur de pression .....	16
Symboles utilisés dans ce manuel d'utilisation .....	16
Symboles apparaissant sur l'unité .....	17
Mesures de sécurité et précautions .....	18
Medidas de seguridad del transductor de presión .....	20
Símbolos usados en este manual de instrucciones .....	20
Símbolos hallados en la unidad.....	21
Procedimientos y precauciones de seguridad.....	22
Chapter One: General Information .....	24
Introduction.....	24
How This Manual is Organized .....	25
Customer Support .....	25
Chapter Two: Installation .....	27
How To Unpack the Type D24D or D25D Unit.....	27
Unpacking Checklist.....	27
Interface Cables .....	28
Generic Shielded Cables .....	29
Product Location and Requirements.....	31
Fittings .....	31
Setup .....	32

Dimensions .....	32
Mounting Instructions.....	32
Electrical Information .....	33
Interface Connectors .....	35
15-Pin Interface Connector Pinout.....	36
Terminal Block Adapter Pinout .....	37
Startup.....	38
Chapter Three: Overview.....	39
General Information.....	39
Sensor.....	39
Signal Conditioner/Electronics .....	39
The Endcap .....	40
Hysteresis.....	40
Label .....	42
Chapter Four: Operation .....	43
General Information.....	43
Lowest Suggested Pressures for Reading and Control .....	43
How To Adjust the Zero .....	44
How To Set the Trip Points .....	45
How To Adjust the Trip Point Direction .....	46
How To Adjust the Trip Point Hysteresis.....	49
Chapter Five: Maintenance and Troubleshooting.....	51
General Information.....	51
Maintenance.....	51
Zero Adjustment .....	51
How To Clean the Unit.....	51
Troubleshooting.....	52
Appendix A: Product Specifications.....	53
Type D24D Transducer.....	53
Type D25D Transducer.....	54
Appendix B: Model Code Explanation.....	57
Model Code.....	57

Index .....59



## List of Figures and Tables

### **Figures**

Figure 1: Preferred Method To Connect an Overall Metal Braided Shielded Cable .....	30
Figure 2: Alternate Method To Connect an Overall Metal Braided Shielded Cable .....	30
Figure 3: Dimensions of the D24 and D25 Transducers.....	32
Figure 4: Power, Signal, and Chassis Grounding Scheme.....	34
Figure 5: The Endcap.....	40
Figure 6: How Hysteresis Effects Accuracy and Relay Chatter .....	41
Figure 7: Serial Number Label .....	42
Figure 8: How To Measure the Trip Point Voltage .....	45
Figure 9: The Relay Board.....	47

### **Tables**

Table 1: Definition of Symbols Found on the Unit .....	9
Tabelle 2: Bedeutung der am Gerät angebrachten Symbole.....	13
Tableau 3: Définition des symboles apparaissant sur l'unité .....	17
Tabla 4: Definición de los símbolos hallados en la unidad.....	21
Table 5: Interface Cables .....	28
Table 6: Required Inputs for the D24D and D25D Transducers .....	33
Table 7: 15-Pin “D” Style Interface Connector Pinout.....	36
Table 8: Terminal Block Adapter Pinout.....	37
Table 9: Suggested Pressures for Reading and Control.....	43
Table 10: Highest Pressure Suggested for Proper Zero Adjustment.....	44
Table 11: Factory-Set Positions of the Shorting Jumpers.....	48
Table 12: Shorting Jumper Positions for Hysteresis.....	49
Table 13: Troubleshooting Chart.....	52

## Pressure Transducer Safety Information

### Symbols Used in This Instruction Manual

Definitions of WARNING, CAUTION, and NOTE messages used throughout the manual.

**Warning**



---

The **WARNING** sign denotes a hazard to personnel. It calls attention to a procedure, practice, condition, or the like, which, if not correctly performed or adhered to, could result in injury to personnel.

---

**Caution**



---

The **CAUTION** sign denotes a hazard to equipment. It calls attention to an operating procedure, practice, or the like, which, if not correctly performed or adhered to, could result in damage to or destruction of all or part of the product.

---

**Note**



---

The **NOTE** sign denotes important information. It calls attention to a procedure, practice, condition, or the like, which is essential to highlight.

---



## Symbols Found on the Unit

The following table describes symbols that may be found on the unit.















Definition of Symbols Found on the Unit			
 On (Supply) IEC 417, No.5007	 Off (Supply) IEC 417, No.5008	 Earth (ground) IEC 417, No.5017	 Protective earth (ground) IEC 417, No.5019
 Frame or chassis IEC 417, No.5020	 Equipotentiality IEC 417, No.5021	 Direct current IEC 417, No.5031	 Alternating current IEC 417, No.5032
 Both direct and alternating current IEC 417, No.5033-a	 Class II equipment IEC 417, No.5172-a	 Three phase alternating current IEC 617-2 No.020206	
 Caution, refer to accompanying documents ISO 3864, No.B.3.1	 Caution, risk of electric shock ISO 3864, No.B.3.6	 Caution, hot surface IEC 417, No.5041	

Table 1: Definition of Symbols Found on the Unit

## **Safety Procedures and Precautions**

**Observe the following general safety precautions during all phases of operation of this instrument. Failure to comply with these precautions or with specific warnings elsewhere in this manual violates safety standards of intended use of the instrument and may impair the protection provided by the equipment. MKS Instruments, Inc. assumes no liability for the customer's failure to comply with these requirements.**

### **DO NOT SUBSTITUTE PARTS OR MODIFY INSTRUMENT**

Do not install substitute parts or perform any unauthorized modification to the instrument. Return the instrument to an MKS Calibration and Service Center for service and repair to ensure that all safety features are maintained.

### **SERVICE BY QUALIFIED PERSONNEL ONLY**

Operating personnel must not attempt component replacement and internal adjustments. Any service must be made by qualified service personnel only.

### **USE CAUTION WHEN OPERATING WITH HAZARDOUS MATERIALS**

If hazardous materials are used, users must take responsibility to observe the proper safety precautions, completely purge the instrument when necessary, and ensure that the material used is compatible with the materials in this product, including any sealing materials.

### **PURGE THE INSTRUMENT**

After installing the unit, or before removing it from a system, purge the unit completely with a clean, dry gas to eliminate all traces of the previously used flow material.

### **USE PROPER PROCEDURES WHEN PURGING**

This instrument must be purged under a ventilation hood, and gloves must be worn for protection.

### **DO NOT OPERATE IN AN EXPLOSIVE ENVIRONMENT**

To avoid explosion, do not operate this product in an explosive environment unless it has been specifically certified for such operation.

### **USE PROPER FITTINGS AND TIGHTENING PROCEDURES**

All instrument fittings must be consistent with instrument specifications, and compatible with the intended use of the instrument. Assemble and tighten fittings according to manufacturer's directions.

### **CHECK FOR LEAK-TIGHT FITTINGS**

Carefully check all vacuum component connections to ensure leak-tight installation.

**OPERATE AT SAFE INLET PRESSURES**

Never operate at pressures higher than the rated maximum pressure (refer to the product specifications for the maximum allowable pressure).

**INSTALL A SUITABLE BURST DISC**

When operating from a pressurized gas source, install a suitable burst disc in the vacuum system to prevent system explosion should the system pressure rise.

**KEEP THE UNIT FREE OF CONTAMINANTS**

Do not allow contaminants to enter the unit before or during use. Contamination such as dust, dirt, lint, glass chips, and metal chips may permanently damage the unit or contaminate the process.

**ALLOW PROPER WARM UP TIME FOR TEMPERATURE-CONTROLLED UNITS**

Temperature-controlled units will only meet specifications when sufficient time is allowed for the unit to meet, and stabilize at, the designed operating temperature. Do not zero or calibrate the unit until the warm up is complete.

## Sicherheitshinweise für den Druckmeßumformer

### In dieser Betriebsanleitung vorkommende Symbole

Bedeutung der mit WARNUNG!, VORSICHT! und HINWEIS gekennzeichneten Absätze in dieser Betriebsanleitung.

**Warnung!**



---

Das Symbol **WARNUNG!** weist auf eine Gefahr für das Bedienpersonal hin. Es macht auf einen Arbeitsablauf, eine Arbeitsweise, einen Zustand oder eine sonstige Gegebenheit aufmerksam, deren unsachgemäße Ausführung bzw. ungenügende Berücksichtigung zu Verletzungen führen kann.

---

**Vorsicht!**



---

Das Symbol **VORSICHT!** weist auf eine Gefahr für das Gerät hin. Es macht auf einen Bedienungsablauf, eine Arbeitsweise oder eine sonstige Gegebenheit aufmerksam, deren unsachgemäße Ausführung bzw. ungenügende Berücksichtigung zu einer Beschädigung oder Zerstörung des Gerätes oder von Teilen des Gerätes führen kann.

---

**Hinweis**



---

Das Symbol **HINWEIS** macht auf wichtige Informationen bezüglich eines Arbeitsablaufs, einer Arbeitsweise, eines Zustands oder einer sonstige Gegebenheit aufmerksam.

---

## Erklärung der am Gerät angebrachten Symbole

Nachstehender Tabelle sind die Bedeutungen der Symbole zu entnehmen, die am Gerät angebracht sein können.















Bedeutung der am Gerät angebrachten Symbole			
			
Ein (Energie) IEC 417, No.5007	Aus (Energie) IEC 417, No.5008	Erdanschluß IEC 417, No.5017	Schutzleiteranschluß IEC 417, No.5019
			
Masseanschluß IEC 417, No.5020	Equipotential- anschluß IEC 417, No.5021	Gleichstrom IEC 417, No.5031	Wechselstrom IEC 417, No.5032
			
Gleich- oder Wechselstrom IEC 417, No.5033-a	Durchgängige doppelte oder verstärkte Isolierung IEC 417, No.5172-a	Dreileiter- Wechselstrom (Drehstrom) IEC 617-2, No.020206	
			
Warnung vor einer Gefahrenstelle (Achtung, Dokumen- tation beachten) ISO 3864, No.B.3.1	Warnung vor gefährlicher elektrischer Spannung ISO 3864, No.B.3.6	Höhere Temperatur an leicht zugänglichen Teilen IEC 417, No.5041	

Tabelle 2: Bedeutung der am Gerät angebrachten Symbole

## **Sicherheitsvorschriften und Vorsichtsmaßnahmen**

**Folgende allgemeine Sicherheitsvorschriften sind während allen Betriebsphasen dieses Gerätes zu befolgen. Eine Mißachtung der Sicherheitsvorschriften und sonstiger Warnhinweise in dieser Betriebsanleitung verletzt die für dieses Gerät und seine Bedienung geltenden Sicherheitsstandards, und kann die Schutzvorrichtungen an diesem Gerät wirkungslos machen. MKS Instruments, Inc. haftet nicht für Mißachtung dieser Sicherheitsvorschriften seitens des Kunden.**

### **Niemals Teile austauschen oder Änderungen am Gerät vornehmen!**

Ersetzen Sie keine Teile mit baugleichen oder ähnlichen Teilen, und nehmen Sie keine eigenmächtigen Änderungen am Gerät vor. Schicken Sie das Gerät zwecks Wartung und Reparatur an den MKS-Kalibrierungs- und -Kundendienst ein. Nur so wird sichergestellt, daß alle Schutzvorrichtungen voll funktionsfähig bleiben.

### **Wartung nur durch qualifizierte Fachleute!**

Das Auswechseln von Komponenten und das Vornehmen von internen Einstellungen darf nur von qualifizierten Fachleuten durchgeführt werden, niemals vom Bedienpersonal.

### **Vorsicht beim Arbeiten mit gefährlichen Stoffen!**

Wenn gefährliche Stoffe verwendet werden, muß der Bediener die entsprechenden Sicherheitsvorschriften genauestens einhalten, das Gerät, falls erforderlich, vollständig spülen, sowie sicherstellen, daß der Gefahrstoff die am Gerät verwendeten Materialien, insbesondere Dichtungen, nicht angreift.

### **Spülen des Gerätes mit Gas!**

Nach dem Installieren oder vor dem Ausbau aus einem System muß das Gerät unter Einsatz eines reinen Trockengases vollständig gespült werden, um alle Rückstände des Vorgängermediums zu entfernen.

### **Anweisungen zum Spülen des Gerätes**

Das Gerät darf nur unter einer Ablufthaube gespült werden. Schutzhandschuhe sind zu tragen.

### **Gerät nicht zusammen mit explosiven Stoffen, Gasen oder Dämpfen benutzen!**

Um der Gefahr einer Explosion vorzubeugen, darf dieses Gerät niemals zusammen mit (oder in der Nähe von) explosiven Stoffen aller Art eingesetzt werden, sofern es nicht ausdrücklich für diesen Zweck zugelassen ist.

**Anweisungen zum Installieren der Armaturen!**

Alle Anschlußstücke und Armaturenteile müssen mit der Gerätespezifikation übereinstimmen, und mit dem geplanten Einsatz des Gerätes kompatibel sein. Der Einbau, insbesondere das Anziehen und Abdichten, muß gemäß den Anweisungen des Herstellers vorgenommen werden.

**Verbindungen auf Undichtigkeiten prüfen!**

Überprüfen Sie sorgfältig alle Verbindungen der Vakuumkomponenten auf undichte Stellen.

**Gerät nur unter zulässigen Anschlußdrücken betreiben!**

Betreiben Sie das Gerät niemals unter Drücken, die den maximal zulässigen Druck (siehe Produktspezifikationen) übersteigen.

**Geeignete Berstscheibe installieren!**

Wenn mit einer unter Druck stehenden Gasquelle gearbeitet wird, sollte eine geeignete Berstscheibe in das Vakuumsystem installiert werden, um eine Explosionsgefahr aufgrund von steigendem Systemdruck zu vermeiden.

**Verunreinigungen im Gerät vermeiden!**

Stellen Sie sicher, daß Verunreinigungen jeglicher Art weder vor dem Einsatz noch während des Betriebs in das Instrumenteninnere gelangen können. Staub- und Schmutzpartikel, Glassplitter oder Metallspäne können das Gerät dauerhaft beschädigen oder Prozeß und Meßwerte verfälschen.

**Bei Geräten mit Temperaturkontrolle korrekte Anwärmzeit einhalten!**

Temperaturkontrollierte Geräte arbeiten nur dann gemäß ihrer Spezifikation, wenn genügend Zeit zum Erreichen und Stabilisieren der Betriebstemperatur eingeräumt wird. Kalibrierungen und Nulleinstellungen sollten daher nur nach Abschluß des Anwärmvorgangs durchgeführt werden.

## Informations relatives à la sécurité pour le transducteur de pression

### Symboles utilisés dans ce manuel d'utilisation

Définitions des indications AVERTISSEMENT, ATTENTION, et REMARQUE utilisées dans ce manuel.

#### Avertissement



---

L'indication **AVERTISSEMENT** signale un danger pour le personnel. Elle attire l'attention sur une procédure, une pratique, une condition, ou toute autre situation présentant un risque d'accident pour le personnel, en cas d'exécution incorrecte ou de non respect des consignes.

---

#### Attention



---

L'indication **ATTENTION** signale un danger pour l'appareil. Elle attire l'attention sur une procédure d'exploitation, une pratique, ou toute autre situation, présentant un risque d'endommagement ou de destruction d'une partie ou de la totalité de l'appareil, en cas d'exécution incorrecte ou de non respect des consignes.

---

#### Remarque



---

L'indication **REMARQUE** signale une information importante. Elle attire l'attention sur une procédure, une pratique, une condition, ou toute autre situation, présentant un intérêt particulier.

---



## Symboles apparaissant sur l'unité

Le tableau suivant décrit les symboles pouvant apparaître sur l'unité.

Définition des symboles apparaissant sur l'unité			
	○	⏏	⏏
Marche (sous tension) IEC 417, No.5007	Arrêt (hors tension) IEC 417, No.5008	Terre (masse) IEC 417, No.5017	Terre de protection (masse) IEC 417, No.5019
⏏	⏏	≡	~
Masse IEC 417, No.5020	Equipotentialité IEC 417, No.5021	Courant continu IEC 417, No.5031	Courant alternatif IEC 417, No.5032
⏏	□	3~	
Courant continu et alternatif IEC 417, No.5033-a	Matériel de classe II IEC 417, No.5172-a	Courant alternatif triphase IEC 617-2, No.020206	
⚠	⚡	⚠	
Attention : se reporter à la documentation ISO 3864, No.B.3.1	Attention : risque de choc électrique ISO 3864, No.B.3.6	Attention : surface brûlante IEC 417, No.5041	

Tableau 3: Définition des symboles apparaissant sur l'unité

## **Mesures de sécurité et précautions**

**Prendre les précautions générales de sécurité suivantes pendant toutes les phases d'exploitation de cet appareil. Le non respect des ces précautions ou des avertissements contenus dans ce manuel constitue une violation des normes de sécurité relatives à l'utilisation de l'appareil et peut diminuer la protection fournie par l'appareil. MKS Instruments, Inc. n'assume aucune responsabilité concernant le non respect des consignes par les clients.**

### **PAS DE SUBSTITUTION DE PIÈCES OU DE MODIFICATION DE L'APPAREIL**

Ne pas installer des pièces de substitution ou effectuer des modifications non autorisées sur l'appareil. Renvoyer l'appareil à un centre de service et de calibrage MKS pour tout dépannage ou réparation afin de garantir l'intégrité des dispositifs de sécurité.

### **DÉPANNAGE UNIQUEMENT PAR DU PERSONNEL QUALIFIÉ**

Le personnel d'exploitation ne doit pas essayer de remplacer des composants ou de faire des réglages internes. Tout dépannage doit être uniquement effectué par du personnel qualifié.

### **PRÉCAUTION EN CAS D'UTILISATION AVEC DES PRODUITS DANGEREUX**

Si des produits dangereux sont utilisés, l'utilisateur est responsable de la prise des mesures de précaution appropriées, de la purge complète de l'appareil quand cela est nécessaire, et de la garantie que les produits utilisés sont compatibles avec les composants de cet appareil, y compris les matériaux d'étanchéité.

### **PURGE DE L'APPAREIL**

Après l'installation de l'unité, ou avant son enlèvement d'un système, purger l'unité complètement avec un gaz propre et sec afin d'éliminer toute trace du produit de flux utilisé précédemment.

### **UTILISATION DES PROCÉDURES APPROPRIÉES POUR LA PURGE**

Cet appareil doit être purgé sous une hotte de ventilation, et il faut porter des gants de protection.

### **PAS D'EXPLOITATION DANS UN ENVIRONNEMENT EXPLOSIF**

Pour éviter toute explosion, ne pas utiliser cet appareil dans un environnement explosif, sauf en cas d'homologation spécifique pour une telle exploitation.

### **UTILISATION D'ÉQUIPEMENTS APPROPRIÉS ET PROCÉDURES DE SERRAGE**

Tous les équipements de l'appareil doivent être cohérents avec ses spécifications, et compatibles avec l'utilisation prévue de l'appareil. Assembler et serrer les équipements conformément aux directives du fabricant.

**VÉRIFICATION DE L'ÉTANCHÉITÉ DES CONNEXIONS**

Vérifier attentivement toutes les connexions des composants pour le vide afin de garantir l'étanchéité de l'installation.

**EXPLOITATION AVEC DES PRESSIONS D'ENTRÉE NON DANGEREUSES**

Ne jamais utiliser des pressions supérieures à la pression nominale maximum (se reporter aux spécifications de l'unité pour la pression maximum admissible).

**INSTALLATION D'UN DISQUE D'ÉCHAPPEMENT ADAPTÉ**

En cas d'exploitation avec une source de gaz pressurisé, installer un disque d'échappement adapté dans le système à vide, afin d'éviter une explosion du système en cas d'augmentation de la pression.

**MAINTIEN DE L'UNITÉ À L'ABRI DES CONTAMINATIONS**

Ne pas laisser des produits contaminants pénétrer dans l'unité avant ou pendant l'utilisation. Des produits contaminants tels que des poussières et des fragments de tissu, de glace et de métal peuvent endommager l'unité d'une manière permanente ou contaminer le processus.

**RESPECT DU TEMPS D'ÉCHAUFFEMENT APPROPRIÉ POUR LES UNITÉS À TEMPÉRATURE CONTRÔLÉE**

Les unités à température contrôlée atteignent leurs spécifications uniquement quand on leur laisse un temps suffisant pour atteindre d'une manière stable la température d'exploitation. Ne pas remettre à zéro ou calibrer l'unité tant que l'échauffement n'est pas terminé.

## Medidas de seguridad del transductor de presión

### Símbolos usados en este manual de instrucciones

Definiciones de los mensajes de advertencia, precaución y de las notas usados en el manual.

**Advertencia**



---

El símbolo de advertencia indica la posibilidad de que se produzcan daños personales. Pone de relieve un procedimiento, práctica, estado, etc. que en caso de no realizarse u observarse correctamente puede causar daños personales.

---

**Precaución**



---

El símbolo de precaución indica la posibilidad de producir daños al equipo. Pone de relieve un procedimiento operativo, práctica, estado, etc. que en caso de no realizarse u observarse correctamente puede causar daños o la destrucción total o parcial del equipo.

---

**Nota**



---

El símbolo de notas indica información de importancia. Este símbolo pone de relieve un procedimiento, práctica o condición cuyo conocimiento es esencial destacar.

---

## Símbolos hallados en la unidad

La tabla siguiente contiene los símbolos que puede hallar en la unidad.















Definición de los símbolos hallados en la unidad			
			
Encendido (alimentación eléctrica) IEC 417, N° 5007	Apagado (alimentación eléctrica) IEC 417, N° 5008	Puesta a tierra IEC 417, N° 5017	Protección a tierra IEC 417, N° 5019
			
Caja o chasis IEC 417, N° 5020	Equipotencialidad IEC 417, N° 5021	Corriente continua IEC 417, N° 5031	Corriente alterna IEC 417, N° 5032
			
Corriente continua y alterna IEC 417, N° 5033-a	Equipo de clase II IEC 417, N° 5172-a	Corriente alterna trifásica IEC 617-2, N° 020206	
			
Precaución. Consulte los documentos adjuntos ISO 3864, N° B.3.1	Precaución. Riesgo de descarga eléctrica ISO 3864, N° B.3.6	Precaución. Superficie caliente IEC 417, N° 5041	

Tabla 4: Definición de los símbolos hallados en la unidad

## **Procedimientos y precauciones de seguridad**

**Las precauciones generales de seguridad descritas a continuación deben observarse durante todas las etapas de funcionamiento del instrumento. La falta de cumplimiento de dichas precauciones o de las advertencias específicas a las que se hace referencia en el manual, constituye una violación de las normas de seguridad establecidas para el uso previsto del instrumento y podría anular la protección proporcionada por el equipo. Si el cliente no cumple dichas precauciones y advertencias, MKS Instruments, Inc. no asume responsabilidad legal alguna.**

### **NO UTILICE PIEZAS NO ORIGINALES O MODIFIQUE EL INSTRUMENTO**

No instale piezas que no sean originales ni modifique el instrumento sin autorización. Para asegurar el correcto funcionamiento de todos los dispositivos de seguridad, envíe el instrumento al Centro de servicio y calibración de MKS toda vez que sea necesario repararlo o efectuar tareas de mantenimiento.

### **LAS REPARACIONES DEBEN SER EFECTUADAS ÚNICAMENTE POR TÉCNICOS AUTORIZADOS**

Los operarios no deben intentar reemplazar los componentes o realizar tareas de ajuste en el interior del instrumento. Las tareas de mantenimiento o reparación deben ser realizadas únicamente por personal autorizado.

### **TENGA CUIDADO CUANDO TRABAJE CON MATERIALES TÓXICOS**

Cuando se utilicen materiales tóxicos, es responsabilidad de los operarios tomar las medidas de seguridad correspondientes, purgar totalmente el instrumento cuando sea necesario y comprobar que el material utilizado sea compatible con los materiales del instrumento e inclusive, con todos los materiales de sellado.

### **PURGUE EL INSTRUMENTO**

Una vez instalada la unidad o antes de retirarla del sistema, purgue completamente la unidad con gas limpio y seco para eliminar todo resto de la sustancia líquida empleada anteriormente.

### **USE PROCEDIMIENTOS ADECUADOS PARA REALIZAR LA PURGA**

El instrumento debe purgarse debajo de una campana de ventilación y deben utilizarse guantes protectores.

### **NO HAGA FUNCIONAR EL INSTRUMENTO EN AMBIENTES CON RIESGO DE EXPLOSIÓN**

Para evitar que se produzcan explosiones, no haga funcionar este instrumento en un ambiente con riesgo de explosiones, excepto cuando el mismo haya sido certificado específicamente para tal uso.

**USE ACCESORIOS ADECUADOS Y REALICE CORRECTAMENTE LOS PROCEDIMIENTOS DE AJUSTE**

Todos los accesorios del instrumento deben cumplir las especificaciones del mismo y ser compatibles con el uso que se debe dar al instrumento. Arme y ajuste los accesorios de acuerdo con las instrucciones del fabricante.

**COMPRUEBE QUE LAS CONEXIONES SEAN A PRUEBA DE FUGAS**

Inspeccione cuidadosamente las conexiones de los componentes de vacío para comprobar que hayan sido instalados a prueba de fugas.

**HAGA FUNCIONAR EL INSTRUMENTO CON PRESIONES DE ENTRADA SEGURAS**

No haga funcionar nunca el instrumento con presiones superiores a la máxima presión nominal (en las especificaciones del instrumento hallará la presión máxima permitida).

**INSTALE UNA CÁPSULA DE SEGURIDAD ADECUADA**

Cuando el instrumento funcione con una fuente de gas presurizado, instale una cápsula de seguridad adecuada en el sistema de vacío para evitar que se produzcan explosiones cuando suba la presión del sistema.

**MANTENGA LA UNIDAD LIBRE DE CONTAMINANTES**

No permita el ingreso de contaminantes en la unidad antes o durante su uso. Los productos contaminantes tales como polvo, suciedad, pelusa, lascas de vidrio o virutas de metal pueden dañar irreparablemente la unidad o contaminar el proceso.

**CALIENTE ADECUADAMENTE LAS UNIDADES CONTROLADAS POR MEDIO DE TEMPERATURA**

Las unidades controladas por medio de temperatura funcionarán de acuerdo con las especificaciones sólo cuando se las caliente durante el tiempo suficiente para permitir que lleguen y se estabilicen a la temperatura de operación indicada. No calibre la unidad y no la ponga en cero hasta que finalice el procedimiento de calentamiento.

## Chapter One: General Information

### Introduction

The MKS Baratron® Types D24D and D25D Dual Range Absolute Capacitance Manometers are part of the MKS family of general purpose pressure transducers that are RoHS (Restriction of Hazardous Substances) compliant. They feature the added capacity of providing two distinct measurement outputs to provide accurate, reliable, and repeatable pressure measurements. The D24D and D25D are available in full scale ranges of 10, 100 and 1000 Torr, with a customer specified second output, having either 2, 5, or 10 times lower full scale pressure output to provide proportionally higher sensitivity. The D24D and D25D operate with  $\pm 15$  VDC ( $\pm 5\%$ ) input at  $\leq 400$  or  $500$  mA, depending on the type, and provide two outputs of 0 to 10 VDC linear with pressure. The sensor exposes only Inconel® to the process, permitting use with corrosive or dirty gases. Measurements are independent of gas composition.

Using the latest single-sided, dual-electrode Inconel transducer design, coupled with a low impedance, fixed-frequency bridge signal conditioner, these instruments are capable of withstanding high overpressure conditions (45 psia) with minimal or no shifts in output over their range. The advanced bridge signal conditioning technology provides high accuracy and is extremely stable during operation.

Protection from RF interference and noisy electrical environments is increased by the use of a metal case, by internal design elements, and by the use of surge and ESD suppression networks and RFI filtering on all inputs and outputs. All units meet the electromagnetic testing required for the European CE Mark when used with an overall metal braided shielded cable, properly grounded at both ends.

The D25D transducer has an accuracy of 0.25% of reading and the D24D unit has an accuracy of 0.12% of reading.

These transducers are designed specifically to meet the needs of vacuum process systems where environmental and process conditions are particularly demanding. Temperature control of the transducer minimizes the effects of ambient or process temperature variations typically encountered in process line environments. The D24D unit controls the transducer temperature at  $45^\circ$  C, and the D25D unit controls the transducer temperature at  $100^\circ$  C, thereby minimizing contamination from the process and affording better performance with ambient temperature variations.

The two transducers feature two trip point relays, each separately adjustable from 0.1 to 100% of Full Scale, on first signal only. The dimensions of the instruments are identical, and each transducer has a 15-pin “D” connector. Both models are “drop-in” compatible with earlier MKS dual-range Baratrons such as the Types D24B and D25B.



## **How This Manual is Organized**

This manual is designed to provide instructions on how to set up, install, and operate a Type D24D or D25D unit.

**Before installing your Type D24D or D25D unit in a system and/or operating it, carefully read and familiarize yourself with all precautionary notes in the *Safety Messages and Procedures* section at the front of this manual. In addition, observe and obey all WARNING and CAUTION notes provided throughout the manual.**

Chapter One, *General Information*, (this chapter) introduces the product and describes the organization of the manual.

Chapter Two, *Installation*, explains the environmental requirements and describes how to mount the instrument in your system.

Chapter Three, *Overview*, gives a brief description of the instrument and its functionality.

Chapter Four, *Operation*, describes how to use the instrument and explains all the functions and features.

Chapter Five, *Maintenance and Troubleshooting*, lists any maintenance required to keep the instrument in good working condition, and provides a checklist for reference should the instrument malfunction.

Appendix A, *Product Specifications*, lists the specifications of the instrument.

Appendix B, *Model Code Explanation*, describes the instrument's ordering code.

## **Customer Support**

Standard maintenance and repair services are available at all of our regional MKS Calibration and Service Centers listed on the back cover. In addition, MKS accepts the instruments of other manufacturers for recalibration using the Primary and Transfer Standard calibration equipment located at all of our regional service centers. Should any difficulties arise in the use of your Type D24D or D25D instrument, or to obtain information about companion products MKS offers, contact any authorized MKS Calibration and Service Center. If it is necessary to return the instrument to MKS, please obtain an RMA Number (Return Material Authorization Number) from the MKS Calibration and Service Center before shipping. The RMA Number expedites handling and ensures proper servicing of your instrument.

Please refer to the inside of the manual's back cover for a list of MKS Calibration and Service Centers.

---

### **Warning**



**All returns to MKS Instruments must be free of harmful, corrosive, radioactive, or toxic materials.**

---



## Chapter Two: Installation

### How To Unpack the Type D24D or D25D Unit

MKS has carefully packed Type D24D or D25D unit so that it will reach you in perfect operating order. Upon receiving the unit, however, you should check for defects, cracks, broken connectors, etc., to be certain that damage has not occurred during shipment.

---

**Note**

Do *not* discard any packing materials until you have completed your inspection and are sure the unit arrived safely.

---

If you find any damage, notify your carrier and MKS immediately. If it is necessary to return the unit to MKS, obtain an RMA Number (Return Material Authorization Number) from the MKS Service Center before shipping. Please refer to the inside of the back cover of this manual for a list of MKS Calibration and Service Centers.

### Unpacking Checklist

#### *Standard Equipment:*

- Type D24D or D25D Unit
- Type D24D or D25D Instruction Manual (this book)

#### *Optional Equipment:*

- Most MKS Pressure, Flow, Flow Ratio, and Throttling Valve Controllers
- Most MKS Power Supply/Readouts
- RM-6 Rack Mount Kit  
(for mounting one or two readouts and/or controllers in a 19" rack)
- Interface Cables (refer to Table 2, page 8)
- Electrical Connector Accessories Kit: D24/D25-KI (includes the mating connector for 15-pin I/O connector).

## Interface Cables

*As of July 20, 2009, most products shipped to the European Community must comply with the EMC Directive 2004/108/EEC, which covers radio frequency emissions and immunity tests. In addition, as of January 1, 1997, some products shipped to the European Community must also comply with the Product Safety Directive 92/59/EEC and Low Voltage Directive 73/23/EEC, which cover general safety practices for design and workmanship. MKS products that meet these requirements are identified by application of the CE Mark.*

To ensure compliance with EMC Directive 2004/108/EEC, an overall metal braided shielded cable, properly grounded at both ends, is required during use. No additional installation requirements are necessary to ensure compliance with Directives 92/59/EEC and 73/23/EEC.

### Note



An overall metal braided, shielded cable, properly grounded at both ends, is required during use to meet CE specifications.

Purchase interface cables to all MKS companion products from MKS, or optionally, you can make cables that meet the appropriate cable specifications.

For cables that will be connected to non-MKS products, MKS can provide normal shielding or braided shielded cable assemblies in a nominal 10' (3m) length, terminating in *flying leads* (pigtail) fashion at both ends. MKS recommends braided shielded cable assemblies if the environment contains high EMI/RFI noise.

MKS D24/D25 Interface Cables		
To Connect D24/D25 with 15-pin D Connector to...	Use Cable Number...	
	Standard	Shielded
PDR-D-1, PDR-D-2, PDR-5B	N/A	CBD24S-1-M1

To Connect D24/D25 with terminal block adapter to...	Use Cable Number...	
	Standard	Shielded
PDR-D-1, PDR-D2, PDR-5B	CB473-1-10	CB473S-1-10
146, 186, 651, PR4000	CB112-2-10	CB112S-2-10

Table 5: Interface Cables

## Generic Shielded Cables

Should you choose to manufacture your own cables, follow the guidelines listed below:

1. The cable must have an overall metal *braided* shield, covering all wires. Neither aluminum foil nor spiral shielding will be as effective; using either may nullify regulatory compliance.
2. The connectors must have a metal case which has direct contact to the cable's shield on the whole circumference of the cable. The inductance of a flying lead or wire from the shield to the connector will seriously degrade the shield's effectiveness. The shield should be grounded to the connector before its internal wires exit.
3. With very few exceptions, the connector(s) must make good contact to the device's case (ground). "Good contact" is about 0.01 ohms; and the ground should surround all wires. Contact to ground at just one point may not suffice.
4. For shielded cables with flying leads at one or both ends; it is important at each such end, to ground the shield *before* the wires exit. Make this ground with absolute minimum length. Refer to Figures 1 and 2, page 30. (A ¼ inch piece of #22 wire may be undesirably long since it has approximately 5 nH of inductance, equivalent to 31 ohms at 1000 MHz). After picking up the braid's ground, keep wires and braid flat against the case. With very few exceptions, grounded metal covers are not required over terminal strips. If one is required, it will be stated in the Declaration of Conformity or in the instruction manual.
5. In selecting the appropriate type and wire size for cables, consider:
  - A. The voltage ratings.
  - B. The cumulative  $I^2R$  heating of all the conductors (keep them safely cool).
  - C. The IR drop of the conductors, so that adequate power or signal voltage gets to the device.
  - D. The capacitance and inductance of cables which are handling fast signals, (such as data lines or stepper motor drive cables).
  - E. That some cables may need internal shielding from specific wires to others; please see the instruction manual for details regarding this matter.

**Example 1: Preferred Method To Connect Cable**  
 (shown on a transducer)

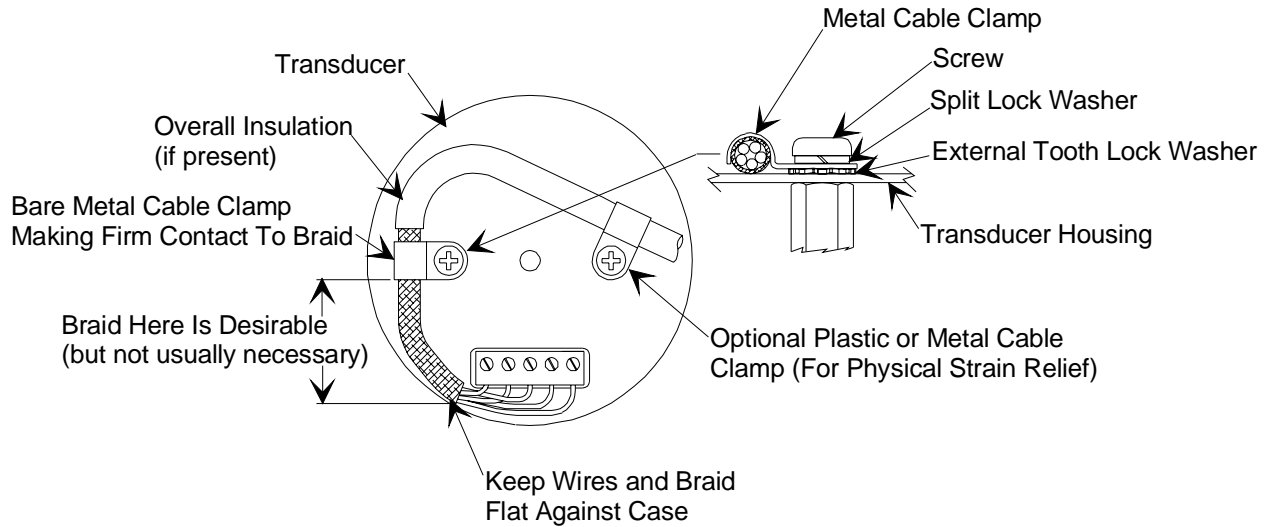

Figure 1: Preferred Method To Connect an Overall Metal Braided Shielded Cable

**Example 2: Alternate Method To Connect Cable**  
 (shown on a transducer)

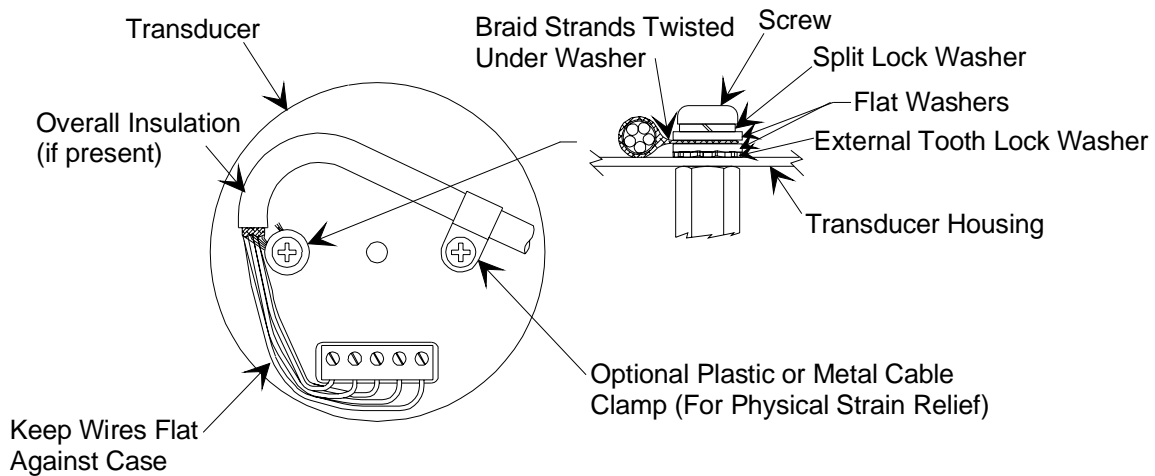

Figure 2: Alternate Method To Connect an Overall Metal Braided Shielded Cable  
 Use this method when cable clamp is not available

## **Product Location and Requirements**

### ***Type D24D Absolute Pressure Transducer (Heated):***

- Ambient operating temperature should remain between 15° and 40° C (59° to 104° F)
- Input required is  $\pm 15$  VDC ( $\pm 5\%$ ) @ 400 mA (maximum) with <20 mV p-p noise and ripple
- Sensor operating temperature: temperature controlled @ 45° C

### ***Type D25D Absolute Pressure Transducer (High Temperature):***

- Ambient operating temperature should remain between 15° and 50° C (59° to 122° F)
- Input required is  $\pm 15$  VDC ( $\pm 5\%$ ) @ 500 mA (maximum) with <20 mV p-p noise and ripple
- Sensor operating temperature: temperature controlled @ 100° C

For additional product requirements refer to *Appendix A: Product Specifications*, page 53.

## **Fittings**

The transducer port will easily carry the weight of the transducer. The following is a list of available fittings.

- ½" diameter (12.7 mm) tubulation
- Swagelok® 8-VCR®, female
- Mini-CF, rotatable
- NW16-KF
- NW25-KF

## Setup

### Dimensions

#### Note



All dimensions are listed in inches with millimeters referenced in parentheses.

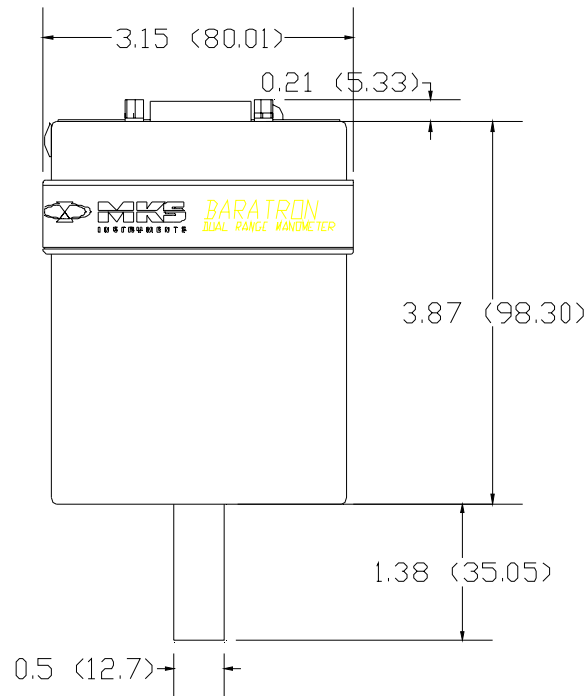

Figure 3: Dimensions of the D24 and D25 Transducers

### Mounting Instructions

Mount the transducer in the recommended orientation, that is, with the inlet port pointing (vertically) downward. Although you can mount the unit in any orientation, mounting it as suggested means that any foreign matter entering the pressure port will fall away from the diaphragm.

Isolate the unit from vibration as much as possible. When not subject to gas damping at low pressure, the diaphragm may become susceptible to resonance.



## **Electrical Information**

The D24D and D25D transducers each require an external power source capable of supplying the voltages listed in Table 3. Noise and ripple should be less than 20 mV p-p. Any readout device that has input capabilities of less than 0 to greater than 10 VDC and impedance greater than 10k ohms can be used.

### **Note**



The ground of any external power supply and readout should be the same as the transducer ground (chassis ground) to minimize any possible ground loops that can affect the performance and stability of the system.

<b>Required Inputs for the D24D and D25D Transducers</b>		
<b>Input Required</b>	<b>Type D24D</b>	<b>Type D25D</b>
At Startup	±15 VDC (±5%) @ 400 mA	±15 VDC (±5%) @ 500 mA
After 1 hour of operation at 25°C	±15 VDC (±5%) @ 300 mA	±15 VDC (±5%) @ 500 mA

Table 6: Required Inputs for the D24D and D25D Transducers

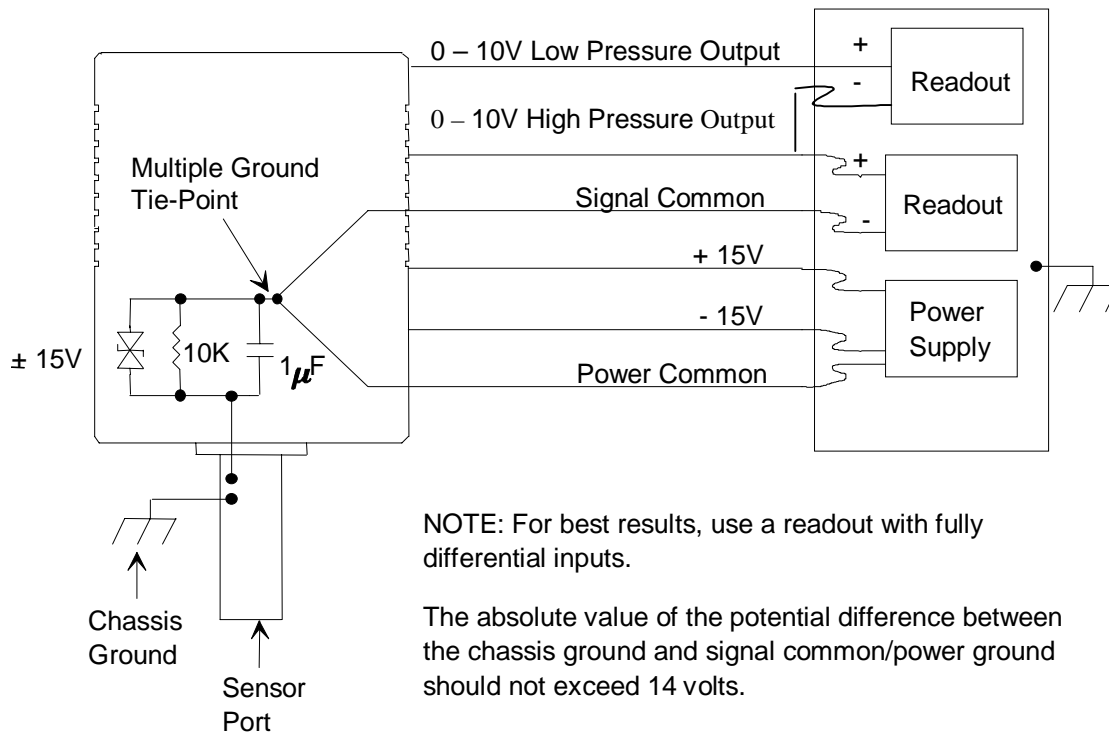

Figure 4: Power, Signal, and Chassis Grounding Scheme

## Interface Connectors

The standard interface connector on the top of the D24D and D25D is a 15-pin “D” style connector that provides input power, the analog output, and relay contacts. The pinout is shown in Table 4 on page 16. The connector is available in thread locks or slide locks.

The optional terminal block adapter pinout is also available. The adapter plugs into the standard 15-pin D style connector and is fastened to the connector with thread lock screws. This pinout is shown in Table 5 on page 17.

### *Thread Locks*

The 15-pin connector with thread locks utilizes threaded posts onto which the mating connector is mechanically fastened using screws. This is the standard MKS “D” style connector.

### *Slide Locks*

The 15-pin with slide locks utilizes slotted posts onto which the mating connector is mechanically fastened using a slide mechanism, which engages the slotted posts.

---

**Note**



Standard MKS interface cables are not available with slide locks.

---

### 15-Pin Interface Connector Pinout

Below is Table 4 that displays the 15-pin “D” interface connector pinout.

<b>15-Pin “D” Style Interface Connector Pinout</b>	
<b>Pin Number</b>	<b>Signal</b>
1	Trip Point-A Voltage Level
2	High Pressure Signal Output (1 <sup>st</sup> Pressure Output)
3	Trip Point-A N.C.
4	Trip Point-A N.O.
5	Power Return (Power Common)
6	-15 VDC
7	+15 VDC
8	Trip Point-A Common
9	Trip Point-B N.O.
10	Trip Point-B N.C.
11	Trip Point-B Common
12	Pressure Output Return (Signal Common)
13	Trip Point-B Voltage Level
14	Low Pressure Range Output (2 <sup>nd</sup> Pressure Output)
15	Chassis Ground

Table 7: 15-Pin “D” Style Interface Connector Pinout

### Terminal Block Adapter Pinout

Below is the Table 5 that displays the optional terminal block adapter pinout.

<b>Terminal Block Adapter Pinout (TB1)</b>	
<b>Pin Number</b>	<b>Signal</b>
1	Trip Point-A Voltage Level
2	High Range Signal Output (1 <sup>st</sup> Pressure Output)
3	Trip Point-A N.C.
4	Trip Point-A N.O.
5	Power Return (Power Common)
6	-15VDC
7	+15VDC
8	Trip Point-A Common
9	Trip Point-B N.O.
10	Trip Point-B N.C.
11	No Connection
12	Signal Return (Signal Common)
13	Trip Point-B Voltage Level
14	Low Pressure Range Output (2 <sup>nd</sup> Pressure Output)
15	Chassis Ground
16	Chassis Ground

Table 8: Terminal Block Adapter Pinout

## **Startup**

After installation, allow your transducer to warm up until it is stabilized, then check the transducer zero to verify the proper output. Refer to *How To Adjust the Zero*, page 44, for complete instructions on adjusting the ZERO potentiometer.

The transducer should be powered and allowed to warm up before using its pressure measurements. The warm up time is usually 2 to 4 hours for the D24D and D25D units

---

**Note**

The transducer must be fully stabilized before you make any adjustments to the ZERO potentiometer.

---

---

**Caution**

**Only qualified persons should perform the installation and any adjustments. They must comply with all relevant ESD and handling precautions while installing and adjusting the instrument. Proper handling is essential when working with highly sensitive, precision electronic instruments.**

---

## Chapter Three: Overview

### General Information

A complete pressure transducer system requires three components to convert pressure to a linear DC voltage output: a sensor, signal conditioner, and power supply. An analog or digital meter is required to display the DC output in pressure units.

MKS Type D24D and D25D transducers contain two of the above components: the sensor and signal conditioner. A MKS or user-supplied power supply is required to complete the pressure to DC voltage output conversion, and a MKS or user-supplied display unit is required for direct pressure readout.

### Sensor

The variable capacitance sensor consists of a pressure inlet tube (port) connected to a small chamber in the transducer body. One wall of this chamber is an elastic metal diaphragm. The front side of the diaphragm is exposed to the gas whose pressure is to be measured. The back, or *reference* side of the diaphragm faces a rigidly mounted ceramic disc containing two electrodes. The reference side is permanently evacuated ( $10^{-7}$  Torr) and its vacuum is maintained with a chemical getter system.

The diaphragm deflects with changing absolute pressure (force per unit area) independently of the gas type or composition of the measured gas. This deflection causes an imbalance of the sensor electrode capacitances since the distance to the diaphragm is now different for each electrode. The imbalance of capacitances is converted to a DC voltage in the bridge. This bridge is excited by a precision constant frequency oscillator. The resultant signal is then linearized, zeroed, and amplified via the signal conditioner electronics, to produce a precise 0 to 10 VDC signal scaled to the range of the transducer.

In the heated models (Types D24D and D25D), zero and span stability is further increased because the sensor and bridge electronics are temperature controlled. This thermal enclosure reduces the effects of ambient temperature changes by a factor of at least 35 (that is a 35° C change in ambient temperature will produce less than a 1° C change inside the thermal housing).

### Signal Conditioner/Electronics

The signal conditioner contains a state-of-the-art, low impedance balanced bridge circuitry, self-compensated for thermal stability with ambient temperature changes. Output is a DC voltage, which is linear with pressure. The transducer is then calibrated against a pressure standard to provide a 0 to 10 Volt DC output over the range of the transducer for the full scale range. A second output is provided over a range in ratio to the full scale range.

## The Endcap

Figure 5 shows the endcaps of a D24 and D25 transducers.

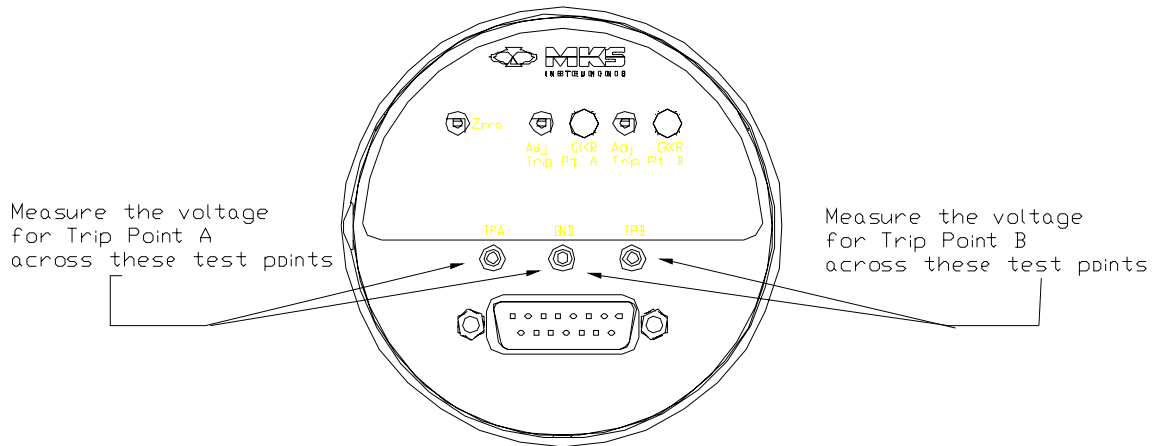

Figure 5: The Endcap

The endcap provides access to the 15-pin D connector, the zero adjustments, the test points, and the trip point adjustment pots for setting the trip points. The LEDs illuminate to indicate when the transducer is powered and to indicate the status of the pressure relative to each of the trip points. A green LED indicates the pressure is *below* the alarm trip point and a red LED indicates the pressure is *above* the alarm trip point.

## Hysteresis

Hysteresis is built into the operation of the two trip points to help compensate for the noise inherent in all systems. Without hysteresis, the noise may cause the relays to repeatedly switch states, a condition known as “relay chatter.” Each trip point has a separate hysteresis setting.

Setting the hysteresis too high creates a *deadband* around the trip point. The deadband prevents the trip point relay from responding to changes in the pressure signal around the trip point. Ideally, the hysteresis should be close to, but not less than, the peak-to-peak noise to provide maximum immunity from relay chatter while providing the best possible accuracy. It may take some trial and error efforts to determine the best hysteresis setting for your system.

Figure 6, page 41, shows a system in which the relay is energized when the pressure falls *below* the trip point setting.



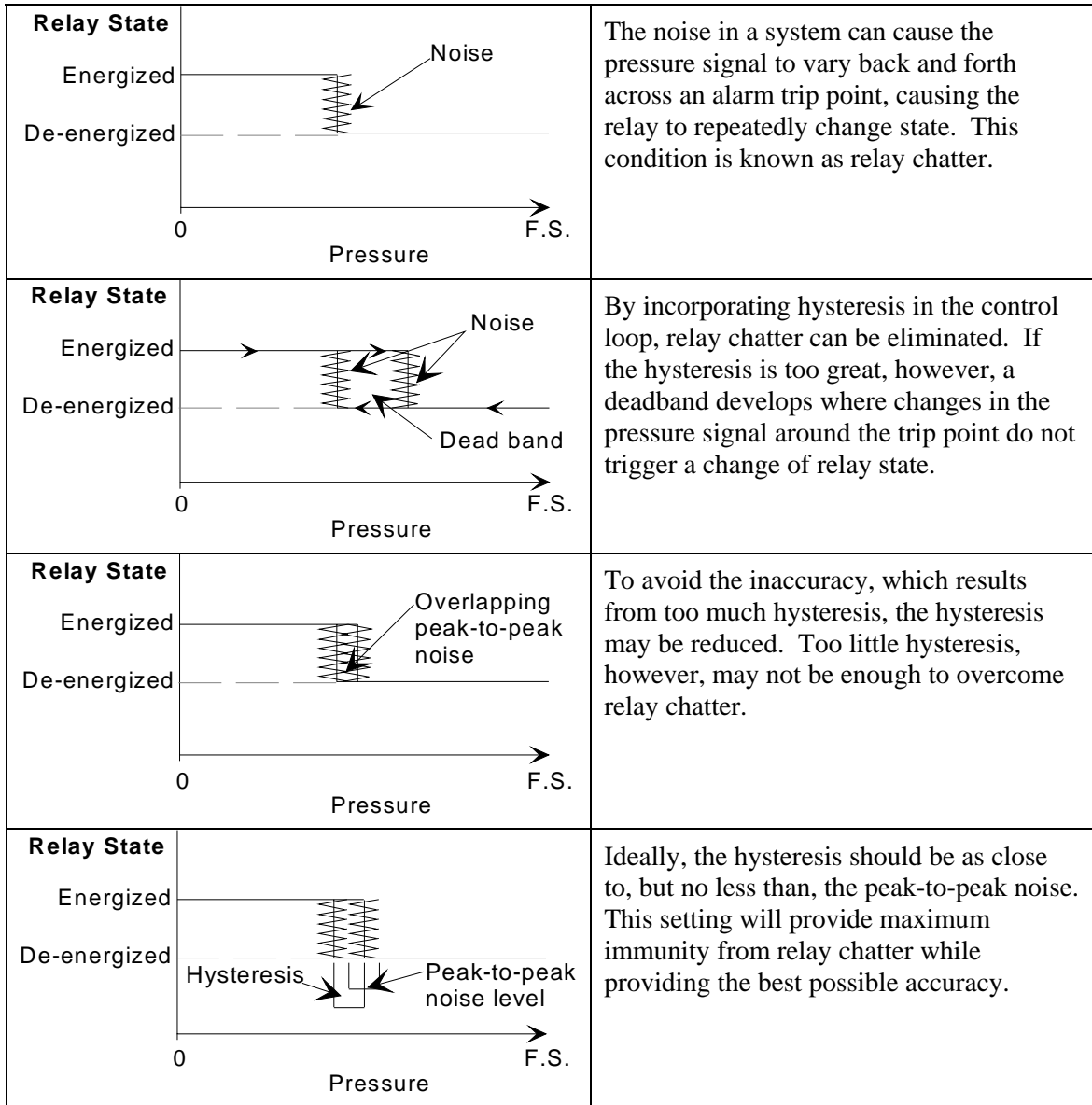

Figure 6: How Hysteresis Effects Accuracy and Relay Chatter

## Label

The serial number label, located on the transducer body, lists the unit's serial number, model number, input power requirements, and full scale range. The label also displays the CE mark, signifying compliance with the European CE regulations.

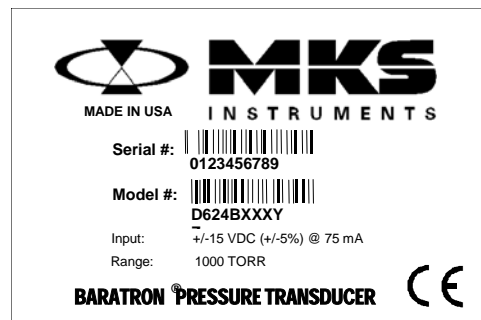

Figure 7: Serial Number Label

The options for your transducer are identified in the model code when you order the unit. Refer to Appendix B: Model Code Explanation, page 37 for more information.

## Chapter Four: Operation

### General Information

All pressure transducers require initial and periodic zero adjustments. Prior to initial operation and during periodic maintenance you must check the transducer zero to verify the proper output. The zero can be set (or reset) by adjusting the ZERO potentiometer, located on the transducer's endcap (refer to Figure 8, page 25). The transducer should be powered and allowed to warm up before using its pressure measurements.

#### Lowest Suggested Pressures for Reading and Control

Suggested Pressures for Reading and Control		
Full Scale Range (Torr)	Lowest Suggested Pressure for Reading (Torr)	Lowest Suggested Pressure for Control (Torr)
10	$5 \times 10^{-3}$	$5 \times 10^{-2}$
100	$5 \times 10^{-2}$	$5 \times 10^{-1}$
1K	$5 \times 10^{-1}$	$5 \times 10^0$

Table 9: Suggested Pressures for Reading and Control

#### *Lowest Suggested Pressure Available for Reading*

The pressures listed in the middle column of Table 6 reflect reliable and practical pressures for different range transducers. Lower readings may be obtained in environments, which have stable temperature and air flow.

#### *Lowest Suggested Pressure to Use for Control*

The pressures listed in the last column of Table 6 are for reference, and represent the pressure reading of the transducer at a 50 mV signal output. A DC signal of at least 50 mV is the recommended minimum signal level to use when integrating any transducer into complex processing systems.

## How To Adjust the Zero

To achieve the full dynamic range specified for the transducer, the zero adjustment *must* be made at a pressure lower than the transducer's minimum resolution (0.01% of FS). Zeroing a transducer above its stated minimum resolution creates a *zero offset* relative to true absolute pressure. All subsequent readings are then linear and accurate *relative to the offset value*.

### Note



If available pressures are not sufficiently low to set the transducer to zero, you may use a vacuum leak detector with sufficient vacuum pumping (to achieve proper zeroing pressures). In this case, mount the transducer on the leak detector *in the same plane of orientation as it will be during actual use*.

To properly zero the D24D or D25D transducer:

1. Install the transducer in a system with a power supply/readout.
2. Power the transducer and allow it to warm up and stabilize.

### Note



Warm up times are usually 2 to 4 hours for the D24D and D25D units. Ensure that the transducer is *fully stabilized* before you adjust the zero.

3. Pump the unit down to a pressure below its resolution (0.01% of FS).

For best results, pump the transducer while it is warming up. Refer to Table 7 for the highest recommended pressure levels for proper zero adjustment.

<b>Highest Pressure Suggested for Proper Zero Adjustment</b>	
<b>Full Scale Range (Torr)</b>	<b>Highest Pressure for Proper Zero Adjustment (Torr)</b>
10	$< 1 \times 10^{-3}$
100	$< 1 \times 10^{-2}$
1K	$< 1 \times 10^{-1}$

Table 10: Highest Pressure Suggested for Proper Zero Adjustment

4. Adjust the ZERO pot with a small flathead screwdriver until the readout displays zero (0000).

The ZERO pot is located on the unit's endcap (refer to Figure 8, page 25.).

## How To Set the Trip Points

There are two trip points, labeled Trip Point A and Trip Point B, each with its own trip point adjustment. These trip points apply to the first signal output only. The voltage of Trip Point A can be measured with a voltmeter across Test Point A (TPA) and (GND). The voltage of Trip Point B can be measured across Test Point B (TPB) and (GND).

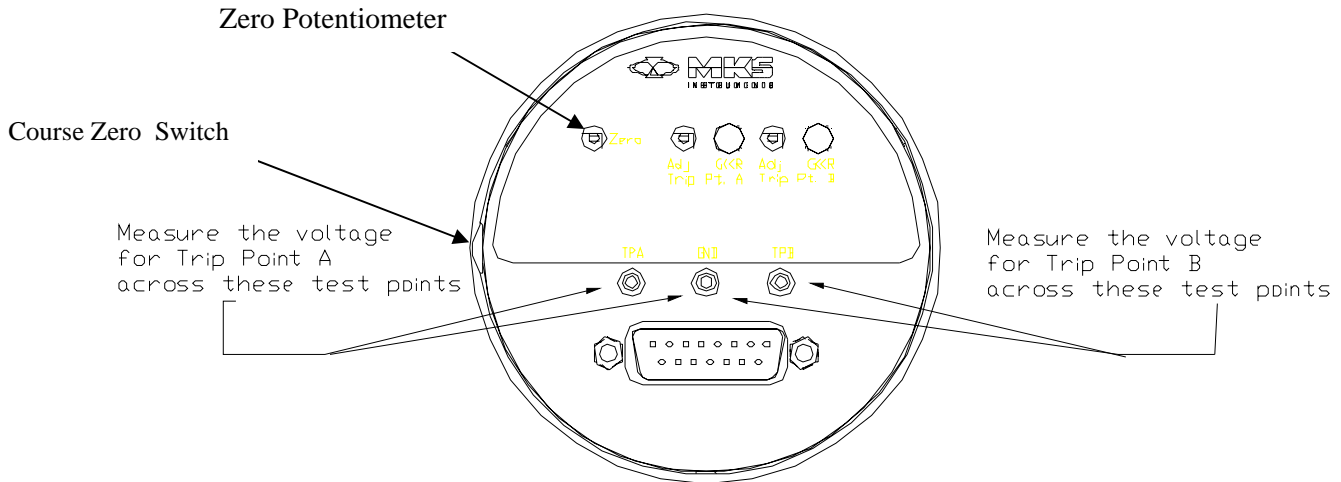

Figure 8: How To Measure the Trip Point Voltage

To adjust a trip point, connect a voltmeter as described above for the appropriate trip point and adjust the corresponding adjustment potentiometer until the voltage displayed on the voltmeter equals the pressure output signal at the desired trip point level.

For example, if you are working with a full scale range of 100 Torr and it requires a trip point at 2 Torr, adjust the appropriate potentiometer until the voltage level reads 0.200 VDC ( $10 \text{ VDC} \div 100 \text{ Torr} = 0.100 \text{ Volts/Torr}$ ).

### Note



Due to hysteresis, the actual relay trip point pressure may be slightly higher than the pressure for which the trip point was set. The difference between the *set* trip point pressure and the *actual* trip point pressure will vary depending upon the degree of hysteresis you have selected.

Refer to *Hysteresis*, page 40, and *How To Adjust the Trip Point Hysteresis*, page 49, for more information.

## **How To Adjust the Trip Point Direction**

The trip point direction defines the direction of pressure change that will energize the trip point. The trip point direction for the D24D and D25D transducers is initially set “low”; the trip points are energized as the pressure falls *below* the specified trip point level. The trip point direction can be changed to “high”; so that the trip points energize as the pressure rises *above* their respective trip points.

To change the trip point direction, do the following:

1. Turn off the power to the transducer and disconnect the cable by unplugging the 15-pin D connector.
2. Remove the two hex posts/lock washers from the 15-pin D connector.
3. Remove the label from the transducer. This exposes a number of flat head Phillips screws around the band.
4. Remove the screws from the top of the band and gently lift off the top can assembly.

The Relay Board with jumpers J12, J13, J15, and J16 is now accessible. The Relay Board is shown in Figure 9, page 27.

5. Move the shorting jumpers on Jumpers J13 and J16 to change the configuration of Trip Point A and move the shorting jumpers on Jumpers J12 and J15 to change the configuration of the Trip Point B.

Refer to Table 5 for the factory-set positions of the shorting jumpers.

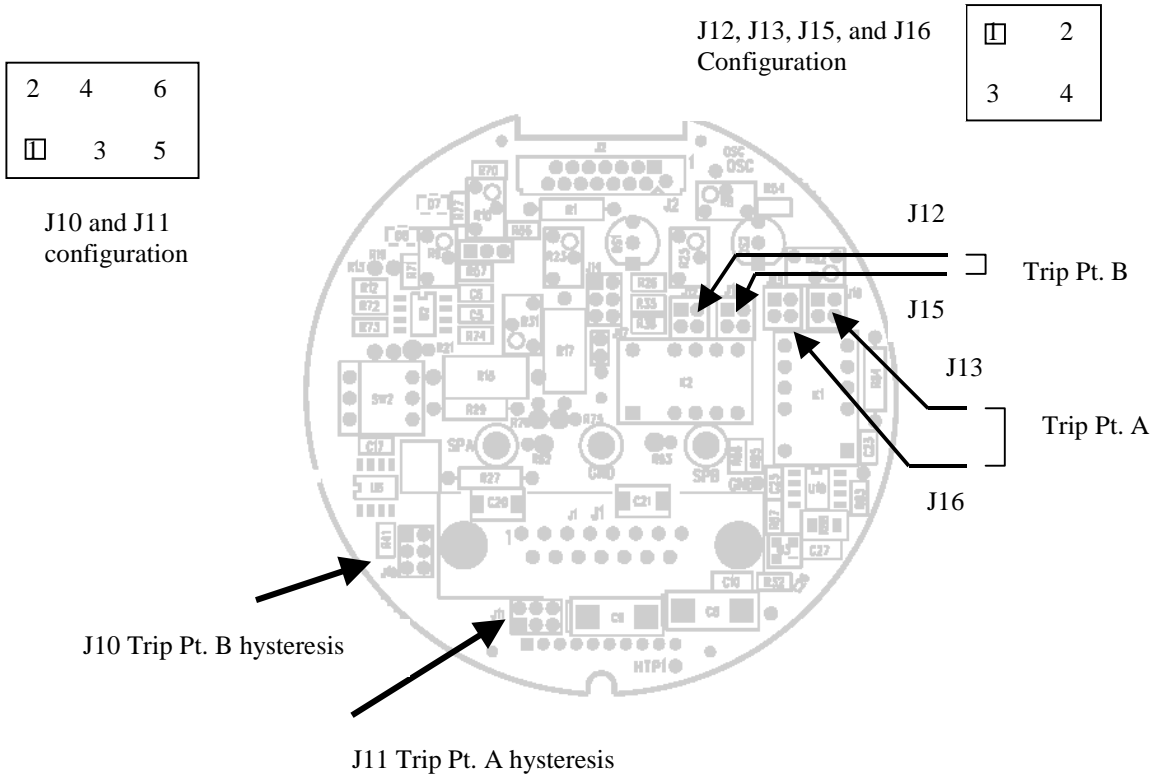

Figure 9: The Relay Board

Factory-Set Positions of the Shorting Jumpers		
Trip Point	Energized <i>Below</i> Trip Point	Energized <i>Above</i> Trip Point
<b>Trip Point A</b>	J13: 1-3, 2-4 J16: 1-3, 2-4	J13: 1-2, 3-4 J16: 1-2, 3-4
<b>Trip Point B</b>	J12: 1-3, 2-4 J15: 1-3, 2-4	J12: 1-2, 3-4 J15: 1-2, 3-4

Table 11: Factory-Set Positions of the Shorting Jumpers

6. Replace the top enclosure, carefully aligning the D connector in the hole.
7. Re-install the two hex posts/lock washers securing the D connector to the top enclosure.
8. Replace the three flat head screws in the black joiner to secure the top enclosure.
9. Replace the label around the joiner.
10. Reconnect the cable to the 15-pin D connector.
11. Turn power back on to the transducer.

**Note**

---

The trip points are automatically de-energized when the unit is without power. To use either the open or closed contacts on the relay, make the appropriate connections on this connector.

---



## **How To Adjust the Trip Point Hysteresis**

Hysteresis is built into the operation of the two trip relays to help compensate for the noise inherent in all systems. Without hysteresis, the noise may cause the alarm relays to chatter (repeatedly switch states). On the Relay board in the Type D24D and D25D units, are jumpers J11 (for Trip Point A) and J10 (for Trip Point B). You can adjust the amount of hysteresis separately for each alarm relay by placing shorting jumpers on J11 and J10.

Refer to *Hysteresis*, page 40, for an explanation of the effect of different amounts of hysteresis.

To change the transducer's configuration:

1. Turn off power to the unit and disconnect the cable.
2. Remove the two hex posts/lock washers from either side of the electrical connector.
3. Remove the band label from around the joiner. This will expose six Phillips head screws around the joiner.
4. Remove the top three flat head screws and gently lift off the top enclosure. This will expose the relay board with the jumper being accessible.
5. Move the shorting jumpers on jumper J11 to change the hysteresis of Trip Point A and move the shorting jumpers on jumper J10 to change the hysteresis of Trip Point B.

Refer to Table 9 for the correct shorting jumper positions.

<b>Shorting Jumper Positions for Hysteresis</b>		
<b>Hysteresis (% of FS)</b>	<b>Trip Point A</b>	<b>Trip Point B</b>
0.1%	J11: 2-4	J10: 2-4
0.2%	J11: 4-6	J10: 4-6
0.5% <i>Factory-set position</i>	J11: 1-3	J10: 1-3
1%	J11: 3-5	J10: 3-5
2%	J11: 3-4	J10: 3-4

Table 12: Shorting Jumper Positions for Hysteresis

6. Replace the top enclosure, carefully aligning the D connector in the hole.
7. Install the two hex posts/lock washers to secure the D connector to the enclosure.
8. Replace the three flat head screws in the black joiner to secure the top enclosure.
9. Replace the label round the joiner.
10. Reconnect the cable to the 15-pin D connector.
11. Turn on the power to the transducer.

## Chapter Five: Maintenance and Troubleshooting

### General Information

If your transducer fails to operate properly upon receipt, check for shipping damage, and check the power/signal cable for proper continuity. Any damage should be reported to the carrier and MKS Instruments immediately. If there is no obvious damage and the continuity is correct, obtain an ERA Number (Equipment Return Authorization Number) before returning the unit to MKS Instruments for service.

**Note**

---

MKS recommends that the zero adjustment be the only adjustment made in the field. Return the transducer to MKS Instruments for other adjustments, calibrations, or servicing.

---

### Maintenance

In general, no maintenance is required other than proper installation and operation, and an occasional zero adjustment. Periodically check for wear on the cables and inspect the enclosure for visible signs of damage.

#### **Zero Adjustment**

The transducer zero can be set (or reset) by adjusting the ZERO potentiometer located on the transducer's endcap, or at the front panel of any MKS Power Supply/Readout being used. Refer to *How To Adjust the Zero*, page 44, for complete instructions on how to adjust the transducer zero.

**Note**

---

In production operations such as semiconductor manufacturing, verify the transducer zero (and adjust if necessary) each time the equipment is turned on after routine maintenance.

---

#### **How To Clean the Unit**

Periodically wipe down the unit with a damp cloth.

**Troubleshooting**

<b>Troubleshooting Chart</b>		
<b>Symptom</b>	<b>Possible Cause</b>	<b>Remedy</b>
Overrange positive or negative signal	A shorted transducer or a damaged interconnect cable (transducer to electronics module)	Measure supply voltages at the connector. Inspect cable and transducer and replace if necessary.
Measurement slowly goes positive over time	Overpressure and/or a build-up of contamination in the Px cavity	Return to MKS for servicing or transducer replacement.
Unstable zero output	The ambient temperature may be too high  or The ambient temperature is varying over a wide range	Check the ambient temperature value in <i>Appendix A: Product Specifications</i> , page 53, and be sure the ambient temperature is within product requirements.

Table 13: Troubleshooting Chart

## Appendix A: Product Specifications

### Type D24D Transducer

Accuracy (including non-linearity, hysteresis, and non-repeatability)	± 0.12% of Reading
Ambient operating temperature range <i>Sensor operating temperature is ambient</i>	15° to 40° C (59° to 104° F)
CE Compliance <sup>1</sup>	EMC Directive 2004/108/EEC
RoHS (Restriction of Hazardous Substances) Compliance	Fully compliant to 2002-95-EC
Fittings Standard Optional	½" diameter (12.7 mm) tubulation Swagelok® 8-VCR® (female), Mini-CF (rotatable), NW-16-KF, Swagelok 8-VCO® (female)
Full Scale Pressure ranges (mmHg)	10, 100, 1000
Input power required	±15 VDC (±5%) @ 400 mA (max)
Materials exposed to gases	Inconel®
Output	0 to 10 VDC into ≥ 10k ohm load full scale range 0 to 10 VDC over the reduced range
Overpressure limit without damage	45 psia (310 kPa)
Temperature Coefficients Zero Span	0.002% FS / ° C 0.02% Reading / ° C
Time constant	< 20 msec
Trip points (First Signal Output Only)	Two process trip point relays, each adjustable from 0.1% to 100% of FS, SPDT contacts rated at 1 A @ 30 VDC or 0.5 A @ 30 VAC resistive 0 to 10 VDC output proportional to each trip point, 12.5K ohm maximum source impedance Relays: G6G-234C-24VDC
Useable measurement range	1 x 10 <sup>-4</sup> FS

<sup>1</sup>An overall metal braided shielded cable, properly grounded at both ends, is required during use.

Volume (Px side)	6.3 cc
------------------	--------

### **Type D25D Transducer**

Accuracy (including non-linearity, hysteresis, and non-repeatability)	± 0.25% of Reading
Ambient operating temperature range <i>Sensor operating temperature is 100°C</i>	15° to 50° C (59° to 122° F)
CE Compliance <sup>2</sup>	EMC Directive 2004/108/EEC
RoHS (Restriction of Hazardous Substances) Compliance	Fully compliant to 2002-95-EC
Fittings Standard Optional	½" diameter (12.7 mm) tubulation Swagelok® 8-VCR® (female), Mini-CF (rotatable), NW16-KF, Swagelok 8-VCO® (female)
Full Scale Pressure ranges (mmHg)	10, 100, 1000
Input power required	±15 VDC (±5%) @ 500 mA
Materials exposed to gases	Inconel
Overpressure limit without damage	45 psia (310 kPa)
Output	0 to 10 VDC into ≥ 10k ohm load FS range 0 to 10 VDC over the ratioed range
Temperature Coefficients Zero Span	0.002% FS / ° C 0.02% Reading / ° C
Time constant	< 20 msec

<sup>2</sup>An overall metal braided shielded cable, properly grounded at both ends, is required during use.

Trip points (First Signal Output Only)	Two process trip point relays, each adjustable from 0.1% to 100% of FS on first signal output only, SPDT contacts rated at 1 A @ 30 VDC or 0.5 A @ 30 VAC resistive  0 to 10 VDC output proportional to each set point, 12.5K ohm maximum source impedance  Relays: G6G-234C-24VDC
Useable measurement range	1 x 10 <sup>-4</sup> FS
Volume (Px side)	6.3 cc

Due to continuing research and development activities, these specifications are subject to change without notice.





## Appendix B: Model Code Explanation

### Model Code

The options of your unit are identified in the model code. The model code is identified as follows:

**#### XXX Y Z C R**

<b>Model Code</b>	
Type Number	####
Full Scale Range	XXX
Fittings	Y
Accuracy	Z
Connector	C
Ratio	R

#### **Type Number (####)**

This designates the model number of the instrument, either D24D or D25D.

#### **Full Scale Range (XXX)**

The full scale range in Torr is indicated by a two digit/one letter code.

<b><i>Full Scale Range (mmHg)</i></b>	<b><i>Ordering Code</i></b>
10	11T
100	12T
1000	13T

**Fittings (Y)**

The choice of fittings is designated by a two letter code.

<i>Fittings</i>	<i>Ordering Code</i>
½" diameter (12.7 mm) tubulation	BA
Swagelok® 8-VCR® (female)	CE
Mini-CF (rotatable)	HA
NW-16-KF	GA
NW-25-KF	GC

**Accuracy (Z)**

The accuracy specification is designated by a single letter code.

<i>Accuracy</i>	<i>Ordering Code</i>
±0.12% of Reading (standard D24 unit)	C
±0.25% of Reading (standard D25 unit)	E

**Connector (C)**

The two configurations of the 15-pin Type "D" connector are available, designated by a single letter code.

<i>Connectors (C)</i>	<i>Ordering Code</i>
15-pin male "D" w/thread locks	B
15-pin male "D" w/slide locks	P
15-position terminal block adapter	U

**Ratio**

The ratio specification is designated by a single digit code.

<i>Ratio</i>	<i>Ordering Code</i>
2 to 1	2
5 to 1	5
10 to 1	0

Index

	<b>A</b>		<b>P</b>
Accuracy, 24		Power requirements, 33	Pressure, lowest for reading and control, 43
	<b>C</b>		<b>R</b>
Cables		Returning the product, 25, 27	RoHS (Restriction of Hazardous Substances), 24, 53, 54
generic shielded, 29			
interface, 28			
CE mark, 24, 28			
Customer support, 25			
	<b>E</b>		<b>S</b>
Endcap, 40		Safety information, 8–23	Sensor, description of, 39
	<b>F</b>	Serial number label, 42	Specifications, 53–55
Fittings, 31		Startup, 38	
	<b>H</b>		<b>T</b>
Hysteresis		Transducers, overview, 24, 39	Trip points
description of, 40–41			hysteresis, 49
trippoint, 49			jumper direction, 46
	<b>I</b>		pot adjustment, 46
Input power, 33			voltage, 45
	<b>M</b>		Troubleshooting, 52
Maintenance, 51			
Manual organization, 25			<b>W</b>
Mounting instructions, 32		Warm up times, 44	Warm up times, 38
			<b>Z</b>
		Zero adjustment, 44, 51	Zero offset, 44