



# **MKS Baratron®**

## **Types 740C, 742C, 750C, 752C, R740C, and R750C Pressure Transducers**

### **Instruction Manual**

2 Technology Drive  
Andover, MA, USA 01810

Main: 978.645.5500  
USA: 800.227.8766  
[www.mksinst.com](http://www.mksinst.com)

1034255-001  
Revision B, 3/13  
Instruction Manual



## WARRANTY

Types 740C, 742C, 750C, 752C, R740C, and R750C Equipment

MKS Instruments, Inc. (**MKS**) warrants that for two years from the date of shipment the equipment described above (the "equipment") manufactured by **MKS** shall be free from defects in materials and workmanship and will correctly perform all date-related operations, including without limitation accepting data entry, sequencing, sorting, comparing, and reporting, regardless of the date the operation is performed or the date involved in the operation, provided that, if the equipment exchanges data or is otherwise used with equipment, software, or other products of others, such products of others themselves correctly perform all date-related operations and store and transmit dates and date-related data in a format compatible with **MKS** equipment. THIS WARRANTY IS **MKS'** SOLE WARRANTY CONCERNING DATE-RELATED OPERATIONS.

For the period commencing with the date of shipment of this equipment and ending two years later, **MKS** will, at its option, either repair or replace any part which is defective in materials or workmanship or with respect to the date-related operations warranty without charge to the purchaser. The foregoing shall constitute the exclusive and sole remedy of the purchaser for any breach by **MKS** of this warranty.

The purchaser, before returning any equipment covered by this warranty, which is asserted to be defective by the purchaser, shall make specific written arrangements with respect to the responsibility for shipping the equipment and handling any other incidental charges with the **MKS** sales representative or distributor from which the equipment was purchased or, in the case of a direct purchase from **MKS**, with the **MKS** home office in Andover, Massachusetts, USA.

This warranty does not apply to any equipment which has not been installed and used in accordance with the specifications recommended by **MKS** for the proper and normal use of the equipment. **MKS** shall not be liable under any circumstances for indirect, special, consequential, or incidental damages in connection with, or arising out of, the sale, performance, or use of the equipment covered by this warranty.

**MKS** recommends that all **MKS** pressure and flow products be calibrated periodically (typically every 6 to 12 months) to ensure accurate readings. When a product is returned to **MKS** for this periodic re-calibration it is considered normal preventative maintenance not covered by any warranty.

THIS WARRANTY IS IN LIEU OF ALL OTHER RELEVANT WARRANTIES, EXPRESSED OR IMPLIED, INCLUDING THE IMPLIED WARRANTY OF MERCHANTABILITY AND THE IMPLIED WARRANTY OF FITNESS FOR A PARTICULAR PURPOSE, AND ANY WARRANTY AGAINST INFRINGEMENT OF ANY PATENT.

## SPECIAL NOTICE

This warranty is void if the product is installed using single or double metal ferrule compression type vacuum fittings, shown below. These fittings are commonly tightened incorrectly, causing damage to the pressure sensor.

Single Ferrule

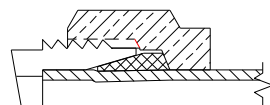

Double Ferrule

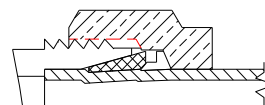

# **MKS Type 740C/750C/742C/752C Baratron® Pressure Transducers and R7xxC Series Relay Systems**

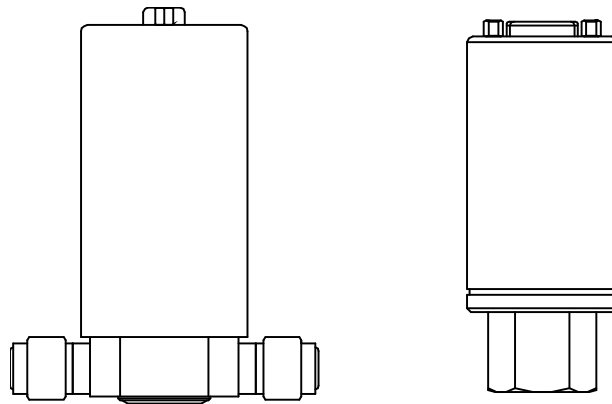

*Copyright © 2013 by MKS Instruments, Inc.*

*All rights reserved. No part of this work may be reproduced or transmitted in any form or by any means, electronic or mechanical, including photocopying and recording, or by any information storage or retrieval system, except as may be expressly permitted in writing by MKS Instruments, Inc.*

*Printed in the United States of America*

Baratron® is a registered trademark of MKS Instruments, Inc., Andover, MA, USA.

Swagelok®, VCR®, and VCO® are registered trademarks of Swagelok Company, Solon, OH, USA.

Bendix® is a registered trademark of Amphenol Corp., Bendix Connector Operations, Sidney, NY, USA.

Inconel® and Incoloy® are registered trademarks of Inco Alloys International, Inc., Huntington, WV, USA.

*Some Baratron® products may not be exported to many end user countries without both US and local government export licenses under ECCN 2B230.*

## Table of Contents

Pressure Transducer Safety Information .....	1
Symbols Used in This Instruction Manual.....	1
Symbols Found on the Unit .....	2
Safety Procedures and Precautions .....	3
Sicherheitshinweise für den Druckmeßumformer .....	5
In dieser Betriebsanleitung vorkommende Symbole .....	5
Erklärung der am Gerät angebrachten Symbole .....	6
Sicherheitsvorschriften und Vorsichtsmaßnahmen.....	7
Informations relatives à la sécurité pour le transducteur de pression .....	9
Symboles utilisés dans ce manuel d'utilisation .....	9
Symboles apparaissant sur l'unité .....	10
Mesures de sécurité et précautions .....	11
Medidas de seguridad del transductor de presión .....	13
Símbolos usados en este manual de instrucciones .....	13
Símbolos hallados en la unidad.....	14
Procedimientos y precauciones de seguridad .....	15
Chapter One: General Information .....	17
Introduction.....	17
How This Manual is Organized .....	18
Customer Support .....	19
Chapter Two: Installation .....	21
How To Unpack the 7xxC Series Unit .....	21
Unpacking Checklist.....	21
Product Location and Requirements.....	22
Interface Cables .....	23
Generic Shielded Cable Description .....	24
Setup .....	26
Mounting the Unit.....	26
Fittings .....	28

Making Welded Connections.....	29
Making Mechanical Connections .....	29
Electrical Information for a Current Unit .....	30
Electrical Information for a Voltage Unit.....	32
Connectors .....	33
Dimensions .....	37
Single Ended Version .....	37
Flow-Through Version .....	38
How To Connect to a Type PDR Series Readout .....	39
Type “D” Connector (either 9-pin or 15-pin High Density).....	39
Bendix Connector (option 1 pinout) .....	40
How To Check the Transducer Zero.....	41
How To Zero an Absolute Transducer.....	42
How To Zero a Gage Unit .....	43
Span Adjustment.....	44
Chapter Three: Overview.....	46
General.....	46
Sensor.....	46
Signal Conditioning Electronics .....	47
Chapter Four: Operation .....	49
General.....	49
Lowest Suggested Pressure Available for Reading .....	49
Lowest Suggested Pressure to Use for Control.....	49
Chapter Five: Type R7xxC Relay System .....	51
General Information.....	51
Initial Settings.....	51
Trip Point Parameters .....	52
Setup .....	54
Cabling.....	54
Dimensions .....	55
Mounting Instructions.....	57
Electrical Information .....	59
Connector.....	59

---

Electrical Requirements .....	59
Contact Rating .....	60
How To Configure the Trip Points .....	60
Chapter Six: Maintenance and Troubleshooting.....	63
General.....	63
Zero Adjustment .....	63
Troubleshooting.....	64
Appendix A: Product Specifications.....	65
700 Series Specifications .....	65
General Description .....	67
Product Type.....	67
Full Scale Range and Engineering Units .....	68
Fittings .....	69
Input/Output Settings.....	70
Accuracy .....	70
Connector.....	71
Index .....	73





---

## List of Figures

Figure 1: Preferred Method.....	25
Figure 2: Alternate Method To Use When Cable Clamp is Not Available .....	25
Figure 3: Acceptable Vertical Mounting Positions.....	26
Figure 4: <i>Unacceptable</i> Vertical Mounting Positions (units < 20 psi full scale).....	27
Figure 5: Acceptable Horizontal Mounting Positions.....	27
Figure 6: Line Resistance Equation .....	30
Figure 7: Total Resistance in Line .....	30
Figure 8: Electrical Scheme for the 4 to 20 mA Unit .....	31
Figure 9: Electrical Scheme for a Voltage Unit.....	32
Figure 10: Dimensional Drawing of the Single-Ended Design .....	37
Figure 11: Dimensional Drawing of the Flow-Through Design.....	38
Figure 12: Top Cover.....	41
Figure 13: Location of the Trip Point Adjustment Pots .....	52
Figure 14: Trip Point Direction Set Low .....	53
Figure 15: Trip Point Direction Set High.....	53
Figure 16: Dimensions of the Relay Module .....	55
Figure 17: Top View of the Type R7xxC Unit .....	56
Figure 18: Side View of the Type R7xxC Unit .....	56
Figure 19: Location of the Trip Point Adjustments .....	57
Figure 20: Screws on the Top of the Transducer .....	58
Figure 21: Relay Module PC Board.....	61



## List of Tables

Table 1: Definition of Symbols Found on the Unit .....	2
Tabelle 2: Bedeutung der am Gerät angebrachten Symbole .....	6
Tableau 3: Définition des symboles apparaissant sur l'unité .....	10
Tabla 4: Definición de los símbolos hallados en la unidad.....	14
Table 5: The 7xxC Series Model Selection Guide.....	17
Table 6: Interface Cables .....	23
Table 7: Fittings Available.....	28
Table 8: 9-Pin Type “D” Connector Pinout.....	34
Table 9: 15-Pin High Density Type “D” Connector Pinout.....	34
Table 10: Bendix 4 Position PTO Connector Option 1 Pinout .....	35
Table 11: Bendix 4 Position PTO Connector Option 2 Pinout .....	35
Table 12: Flying Leads (Model Code F) Pinout .....	36
Table 13: Flying Leads (Model Code L) Pinout .....	36
Table 14: Dimensions for Connectors and Fittings for Single-Ended Units.....	37
Table 15: Dimensions for Connectors and Fittings for Flow-Through Units.....	38
Table 16: Connections Between PDR Readout and a Transducer (Type “D” Connector) .....	39
Table 17: Connections Between a PDR Readout and a Transducer (Bendix Connector) .....	40
Table 18: Highest Pressure for Proper Zero Adjustment .....	43
Table 19: Output of a Compound Gage Unit at 0 psig .....	44
Table 20: Suggested Pressures for Reading and Control .....	49
Table 21: Initial Settings for the Relay System .....	51
Table 22: Type R7xxC Connector Pinout.....	59
Table 23: Troubleshooting Chart .....	64
Table 24: Full Scale Range Ordering Code .....	68
Table 25: Engineering Units Ordering Code .....	68
Table 26: Examples of Full Scale and Engineering Unit Ordering Codes.....	69
Table 27: Ordering Code for Fittings.....	69
Table 28: Input/Output Selection Ordering Code .....	70
Table 29: Accuracy Ordering Code .....	70
Table 30: Connector Ordering Code.....	71



## Pressure Transducer Safety Information

### Symbols Used in This Instruction Manual

Definitions of WARNING, CAUTION, and NOTE messages used throughout the manual.

---

**Warning**  The **WARNING** sign denotes a hazard to personnel. It calls attention to a procedure, practice, condition, or the like, which, if not correctly performed or adhered to, could result in injury to personnel.

---

---

**Caution**  The **CAUTION** sign denotes a hazard to equipment. It calls attention to an operating procedure, practice, or the like, which, if not correctly performed or adhered to, could result in damage to or destruction of all or part of the product.

---

---

**Note**  The **NOTE** sign denotes important information. It calls attention to a procedure, practice, condition, or the like, which is essential to highlight.

---

## Symbols Found on the Unit

The following table describes symbols that may be found on the unit.























Definition of Symbols Found on the Unit			
  Off (Supply) IEC 417, No.5008	 Off (Supply) IEC 417, No.5008	  Protective earth (ground) IEC 417, No.5019	 Protective earth (ground) IEC 417, No.5019
    Alternating current IEC 417, No.5032	  Alternating current IEC 417, No.5032	  Alternating current IEC 417, No.5032	 Alternating current IEC 417, No.5032
 Both direct and alternating current IEC 417, No.5033-a	  Three phase alternating current IEC 617-2 No.020206	 Three phase alternating current IEC 617-2 No.020206	
 Caution, refer to accompanying documents ISO 3864, No.B.3.1	 Caution, risk of electric shock ISO 3864, No.B.3.6	 Caution, hot surface IEC 417, No.5041	

Table 1: Definition of Symbols Found on the Unit

## **Safety Procedures and Precautions**

**Observe the following general safety precautions during all phases of operation of this instrument. Failure to comply with these precautions or with specific warnings elsewhere in this manual violates safety standards of intended use of the instrument and may impair the protection provided by the equipment. MKS Instruments, Inc. assumes no liability for the customer's failure to comply with these requirements.**

### **DO NOT SUBSTITUTE PARTS OR MODIFY INSTRUMENT**

Do not install substitute parts or perform any unauthorized modification to the instrument. Return the instrument to an MKS Calibration and Service Center for service and repair to ensure that all safety features are maintained.

### **SERVICE BY QUALIFIED PERSONNEL ONLY**

Operating personnel must not attempt component replacement and internal adjustments. Any service must be made by qualified service personnel only.

### **USE CAUTION WHEN OPERATING WITH HAZARDOUS MATERIALS**

If hazardous materials are used, users must take responsibility to observe the proper safety precautions, completely purge the instrument when necessary, and ensure that the material used is compatible with the materials in this product, including any sealing materials.

### **PURGE THE INSTRUMENT**

After installing the unit, or before removing it from a system, purge the unit completely with a clean, dry gas to eliminate all traces of the previously used flow material.

### **USE PROPER PROCEDURES WHEN PURGING**

This instrument must be purged under a ventilation hood, and gloves must be worn for protection.

### **DO NOT OPERATE IN AN EXPLOSIVE ENVIRONMENT**

To avoid explosion, do not operate this product in an explosive environment unless it has been specifically certified for such operation.

### **USE PROPER FITTINGS AND TIGHTENING PROCEDURES**

All instrument fittings must be consistent with instrument specifications, and compatible with the intended use of the instrument. Assemble and tighten fittings according to manufacturer's directions.

**CHECK FOR LEAK-TIGHT FITTINGS**

Carefully check all vacuum component connections to ensure leak-tight installation.

**OPERATE AT SAFE INLET PRESSURES**

Never operate at pressures higher than the rated maximum pressure (refer to the product specifications for the maximum allowable pressure).

**INSTALL A SUITABLE BURST DISC**

When operating from a pressurized gas source, install a suitable burst disc in the vacuum system to prevent system explosion should the system pressure rise.

**KEEP THE UNIT FREE OF CONTAMINANTS**

Do not allow contaminants to enter the unit before or during use. Contamination such as dust, dirt, lint, glass chips, and metal chips may permanently damage the unit or contaminate the process.

**ALLOW PROPER WARM UP TIME FOR TEMPERATURE-CONTROLLED UNITS**

Temperature-controlled units will only meet specifications when sufficient time is allowed for the unit to meet, and stabilize at, the designed operating temperature. Do not zero or calibrate the unit until the warm up is complete.



# Sicherheitshinweise für den Druckmeßumformer

## In dieser Betriebsanleitung vorkommende Symbole

Bedeutung der mit WARNUNG!, VORSICHT! und HINWEIS gekennzeichneten Absätze in dieser Betriebsanleitung.

### Warnung!



---

Das Symbol **WARNUNG!** weist auf eine Gefahr für das Bedienpersonal hin. Es macht auf einen Arbeitsablauf, eine Arbeitsweise, einen Zustand oder eine sonstige Gegebenheit aufmerksam, deren unsachgemäße Ausführung bzw. ungenügende Berücksichtigung zu Verletzungen führen kann.

---

### Vorsicht!



---

Das Symbol **VORSICHT!** weist auf eine Gefahr für das Gerät hin. Es macht auf einen Bedienungsablauf, eine Arbeitsweise oder eine sonstige Gegebenheit aufmerksam, deren unsachgemäße Ausführung bzw. ungenügende Berücksichtigung zu einer Beschädigung oder Zerstörung des Gerätes oder von Teilen des Gerätes führen kann.

---

### Hinweis



---

Das Symbol **HINWEIS** macht auf wichtige Informationen bezüglich eines Arbeitsablaufs, einer Arbeitsweise, eines Zustands oder einer sonstige Gegebenheit aufmerksam.

---

## Erklärung der am Gerät angebrachten Symbole

Nachstehender Tabelle sind die Bedeutungen der Symbole zu entnehmen, die am Gerät angebracht sein können.















Bedeutung der am Gerät angebrachten Symbole			
			
Ein (Energie) IEC 417, No.5007	Aus (Energie) IEC 417, No.5008	Erdanschluß IEC 417, No.5017	Schutzleiteranschluß IEC 417, No.5019
			
Masseanschluß IEC 417, No.5020	Aquipotential- anschluß IEC 417, No.5021	Gleichstrom IEC 417, No.5031	Wechselstrom IEC 417, No.5032
			
Gleich- oder Wechselstrom IEC 417, No.5033-a	Durchgängige doppelte oder verstärkte Isolierung IEC 417, No.5172-a	Dreileiter- Wechselstrom (Drehstrom) IEC 617-2, No.020206	
			
Warnung vor einer Gefahrenstelle (Achtung, Dokumen- tation beachten) ISO 3864, No.B.3.1	Warnung vor gefährlicher elektrischer Spannung ISO 3864, No.B.3.6	Höhere Temperatur an leicht zugänglichen Teilen IEC 417, No.5041	

Tabelle 2: Bedeutung der am Gerät angebrachten Symbole

## **Sicherheitsvorschriften und Vorsichtsmaßnahmen**

**Folgende allgemeine Sicherheitsvorschriften sind während allen Betriebsphasen dieses Gerätes zu befolgen. Eine Mißachtung der Sicherheitsvorschriften und sonstiger Warnhinweise in dieser Betriebsanleitung verletzt die für dieses Gerät und seine Bedienung geltenden Sicherheitsstandards, und kann die Schutzvorrichtungen an diesem Gerät wirkungslos machen. MKS Instruments, Inc. haftet nicht für Mißachtung dieser Sicherheitsvorschriften seitens des Kunden.**

### **Niemals Teile austauschen oder Änderungen am Gerät vornehmen!**

Ersetzen Sie keine Teile mit baugleichen oder ähnlichen Teilen, und nehmen Sie keine eigenmächtigen Änderungen am Gerät vor. Schicken Sie das Gerät zwecks Wartung und Reparatur an den MKS-Kalibrierungs- und -Kundendienst ein. Nur so wird sichergestellt, daß alle Schutzvorrichtungen voll funktionsfähig bleiben.

### **Wartung nur durch qualifizierte Fachleute!**

Das Auswechseln von Komponenten und das Vornehmen von internen Einstellungen darf nur von qualifizierten Fachleuten durchgeführt werden, niemals vom Bedienpersonal.

### **Vorsicht beim Arbeiten mit gefährlichen Stoffen!**

Wenn gefährliche Stoffe verwendet werden, muß der Bediener die entsprechenden Sicherheitsvorschriften genauestens einhalten, das Gerät, falls erforderlich, vollständig spülen, sowie sicherstellen, daß der Gefahrstoff die am Gerät verwendeten Materialien, insbesondere Dichtungen, nicht angreift.

### **Spülen des Gerätes mit Gas!**

Nach dem Installieren oder vor dem Ausbau aus einem System muß das Gerät unter Einsatz eines reinen Trockengases vollständig gespült werden, um alle Rückstände des Vorgängermediums zu entfernen.

### **Anweisungen zum Spülen des Gerätes**

Das Gerät darf nur unter einer Ablufthaube gespült werden. Schutzhandschuhe sind zu tragen.

### **Gerät nicht zusammen mit explosiven Stoffen, Gasen oder Dämpfen benutzen!**

Um der Gefahr einer Explosion vorzubeugen, darf dieses Gerät niemals zusammen mit (oder in der Nähe von) explosiven Stoffen aller Art eingesetzt werden, sofern es nicht ausdrücklich für diesen Zweck zugelassen ist.

**Anweisungen zum Installieren der Armaturen!**

Alle Anschlußstücke und Armaturenteile müssen mit der Gerätespezifikation übereinstimmen, und mit dem geplanten Einsatz des Gerätes kompatibel sein. Der Einbau, insbesondere das Anziehen und Abdichten, muß gemäß den Anweisungen des Herstellers vorgenommen werden.

**Verbindungen auf Undichtigkeiten prüfen!**

Überprüfen Sie sorgfältig alle Verbindungen der Vakuumkomponenten auf undichte Stellen.

**Gerät nur unter zulässigen Anschlußdrücken betreiben!**

Betreiben Sie das Gerät niemals unter Drücken, die den maximal zulässigen Druck (siehe Produktspezifikationen) übersteigen.

**Geeignete Berstscheibe installieren!**

Wenn mit einer unter Druck stehenden Gasquelle gearbeitet wird, sollte eine geeignete Berstscheibe in das Vakuumsystem installiert werden, um eine Explosionsgefahr aufgrund von steigendem Systemdruck zu vermeiden.

**Verunreinigungen im Gerät vermeiden!**

Stellen Sie sicher, daß Verunreinigungen jeglicher Art weder vor dem Einsatz noch während des Betriebs in das Instrumenteninnere gelangen können. Staub- und Schmutzpartikel, Glassplitter oder Metallspäne können das Gerät dauerhaft beschädigen oder Prozeß und Meßwerte verfälschen.

**Bei Geräten mit Temperaturkontrolle korrekte Anwärmzeit einhalten!**

Temperaturkontrollierte Geräte arbeiten nur dann gemäß ihrer Spezifikation, wenn genügend Zeit zum Erreichen und Stabilisieren der Betriebstemperatur eingeräumt wird. Kalibrierungen und Nulleinstellungen sollten daher nur nach Abschluß des Anwärmvorgangs durchgeführt werden.

## Informations relatives à la sécurité pour le transducteur de pression

### Symboles utilisés dans ce manuel d'utilisation

Définitions des indications AVERTISSEMENT, ATTENTION, et REMARQUE utilisées dans ce manuel.

---

#### Avertissement



L'indication **AVERTISSEMENT** signale un danger pour le personnel. Elle attire l'attention sur une procédure, une pratique, une condition, ou toute autre situation présentant un risque d'accident pour le personnel, en cas d'exécution incorrecte ou de non respect des consignes.

---

#### Attention



L'indication **ATTENTION** signale un danger pour l'appareil. Elle attire l'attention sur une procédure d'exploitation, une pratique, ou toute autre situation, présentant un risque d'endommagement ou de destruction d'une partie ou de la totalité de l'appareil, en cas d'exécution incorrecte ou de non respect des consignes.

---

#### Remarque



L'indication **REMARQUE** signale une information importante. Elle attire l'attention sur une procédure, une pratique, une condition, ou toute autre situation, présentant un intérêt particulier.

---

**Symboles apparaissant sur l'unité**

Le tableau suivant décrit les symboles pouvant apparaître sur l'unité.















Définition des symboles apparaissant sur l'unité			
			
Marche (sous tension) IEC 417, No.5007	Arrêt (hors tension) IEC 417, No.5008	Terre (masse) IEC 417, No.5017	Terre de protection (masse) IEC 417, No.5019
			
Masse IEC 417, No.5020	Equipotentialité IEC 417, No.5021	Courant continu IEC 417, No.5031	Courant alternatif IEC 417, No.5032
			
Courant continu et alternatif IEC 417, No.5033-a	Matériel de classe II IEC 417, No.5172-a	Courant alternatif triphasé IEC 617-2, No.020206	
			
Attention : se reporter à la documentation ISO 3864, No.B.3.1	Attention : risque de choc électrique ISO 3864, No.B.3.6	Attention : surface brûlante IEC 417, No.5041	

Tableau 3: Définition des symboles apparaissant sur l'unité

## **Mesures de sécurité et précautions**

**Prendre les précautions générales de sécurité suivantes pendant toutes les phases d'exploitation de cet appareil. Le non respect de ces précautions ou des avertissements contenus dans ce manuel constitue une violation des normes de sécurité relatives à l'utilisation de l'appareil et peut diminuer la protection fournie par l'appareil. MKS Instruments, Inc. n'assume aucune responsabilité concernant le non respect des consignes par les clients.**

### **PAS DE SUBSTITUTION DE PIÈCES OU DE MODIFICATION DE L'APPAREIL**

Ne pas installer des pièces de substitution ou effectuer des modifications non autorisées sur l'appareil. Renvoyer l'appareil à un centre de service et de calibrage MKS pour tout dépannage ou réparation afin de garantir l'intégrité des dispositifs de sécurité.

### **DÉPANNAGE UNIQUEMENT PAR DU PERSONNEL QUALIFIÉ**

Le personnel d'exploitation ne doit pas essayer de remplacer des composants ou de faire des réglages internes. Tout dépannage doit être uniquement effectué par du personnel qualifié.

### **PRÉCAUTION EN CAS D'UTILISATION AVEC DES PRODUITS DANGEREUX**

Si des produits dangereux sont utilisés, l'utilisateur est responsable de la prise des mesures de précaution appropriées, de la purge complète de l'appareil quand cela est nécessaire, et de la garantie que les produits utilisés sont compatibles avec les composants de cet appareil, y compris les matériaux d'étanchéité.

### **PURGE DE L'APPAREIL**

Après l'installation de l'unité, ou avant son enlèvement d'un système, purger l'unité complètement avec un gaz propre et sec afin d'éliminer toute trace du produit de flux utilisé précédemment.

### **UTILISATION DES PROCÉDURES APPROPRIÉES POUR LA PURGE**

Cet appareil doit être purgé sous une hotte de ventilation, et il faut porter des gants de protection.

### **PAS D'EXPLOITATION DANS UN ENVIRONNEMENT EXPLOSIF**

Pour éviter toute explosion, ne pas utiliser cet appareil dans un environnement explosif, sauf en cas d'homologation spécifique pour une telle exploitation.

### **UTILISATION D'ÉQUIPEMENTS APPROPRIÉS ET PROCÉDURES DE SERRAGE**

Tous les équipements de l'appareil doivent être cohérents avec ses spécifications, et compatibles avec l'utilisation prévue de l'appareil. Assembler et serrer les équipements conformément aux directives du fabricant.

**VÉRIFICATION DE L'ÉTANCHÉITÉ DES CONNEXIONS**

Vérifier attentivement toutes les connexions des composants pour le vide afin de garantir l'étanchéité de l'installation.

**EXPLOITATION AVEC DES PRESSIONS D'ENTRÉE NON DANGEREUSES**

Ne jamais utiliser des pressions supérieures à la pression nominale maximum (se reporter aux spécifications de l'unité pour la pression maximum admissible).

**INSTALLATION D'UN DISQUE D'ÉCHAPPEMENT ADAPTÉ**

En cas d'exploitation avec une source de gaz pressurisé, installer un disque d'échappement adapté dans le système à vide, afin d'éviter une explosion du système en cas d'augmentation de la pression.

**MAINTIEN DE L'UNITÉ À L'ABRI DES CONTAMINATIONS**

Ne pas laisser des produits contaminants pénétrer dans l'unité avant ou pendant l'utilisation. Des produits contaminants tels que des poussières et des fragments de tissu, de glace et de métal peuvent endommager l'unité d'une manière permanente ou contaminer le processus.

**RESPECT DU TEMPS D'ÉCHAUFFEMENT APPROPRIÉ POUR LES UNITÉS À TEMPÉRATURE CONTRÔLÉE**

Les unités à température contrôlée atteignent leurs spécifications uniquement quand on leur laisse un temps suffisant pour atteindre d'une manière stable la température d'exploitation. Ne pas remettre à zéro ou calibrer l'unité tant que l'échauffement n'est pas terminé.



## Medidas de seguridad del transductor de presión

### Símbolos usados en este manual de instrucciones

Definiciones de los mensajes de advertencia, precaución y de las notas usados en el manual.

#### Advertencia



---

El símbolo de advertencia indica la posibilidad de que se produzcan daños personales. Pone de relieve un procedimiento, práctica, estado, etc. que en caso de no realizarse u observarse correctamente puede causar daños personales.

---

#### Precaución



---

El símbolo de precaución indica la posibilidad de producir daños al equipo. Pone de relieve un procedimiento operativo, práctica, estado, etc. que en caso de no realizarse u observarse correctamente puede causar daños o la destrucción total o parcial del equipo.

---

#### Nota



---

El símbolo de notas indica información de importancia. Este símbolo pone de relieve un procedimiento, práctica o condición cuyo conocimiento es esencial destacar.

---

## Símbolos hallados en la unidad

La tabla siguiente contiene los símbolos que puede hallar en la unidad.















Definición de los símbolos hallados en la unidad			
			
Encendido (alimentación eléctrica) IEC 417, N° 5007	Apagado (alimentación eléctrica) IEC 417, N° 5008	Puesta a tierra IEC 417, N° 5017	Protección a tierra IEC 417, N° 5019
			
Caja o chasis IEC 417, N° 5020	Equipotencialidad IEC 417, N° 5021	Corriente continua IEC 417, N° 5031	Corriente alterna IEC 417, N° 5032
			
Corriente continua y alterna IEC 417, N° 5033-a	Equipo de clase II IEC 417, N° 5172-a	Corriente alterna trifásica IEC 617-2, N° 020206	
			
Precaución. Consulte los documentos adjuntos ISO 3864, N° B.3.1	Precaución. Riesgo de descarga eléctrica ISO 3864, N° B.3.6	Precaución. Superficie caliente IEC 417, N° 5041	

Tabla 4: Definición de los símbolos hallados en la unidad

## **Procedimientos y precauciones de seguridad**

**Las precauciones generales de seguridad descritas a continuación deben observarse durante todas las etapas de funcionamiento del instrumento. La falta de cumplimiento de dichas precauciones o de las advertencias específicas a las que se hace referencia en el manual, constituye una violación de las normas de seguridad establecidas para el uso previsto del instrumento y podría anular la protección proporcionada por el equipo. Si el cliente no cumple dichas precauciones y advertencias, MKS Instruments, Inc. no asume responsabilidad legal alguna.**

### **NO UTILICE PIEZAS NO ORIGINALES O MODIFIQUE EL INSTRUMENTO**

No instale piezas que no sean originales ni modifique el instrumento sin autorización. Para asegurar el correcto funcionamiento de todos los dispositivos de seguridad, envíe el instrumento al Centro de servicio y calibración de MKS toda vez que sea necesario repararlo o efectuar tareas de mantenimiento.

### **LAS REPARACIONES DEBEN SER EFECTUADAS ÚNICAMENTE POR TÉCNICOS AUTORIZADOS**

Los operarios no deben intentar reemplazar los componentes o realizar tareas de ajuste en el interior del instrumento. Las tareas de mantenimiento o reparación deben ser realizadas únicamente por personal autorizado.

### **TENGA CUIDADO CUANDO TRABAJE CON MATERIALES TÓXICOS**

Cuando se utilicen materiales tóxicos, es responsabilidad de los operarios tomar las medidas de seguridad correspondientes, purgar totalmente el instrumento cuando sea necesario y comprobar que el material utilizado sea compatible con los materiales del instrumento e inclusive, con todos los materiales de sellado.

### **PURGUE EL INSTRUMENTO**

Una vez instalada la unidad o antes de retirarla del sistema, purgue completamente la unidad con gas limpio y seco para eliminar todo resto de la sustancia líquida empleada anteriormente.

### **USE PROCEDIMIENTOS ADECUADOS PARA REALIZAR LA PURGA**

El instrumento debe purgarse debajo de una campana de ventilación y deben utilizarse guantes protectores.

### **NO HAGA FUNCIONAR EL INSTRUMENTO EN AMBIENTES CON RIESGO DE EXPLOSIÓN**

Para evitar que se produzcan explosiones, no haga funcionar este instrumento en un ambiente con riesgo de explosiones, excepto cuando el mismo haya sido certificado específicamente para tal uso.

**USE ACCESORIOS ADECUADOS Y REALICE CORRECTAMENTE LOS PROCEDIMIENTOS DE AJUSTE**

Todos los accesorios del instrumento deben cumplir las especificaciones del mismo y ser compatibles con el uso que se debe dar al instrumento. Arme y ajuste los accesorios de acuerdo con las instrucciones del fabricante.

**COMPRUEBE QUE LAS CONEXIONES SEAN A PRUEBA DE FUGAS**

Inspeccione cuidadosamente las conexiones de los componentes de vacío para comprobar que hayan sido instalados a prueba de fugas.

**HAGA FUNCIONAR EL INSTRUMENTO CON PRESIONES DE ENTRADA SEGURAS**

No haga funcionar nunca el instrumento con presiones superiores a la máxima presión nominal (en las especificaciones del instrumento hallará la presión máxima permitida).

**INSTALE UNA CÁPSULA DE SEGURIDAD ADECUADA**

Cuando el instrumento funcione con una fuente de gas presurizado, instale una cápsula de seguridad adecuada en el sistema de vacío para evitar que se produzcan explosiones cuando suba la presión del sistema.

**MANTENGA LA UNIDAD LIBRE DE CONTAMINANTES**

No permita el ingreso de contaminantes en la unidad antes o durante su uso. Los productos contaminantes tales como polvo, suciedad, pelusa, lascas de vidrio o virutas de metal pueden dañar irreparablemente la unidad o contaminar el proceso.

**CALIENTE ADECUADAMENTE LAS UNIDADES CONTROLADAS POR MEDIO DE TEMPERATURA**

Las unidades controladas por medio de temperatura funcionarán de acuerdo con las especificaciones sólo cuando se las caliente durante el tiempo suficiente para permitir que lleguen y se estabilicen a la temperatura de operación indicada. No calibre la unidad y no la ponga en cero hasta que finalice el procedimiento de calentamiento.

## Chapter One: General Information

### Introduction

#### Note



Some Baratron<sup>®</sup> products may not be exported to many end user countries without both US and local government export licenses under ECCN 2B230.

This manual covers the 7xxC Series Mini Baratron<sup>®</sup> pressure transducers designed for standard applications. The transducers included in this series are listed in Table 5, and are RoHS (Restriction of Hazardous Substances)-compliant. These transducers offer the proven technology of the Baratron transducers in a considerably smaller package. The relay system option attaches to the single-ended transducer and provides two alarm relays.

7xxC Series Model Selection Guide			
	STANDARD		
Process Measurement	Gage	Absolute	
Single-ended	740C	750C	
Single-ended with Relay System	R740C	R750C	
Flow-Through	742C	752C	

Table 5: The 7xxC Series Model Selection Guide

Each transducer in the 7xxC Series is “customized” to your needs because you select the:

- *transducer type*: absolute, standard (non-compound) gage, or compound calibration gage
- *style*: single-ended or flow- through; with or without a relay system
- *range*: from 10 Torr to 3000 psia, depending on the model (Refer to page 65, *Appendix A: Product Specifications*, for a list of ranges.)
- *fittings*: Tube, Swagelok VCR<sup>®</sup>, NPT, NW-16-KF (up to 1200 Torr only), or customer specified
- *output configuration*: 0 to 5 VDC, 0 to 10 VDC, or 4 to 20 mA
- *electrical connector*: the standard 9-pin Type “D” or optional Bendix<sup>®</sup> 4 position PTO (available in two pinout configurations), 15-pin High Density Type “D,” or Flying Leads

## **How This Manual is Organized**

This manual is designed to provide instructions on how to set up and install a 7xxC Series unit.

**Before installing your 7xxC-Series unit in a system and/or operating it, carefully read and familiarize yourself with all precautionary notes in the *Safety Messages and Procedures* section at the front of this manual. In addition, observe and obey all WARNING and CAUTION notes provided throughout the manual.**

*Chapter One: General Information*, (this chapter) introduces the product and describes the organization of the manual.

*Chapter Two: Installation*, explains the environmental requirements and describes how to mount the instrument in your system.

*Chapter Three: Overview*, gives a brief description of the instrument and its functionality.

*Chapter Four: Operation*, describes how to use the instrument and explains all the functions and features.

*Chapter Five: Type R7xxC Relay System*, discusses the Type R7xxC relay system, which consist of a Type 740C or 750C pressure transducer connected to a relay module.

*Chapter Six: Maintenance and Troubleshooting*, provides a checklist for reference in the event your unit malfunctions.

*Appendix A: Product Specifications*, lists the specifications of the instrument.

*Appendix B: Model Code*, describes the product model code for reference purposes.

## **Customer Support**

Standard maintenance and repair services are available at all of our regional MKS Calibration and Service Centers listed on the back cover. In addition, MKS accepts the instruments of other manufacturers for recalibration using the Primary and Transfer Standard calibration equipment located at all of our regional service centers. Should any difficulties arise in the use of your 7xxC Series instrument, or to obtain information about the companion products and services that MKS offers, contact any authorized MKS Calibration and Service Center. If it is necessary to return the instrument to MKS, please obtain an RMA (Return Material Authorization) Number from the MKS Calibration and Service Center before shipping. The RMA Number expedites handling and ensures proper servicing of your instrument.

Please refer to the inside of the back cover of this manual for a list of MKS Calibration and Service Centers.

---

**Warning**

**All returns to MKS Instruments must be free of harmful, corrosive, radioactive, or toxic materials.**

---

This page intentionally left blank.



## Chapter Two: Installation

### How To Unpack the 7xxC Series Unit

MKS has carefully packed the 7xxC Series unit so that it will reach you in perfect operating order. Upon receiving the unit, however, you should check for defects, cracks, broken connectors, etc., to be certain that damage has not occurred during shipment.

**Note**

---

Do *not* discard any packing materials until you have completed your inspection and are sure the unit arrived safely.

---

If you find any damage, notify your carrier and MKS immediately. If it is necessary to return the unit to MKS, obtain an RMA (Return Material Authorization) Number from the MKS Service Center before shipping. Please refer to the inside of the back cover of this manual for a list of MKS Calibration and Service Centers.

### Unpacking Checklist

***Standard Parts:***

- Type 740C/742C/750C/752C pressure transducer, R7xxC relay system
- 7xxC Series Instruction Manual (this book)

***Optional Accessories:***

- Electrical Connector Accessories Kit, XXXX-K1 (includes a mate to the electrical connectors)
- Most pressure, flow, flow ratio, and throttling valve controllers
- MKS LDM Local Display Module
- MKS Type 146, Type 660, Type PDR-C-1C or PDR-C-2C power supply/readout unit (For compound gauges or mA gauges with the sampling resistor, use the Type 660 readout.)
- Interface Cables

For transducer cables, refer to Table 6, page 23. For cables to connect to the R750 relay system, consult the factory.

You may need to purchase the appropriate cables to connect the 7xxC/800B Series unit to the above accessories.

## **Product Location and Requirements**

- Ambient operating temperature: 0° to 50° C (32° to 122° F)

For additional product requirements, refer to *Appendix A: Product Specifications*, page 65.

## **Interface Cables**

*As of July 20, 2009, most products shipped to the European Community must comply with the EMC Directive 2004/108/EC, which covers radio frequency emissions and immunity tests. In addition, as of January 1, 1997, some products shipped to the European Community must also comply with the Product Safety Directive 92/59/EC and Low Voltage Directive 73/23/EC, which cover general safety practices for design and workmanship. MKS products that meet these requirements are identified by application of the CE Mark.*

To ensure compliance with EMC Directive 2004/108/EC, an overall metal braided shielded cable, properly grounded at both ends, is required during use. No additional installation requirements are necessary to ensure compliance with Directives 92/59/EC and 73/23/EC.

### **Note**



1. An overall metal braided, shielded cable, properly grounded at both ends, is required during use to meet CE specifications.
2. To order an overall metal braided shielded cable, add an “S” after the cable type designation. For example, to order a 9-pin Type “D” cable to connect a 740 transducer to a Type PDR-C-1 readout, use part number CB700-2-XX, where XX designates the cable length; for a braided, shielded cable use part number CB700S-2-XX.

<b>Interface Cables</b>			
<b>Transducer Connector</b>	<b>MKS Power Supply/Readout</b>	<b>Cable Description</b>	<b>Cable Number</b>
9-pin Type “D”	Type 146, 660	9-pin Type “D” to 15-pin Type “D”	CB700-1-XX, CB700S-1-XX
	PDR-C-1, PDR-C-2	9-pin Type “D” to flying leads	CB700-2-XX, CB700S-2-XX
Bendix	Type 146, 660	Bendix to 15-pin Type “D”	CB700-3-XX, CB700S-3-XX
	PDR-C-1, PDR-C-2	Bendix to flying leads	CB700-4-XX, CB700S-4-XX
15-pin High Density Type “D”	Type 146, 660	15-pin Type “D” to 15-pin Type “D”	CB700-5-XX, CB700S-5-XX
	PDR-C-1, PDR-C-2	15-pin Type “D” to flying leads	CB700-6-XX, CB700S-6-XX
<i>where XX indicates the length of the cable, in feet</i>			

Table 6: Interface Cables

This MKS product meets CE requirements per EMC Directive 2004/108/EC. To ensure compliance when installed, an overall metal braided shielded cable, properly grounded at both ends, is required during use. Adhere to the following specifications if you choose to make your own cable. Braided shielded cable assemblies are recommended if the environment contains high EMI/RFI noise.

### Generic Shielded Cable Description

MKS offers a full line of cables for all MKS equipment. Should you choose to manufacture your own cables, follow the guidelines listed below:

1. The cable must have an overall metal *braided* shield, covering all wires. Neither aluminum foil nor spiral shielding will be as effective; using either may nullify regulatory compliance.
2. The connectors must have a metal case which has direct contact to the cable's shield on the whole circumference of the cable. The inductance of a flying lead or wire from the shield to the connector will seriously degrade the shield's effectiveness. The shield should be grounded to the connector before its internal wires exit.
3. With very few exceptions, the connector(s) must make good contact to the device's case (ground). "Good contact" is about 0.01 ohms; and the ground should surround all wires. Contact to ground at just one point may not suffice.
4. For shielded cables with flying leads at one or both ends; it is important at each such end, to ground the shield *before* the wires exit. Make this ground with absolute minimum length. Refer to Figures 1 and 2, page 25. (A ¼ inch piece of #22 wire may be undesirably long since it has approximately 5 nH of inductance, equivalent to 31 ohms at 1000 MHz). After picking up the braid's ground, keep wires and braid flat against the case. With very few exceptions, grounded metal covers are not required over terminal strips. If one is required, it will be stated in the Declaration of Conformity or in the instruction manual.
5. In selecting the appropriate type and wire size for cables, consider:
  - A. The voltage ratings;
  - B. The cumulative  $I^2R$  heating of all the conductors (keep them safely cool);
  - C. The IR drop of the conductors, so that adequate power or signal voltage gets to the device;
  - D. The capacitance and inductance of cables which are handling fast signals, (such as data lines or stepper motor drive cables); and
  - E. That some cables may need internal shielding from specific wires to others; please see the instruction manual for details regarding this matter.

**Example 1: Preferred Method To Connect Cable**  
 (shown on a transducer)

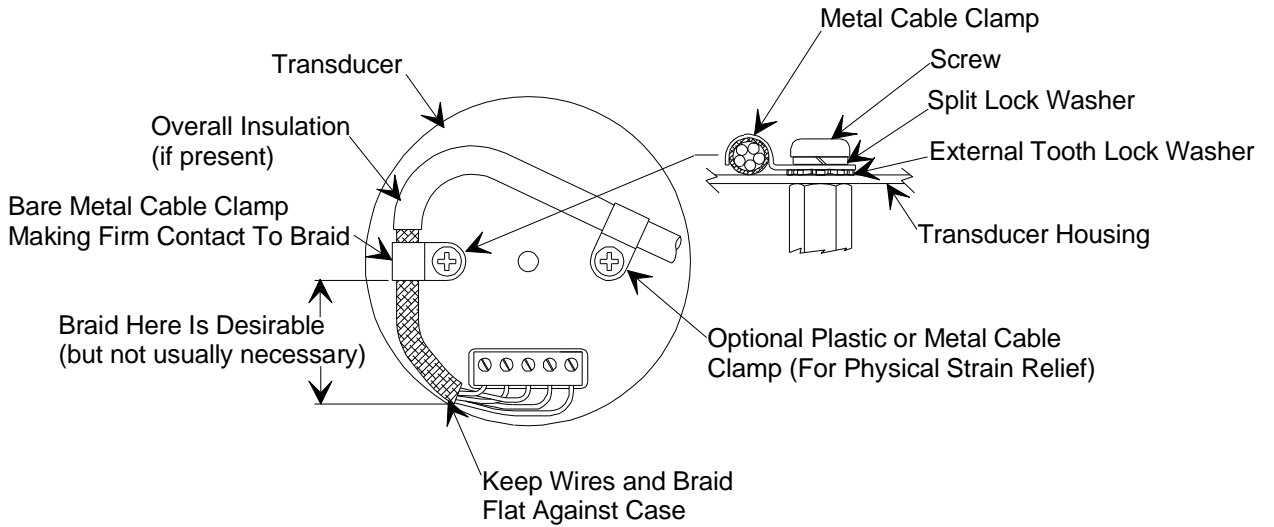

Figure 1: Preferred Method

**Example 2: Alternate Method To Connect Cable**  
 (shown on a transducer)

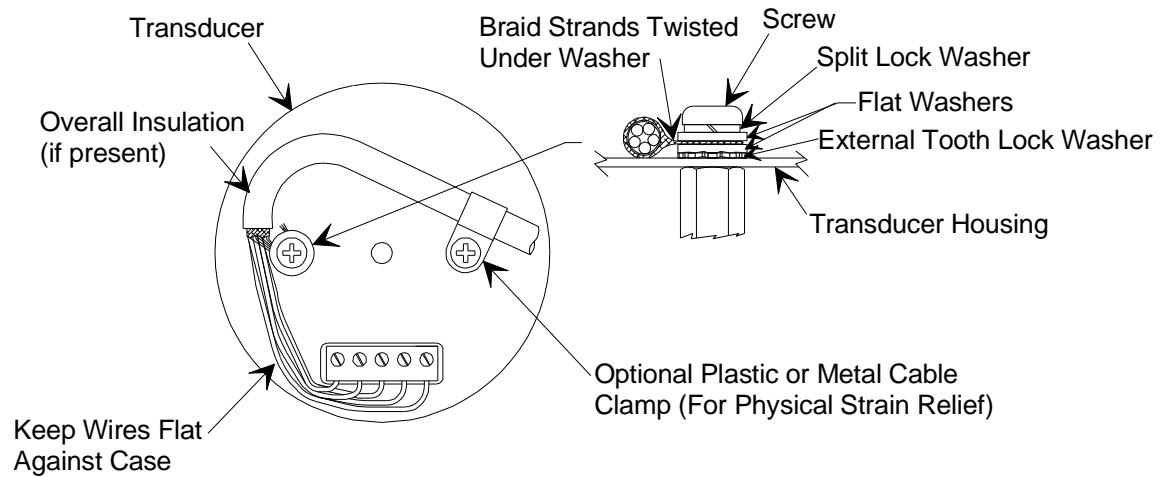

Figure 2: Alternate Method To Use When Cable Clamp is Not Available

## Setup

### Mounting the Unit

The 7xxC Series unit can be mounted with the cylindrical end in either a vertical or horizontal position. The mounting requirements allow any foreign matter entering the pressure port to fall *away from* the sensing diaphragm.

#### *Mounting the Unit in a Vertical Position*

Mount a unit with high full scale pressure (greater than or equal to 20 psi) in any position vertically. If the unit has a low full scale pressure (less than 20 psi) and is used with gases that contain particulates, mount it in a vertical position with the cylindrical end of the unit pointing upward, as shown in Figure 3, page 26. Do not install such a unit with the cylindrical end of the unit pointing downward because particulate impurities may accumulate on the sensing diaphragm and alter the pressure reading.

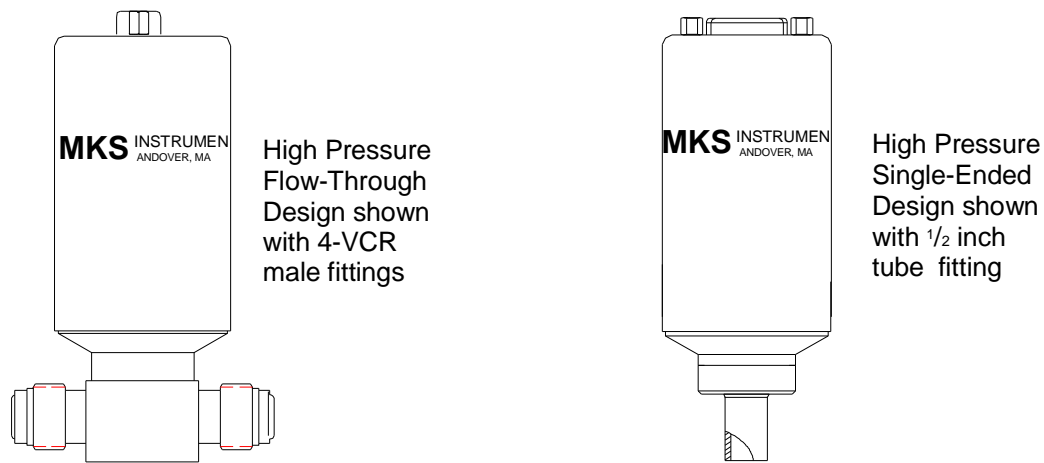
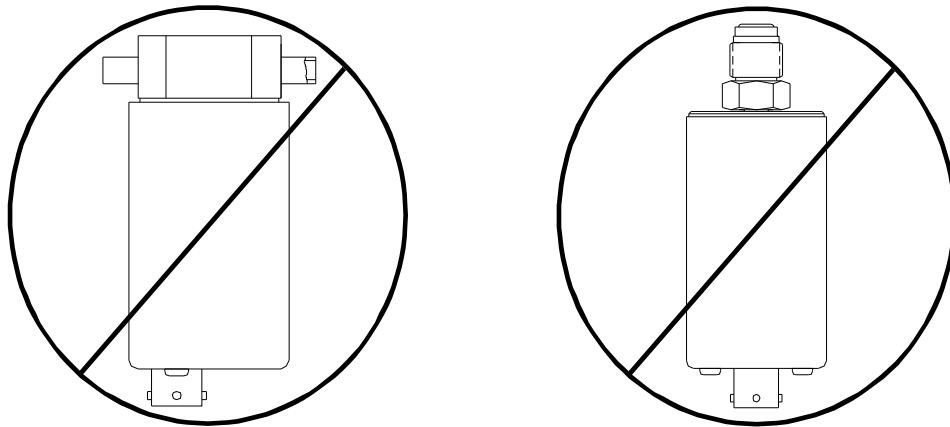

Figure 3: Acceptable Vertical Mounting Positions

Flow-Through Low Pressure Units ( $\leq 1200$  Torr)Single-Ended Low Pressure Units ( $\leq 1200$  Torr)Figure 4: **Unacceptable** Vertical Mounting Positions (units < 20 psi full scale)

### ***Mounting the Unit in a Horizontal Position***

In a horizontal position, the cylindrical end of the unit can point in any direction. In addition, with the flow-through design, the fittings can be positioned to accommodate either a vertical or horizontal flow.

Flow-Through Design shown with 4-VCR male fittings



Single-Ended Design shown with 4-VCR male fittings



Figure 5: Acceptable Horizontal Mounting Positions

## Fittings

The 7xxC Series transducers are available with a variety of different fittings, shown in Table 7:

Fittings Available*	
7xxC Single-Ended Configuration	7xxC Flow-Through Configuration
½" Tube	¼" Tube
Swagelok® 4-VCR® Male and Female	Swagelok 4-VCR Fixed Male
Swagelok 8-VCR Female	Swagelok 4-VCR Female
NW16-KF **	
* Other configurations are available on request. Minimum quantities may be required. ** Up to 1200 Torr only	

Table 7: Fittings Available

### Caution



1. MKS *does not warranty* the 7xxC Series transducers when single or double metal ferrule compression-type vacuum fittings are used because damage will occur to the transducer when improper tightening procedures are followed.
2. Before proceeding to the *Setup* section, page 23, carefully check all plumbing connections to the instrument to ensure a leak-tight installation.

### NW16 -KF Fitting Information

The NW16-KF fittings are only available for units with full scale pressure of a maximum of 1200 Torr (23 psia).

### Warning



Units with NW-16-KF fittings and a full scale range greater than 1200 Torr (23 psia or 5 psig) require an HPS overpressure ring. Operating the unit without a protective overpressure ring may result in injury.

The HPS part number for the overpressure ring is HPS 100316301.



### Making Welded Connections

To weld a transducer in line to a system, you should follow certified welding practices, such as those published by the American Welding Society (AWS) or the American Society of Mechanical Engineers (ASME).

---

**Warning**

**Improper welding can cause personal injury or damage equipment. Follow proper welding procedures at all times.**

---

### Making Mechanical Connections

To make mechanical connections in line to a system, use the recommended installation practices, as specified by the fitting manufacturer or by an appropriate standard.

---

**Warning**

**Improper installation can cause personal injury or damage equipment. Follow proper installation procedures at all times.**

---

### *How To Tighten Fitting Attachments*

*For VCR Fittings:* Tighten  $\frac{1}{8}$  turn past the finger tight position for 316 SS or nickel gaskets.

*For NPT Threads:* Follow the procedure described in ANSI B1.20.1.

### Electrical Information for a Current Unit

The 7xxC Series transducers with 4 to 20 mA output require an external power source capable of supplying the voltages listed in *Appendix A: Product Specifications*, page 65. Figure 8 shows the electrical information for a 4 to 20 mA unit. The total external line resistance, including the sampling resistor, must not exceed the value  $R_{LN}$  determined by:

$$R_{LN} \text{ (ohms)} = \frac{(\text{Excitation Supply Volts} - 13) \times 10^3}{24}$$

Figure 6: Line Resistance Equation

For example,  $R_{LN}$  should not exceed 450 ohms for a 24 Volt supply.

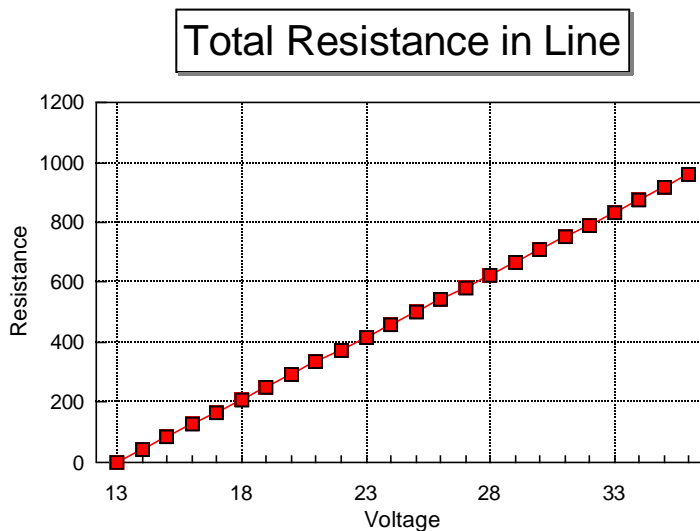

Figure 7: Total Resistance in Line

The maximum voltage between ground (sensor case) and the (-) terminal must not exceed 36 Volts for mA units. The maximum voltage between the positive (+) terminal and the (-) terminal must not exceed 32 Volts under any conditions. Use the ZERO pot to adjust the 4 mA setting. Refer to *How To Check the Transducer Zero*, page 41, to adjust the zero. The SPAN pot adjusts the 20 mA setting. Refer to *Span Adjustment*, page 44, for more information.

Ordinary, unshielded twisted pair transmission wire can be used for all connections.

**Note**

If the unit is considerably out of calibration, the zero and span adjustments could interact slightly. It may take more than one calibration cycle to accurately complete the adjustments. Always recheck the zero calibration after adjusting the span. Refer to *Span Adjustment*, page 44, for more information.

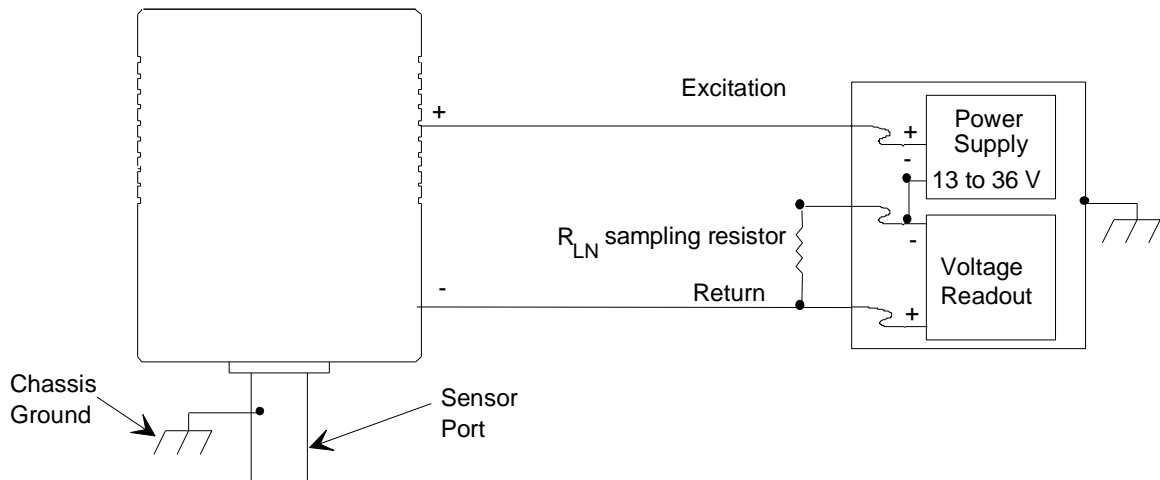

Figure 8: Electrical Scheme for the 4 to 20 mA Unit

### Electrical Information for a Voltage Unit

The 7xxC-series transducers require an external power source capable of supplying the voltages listed in *Appendix A: Product Specifications*, page 65. Noise and ripple should be less than 2 mV (peak-to-peak) over a 10 kHz bandwidth. You may use any readout device capable of reading from -0.6 V to 11 V. Refer to Figure 9, page 32, for the power, signal and chassis grounding scheme for a voltage unit.

#### Note



The ground of any external power supply and readout should be the same as the transducer ground (chassis ground) to minimize any possible ground loops and power supply noise which can affect the performance and stability of the system.

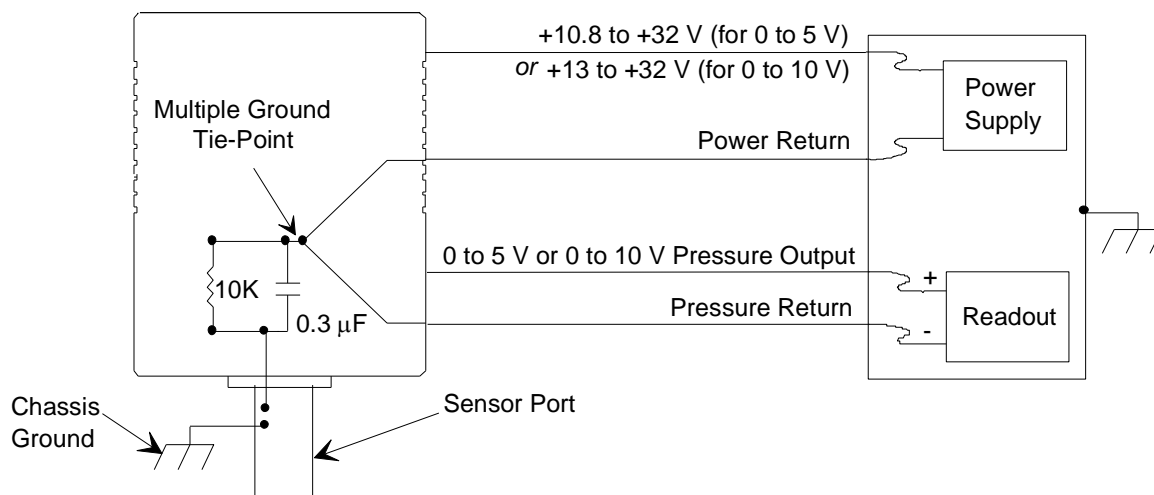

**Note 1:** For best results, use a readout with fully differential inputs.

**Note 2:** The absolute value of the potential difference between the chassis ground and signal common/power ground should not exceed 14 Volts.

Figure 9: Electrical Scheme for a Voltage Unit

## Connectors

The 7xxC Series transducers are available with a variety of connector options. The connector options, and the tables that list each pinout, are listed below:

- 9-pin Standard Type “D” (refer to Table 8, page 34)
- 15-pin High Density Type “D” (refer to Table 9, page 34)
- Two configurations of a Bendix connector (refer to Table 10 and Table 11, page 35)
- Two configurations of Flying Leads (refer to Table 12 and Table 13, page 36)

---

### Note



A “Reserved” pin assignment refers to a pin with an internal connection, that may be assigned a function in the future.

---

<b>9-Pin Type “D” Connector Pinout</b>	
<b>Pin</b>	<b>Signal</b>
1	Pressure Output
2	Reserved
3	Reserved
4	+ Power Input <i>or</i> 4 to 20 mA positive excitation
5	Reserved
6	Reserved
7	Reserved
8	Pressure Return
9	Power Return <i>or</i> 4 to 20 mA negative excitation

Table 8: 9-Pin Type “D” Connector Pinout

<b>15-Pin High Density Type “D” Connector Pinout</b>	
<b>Pin</b>	<b>Signal</b>
1	Reserved
2	Pressure Output
3	Reserved
4	Reserved
5	Power Return <i>or</i> 4 to 20 mA negative excitation
6	Reserved
7	+ Power Input <i>or</i> 4 to 20 mA positive excitation
8	Reserved
9	Reserved
10	Reserved
11	Reserved
12	Pressure Return
13	Reserved
14	Reserved
15	Reserved

Table 9: 15-Pin High Density Type “D” Connector Pinout

<b>Bendix 4 Position PTO Connector Option 1 Pinout</b>	
<b>Pin</b>	<b>Signal</b>
A	+ Power Input <i>or</i> 4 to 20 mA positive excitation
B	Pressure Output
C	Pressure Return
D	Power Return <i>or</i> 4 to 20 mA negative excitation

Table 10: Bendix 4 Position PTO Connector Option 1 Pinout

<b>Bendix 4 Position PTO Connector Option 2 Pinout</b>	
<b>Pin</b>	<b>Signal</b>
A	4 to 20 mA positive excitation
B	Jumpered to pin D
C	Reserved
D	4 to 20 mA negative excitation
<i>This pinout is only available with a 4 to 20 mA output unit</i>	

Table 11: Bendix 4 Position PTO Connector Option 2 Pinout

<b>Flying Leads (Model Code F) Pinout</b>	
<b>Color</b>	<b>Signal</b>
Red	Pressure Output
Black	Pressure Return
White	Power Return <i>or</i> 4 to 20 mA negative excitation
Green	+ Power Input <i>or</i> 4 to 20 mA positive excitation

Table 12: Flying Leads (Model Code F) Pinout

<b>Flying Leads (Model Code L) Pinout</b>	
<b>Color</b>	<b>Signal</b>
Red	+ Power Input <i>or</i> 4 to 20 mA positive excitation
Black	Power Return <i>or</i> 4 to 20 mA negative excitation
White	Pressure Return
Green	Pressure Output

Table 13: Flying Leads (Model Code L) Pinout



## Dimensions

### Note



All dimensions are listed in inches with millimeters referenced in parentheses.

### Single Ended Version

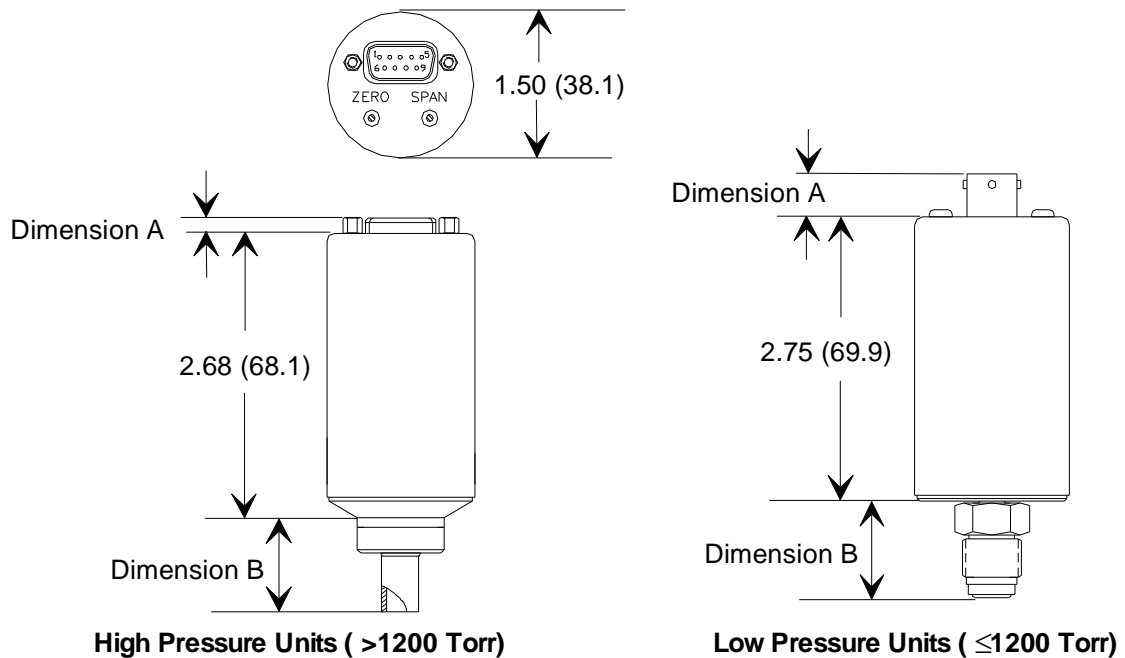

Figure 10: Dimensional Drawing of the Single-Ended Design

Dimensions for Connectors and Fittings for Single-Ended Units				
Dimension A	9-pin Type "D"	15-pin Type "D"	Bendix	Flying Leads
	0.19 (4.8)	0.19 (4.8)	0.41 (10.5)	0.73 (18.5)
Dimension B	4-VCR (M or F)	8-VCR (F)	½" Tube	NW-16-KF
Low Range	0.94 (23.9)	1.40 (35.5)	0.76 (19.2)	0.86 (21.7)
High Range	1.36 (34.4)	1.71 (43.4)	1.07 (27.1)	*
* The NW16-KF fitting is only available in units up to 1200 Torr (full scale pressure)				

Table 14: Dimensions for Connectors and Fittings for Single-Ended Units

### Flow-Through Version

The overall length of a flow-through unit, from fitting end to fitting end, varies with the type of fitting chosen.

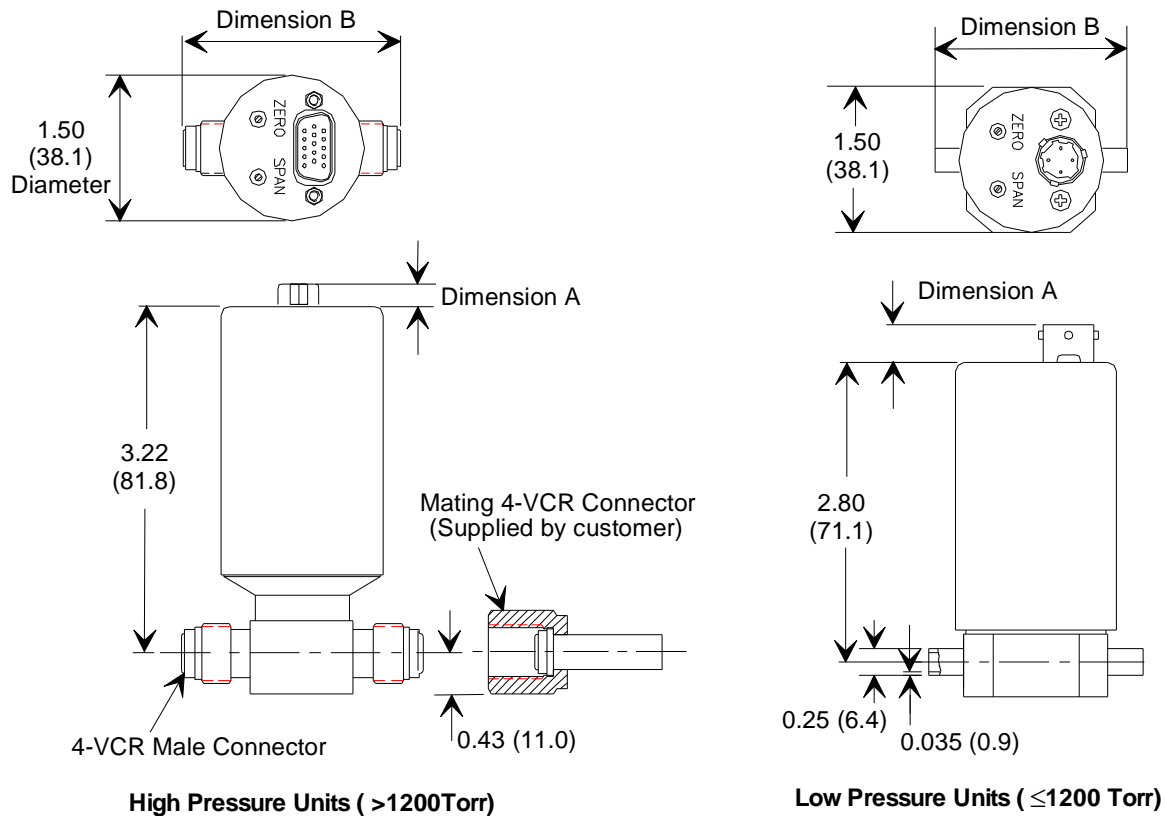

Figure 11: Dimensional Drawing of the Flow-Through Design

Dimensions for Connectors and Fittings for Flow-Through Units				
Dimension A	9-pin Type “D”	15-pin Type “D”	Bendix	Flying Leads
	0.19 (4.8)	0.19 (4.8)	0.35 (8.9)	0.73 (18.5)
Dimension B (Overall Body Length, inches (mm))			4-VCR male, fixed	¼” Tube
Low Range			2.78 (70.6)	2.00 (50.8)
High Range			2.24 (56.9)	2.045 (51.9)

Table 15: Dimensions for Connectors and Fittings for Flow-Through Units

## How To Connect to a Type PDR Series Readout

This section provides information on how to wire a Type PDR Series readout to a Type 7xxC transducer with either a Type “D” or Bendix connector.

---

**Caution**  **DO NOT use the -15 VDC output of the Type PDR readout to power the 7xxC/800B Series transducer. When the -15 VDC signal of the PDR is connected to the power return of the transducer, a short between the -15 VDC of the transducer and the A GND of the PDR occurs. The PDR readout will blank out. Either unit may be damaged.**

---



---

**Note**  This information replaces the color code information found in the PDR manuals.

---

### **Type “D” Connector (either 9-pin or 15-pin High Density)**

The correct cable to use for the 9 pin Type “D” connector is CB700-2; the cable for 15-pin High Density connector is CB700-6. The correct cable has the mating Type “D” connector on the transducer end and flying leads on the PDR end. Table 16 lists the pin assignments for the various colored wires on the flying leads end of the cable.

<b>Connections Between a PDR Readout and a Transducer (Type “D” Connector)</b>		
<b>Transducer Signal</b>	<b>Flying Lead Color Code (CB700-6 and CB700-2)</b>	<b>PDR Signal</b>
Pressure Output	Red	Pressure Input
+ Power Input	Green	+ 15 VDC
Pressure Return	Black	Signal Ground (A GND)
Power Return	White	Power Ground (D GND)

Table 16: Connections Between PDR Readout and a Transducer (Type “D” Connector)

**Bendix Connector (option 1 pinout)**

The correct cable to use for the Bendix connector is CB700-4, which has the mating Bendix connector on the transducer end and flying leads on the PDR end. Table 10 lists the pin assignments for the various colored wires on the flying leads end of the cable.

<b>Connections Between a PDR Readout and a Transducer (Bendix Connector)</b>		
<b>Transducer Signal</b>	<b>Flying Lead Color Code (CB700-4)</b>	<b>PDR Signal</b>
Pressure Output	Green	Pressure Input
+ Power Input	Red	+ 15 VDC
Pressure Return	White	Signal Ground (A GND)
Power Return	Black	Power Ground (D GND)

Table 17: Connections Between a PDR Readout and a Transducer (Bendix Connector)

## How To Check the Transducer Zero

Check the transducer zero prior to the initial operation and then periodically as required. The zero can be set (or reset) by adjusting the zero potentiometer located on the top cover of the transducer or, on the front panel of an MKS Power Supply/Readout, if you are using one.

### Note



To set the zero on a compound calibration gauge you must set the output to a fixed value, as listed in Table 19, page 44.

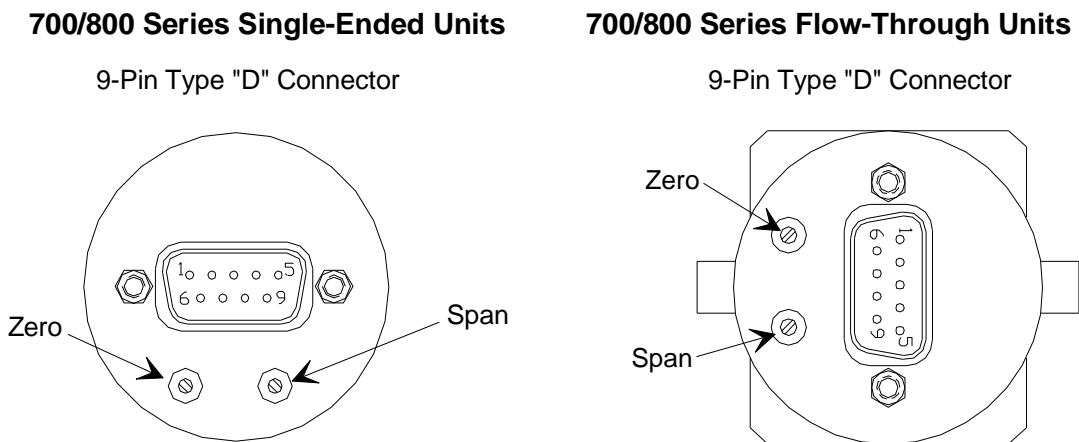

Figure 12: Top Cover

## How To Zero an Absolute Transducer

To zero an absolute transducer, you must pump the unit, with the power on, down to a pressure less than the transducer's resolution (0.01% of Full Scale).

---

**Note**

The zero adjustment *must* be made at a pressure less than the transducer's resolution (0.01% of F.S.).

In addition, you should position the transducer in the *same orientation* as it will be positioned when installed in your system.

---

Zeroing a transducer at a pressure above its stated minimum resolution creates a *zero offset* relative to true absolute pressure. All subsequent readings are then linear and accurate *relative to the offset value*.

---

**Note**

If your system cannot achieve a sufficiently low pressure to set the transducer zero, you may use a vacuum leak detector with sufficient vacuum pumping (to achieve proper zeroing pressures). In this case, mount the transducer on the leak detector *in the same plane of orientation as it will be during actual use*.

---

To properly zero an absolute transducer, follow this procedure:

1. Install the transducer in a system and connect a power supply/readout.
2. Pump the system down to a pressure below the resolution of the transducer.  
Refer to Table 18, page 43, for recommended pressure levels.
3. Using a small screwdriver, adjust the ZERO pot until the readout displays zero (0000).  
Refer to Figure 12, page 41, for the location of the ZERO pot.

<b>Highest Pressure for Proper Zero Adjustment</b>	
<b>Full Scale Range</b>	<b>Pressure</b>
10 Torr	$< 5 \times 10^{-4}$ Torr
100 Torr	$< 5 \times 10^{-3}$ Torr
1000 Torr	$< 5 \times 10^{-2}$ Torr
30 psia	$< 1 \times 10^{-3}$ psia
100 psia	$< 5 \times 10^{-3}$ psia
500 psia	$< 2 \times 10^{-2}$ psia
1000 psia	$< 5 \times 10^{-2}$ psia
2000 psia	$< 0.1$ psia
3000 psia	$< 0.1$ psia

Table 18: Highest Pressure for Proper Zero Adjustment

## How To Zero a Gage Unit

### *Standard (non-compound) Gage Units*

To properly zero a standard (non-compound) gage unit:

1. Install the transducer in a system with a power supply/readout.
2. Open the process port to local atmospheric pressure.

#### **Note**



---

The “reference” of the transducer is always open to the local atmospheric conditions. The zero is set only when the P<sub>x</sub> (process port) is also open to local atmospheric pressure.

---

3. Adjust the ZERO pot until the readout displays zero (0000).

### Compound Gage Units

To properly zero a compound gage unit:

1. Install the transducer in a system with a power supply/readout.
2. Open the process port to local atmospheric pressure.

#### Note



The “reference” of the transducer is always open to the local atmospheric conditions. The zero is set only when the P<sub>x</sub> (process port) is also open to local atmospheric pressure.

3. Adjust the ZERO pot until the readout displays the voltage, or current, listed in Table 19.

#### Note



Compound Calibrations are gage instruments that provide an output above and below ambient pressure. The zeroing process sets the output to the value listed in Table 19 when the input pressure equals the local atmospheric pressure. This is the output value of the unit *whenever* the input pressure equals the local atmospheric pressure, even if the local atmospheric pressure has changed since the zero was set.

Output of a Compound Gage Unit at 0 psig			
Range inHg - 0 - psig	Output: 0 to 5 VDC	Output: 0 to 10 VDC	Output: 4 to 20 mA
30 - 0 - 30	1.6469 V	3.2938 V	9.270 mA
30 - 0 - 100	0.6421 V	1.2842 V	6.055 mA
30 - 0 - 250	0.2783 V	0.5566 V	4.891 mA
30 - 0 - 500	0.1431 V	0.2863 V	4.458 mA
30 - 0 - 1000	0.0726 V	0.1452 V	4.232 mA
30 - 0 - 2000	0.0366 V	0.0731 V	4.117 mA
30 - 0 - 3000	0.0244 V	0.0489 V	4.078 mA

Table 19: Output of a Compound Gage Unit at 0 psig

### Span Adjustment

The span setting may require adjustment periodically. Only adjust the SPAN pot in conjunction with a calibration transfer standard. **Do not** adjust the span setting if a calibration transfer standard is not available. Instead, send the unit back to an MKS Service Center for calibration.





## Chapter Three: Overview

### General

A complete pressure transducer system requires three components to convert pressure to a linear DC voltage output: a sensor, signal conditioner, and power supply. An analog or digital meter is required to display the DC output in pressure units.

The MKS 7xxC Series transducers contain two of the above components: the sensor and signal conditioner. An MKS or MKS-compatible power supply is required to complete the pressure to DC voltage output conversion, and an MKS or MKS-compatible display unit is required for direct pressure readout. The display unit could be a personal computer, an MKS pressure controller, or an MKS PDR Series power supply/readout unit.

### Sensor

The variable capacitance sensor consists of a pressure inlet tube (port) connected to a small chamber in the transducer body. One wall of this chamber is a metal diaphragm. The front side of the diaphragm is exposed to the gas whose pressure is to be measured. The back, or *reference*, side of the diaphragm faces a rigidly mounted ceramic disc containing two electrodes. The diaphragm in the single-ended version is positioned opposite the inlet port. The diaphragm on the flow-through version is positioned above the gas stream. Figure 3, page 26, and Figure 5, page 27, show the design of the flow-through and single-ended versions.

The reference side of the absolute version is permanently evacuated below the resolution of the instrument and its vacuum is maintained with a chemical getter system. The reference side of the gage version is open to the atmosphere. Since its pressure should not be altered, there is no connector on the reference side. The reference side of the compound version is also open to the atmosphere.

The diaphragm deflects with changing pressure (force per unit area) independently of the gas type or composition of the measured gas. This deflection causes an imbalance of the sensor electrode capacitances since the distance to the diaphragm is now different for each electrode. Using a precision constant frequency oscillator for excitation, the imbalance of capacitances is converted to a DC voltage. The resultant signal is then linearized, zeroed, and amplified via the signal conditioner electronics, to produce a precise output signal scaled to the range of the transducer.

## **Signal Conditioning Electronics**

The signal conditioner contains state-of-the-art balanced bridge circuitry, self-compensated for thermal stability with ambient temperature changes. The circuit board construction uses surface mount technology. The output is either a DC voltage or mA current, which is linear with pressure. The transducer is then calibrated against a transfer standard to provide the selected output over the range of the transducer.



## Chapter Four: Operation

### General

After installation and during periodic maintenance, check the transducer zero (for compound calibration gauges check the voltage or current reading) to verify proper output. If the output is incorrect, set the output by adjusting the zero potentiometer. Refer to *How To Check the Transducer Zero*, page 41, for zeroing instructions.

### **Lowest Suggested Pressure Available for Reading**

The pressures listed in the middle column of Table 20 reflect reliable and practical pressures for different range transducers. Lower readings may be obtained in environments which have stable temperature and air flow.

### **Lowest Suggested Pressure to Use for Control**

The pressures listed in the last column of Table 20 are for reference, and represent the pressure reading of the transducer at 50 mV signal output. A DC signal of at least 50 mV is the recommended minimum signal level to use when integrating any transducer into complex processing systems.

<b>Suggested Pressures for Reading and Control</b>		
<b>Full Scale Range</b>	<b>Lowest Suggested Pressure for Reading</b>	<b>Lowest Suggested Pressure for Control</b>
10 Torr	$5 \times 10^{-3}$ Torr	$5 \times 10^{-2}$ Torr
100 Torr	$5 \times 10^{-2}$ Torr	$5 \times 10^{-1}$ Torr
1000 Torr	0.5 Torr	5 Torr
30 psia	$3 \times 10^{-2}$ psia	$3 \times 10^{-1}$ psia
100 psia	0.1 psia	1 psia
500 psia	0.5 psia	5 psia
1000 psia	1 psia	10 psia
2000 psia	2 psia	20 psia
3000 psia	3 psia	30 psia

Table 20: Suggested Pressures for Reading and Control

This page intentionally left blank.

## Chapter Five: Type R7xxC Relay System

### General Information

The Type R7xxC pressure relay system consists of a 74xC or 75xC transducer attached to a relay module. The relay module provides two alarm trip points, two relays, and two status LEDs. The pressure transducer functions exactly the same as units without the relay module. Refer to *Chapter Three: Overview*, page 46, for a description of the pressure transducer.

### Initial Settings

The relay module enables you to select the pressure condition that will energize, or activate, each relay. You can configure the module to energize a relay when the pressure drops below the trip point, or when the pressure rises above the trip point. Each relay functions independently. The initial configuration is described in Table 21.

Initial Settings for the Relay System	
Parameter	Setting
Trip Point A State Setting	Energized <i>below</i> the trip point setting 55% F. S.
Trip Point B State Setting	Energized <i>above</i> the trip point setting 55% of F.S.

Table 21: Initial Settings for the Relay System

- Trip point A is energized *below* the trip point (it is de-energized when the pressure is above the trip point value and it is energized when the pressure falls below the trip point)
- Trip point B is energized *above* the trip point (it is de-energized when the pressure is below the trip point value and it is energized when the pressure exceeds the trip point)

You can change the trip point values by turning the trip point adjust pots on the side of the unit.

#### Note



The trip point adjustment voltage ranges from 0 to 10 Volts, corresponding to zero to full scale.

## Trip Point Parameters

### *Trip Point Values*

The trip point values are adjusted using the Trip Point Adjustment pots located on the side of the Relay Module (refer to Figure 13). The adjustment voltage ranges from 0 to 10 V, corresponding to zero to full scale. The pots are initially configured to 5.5 V; that is, 55% of FS.

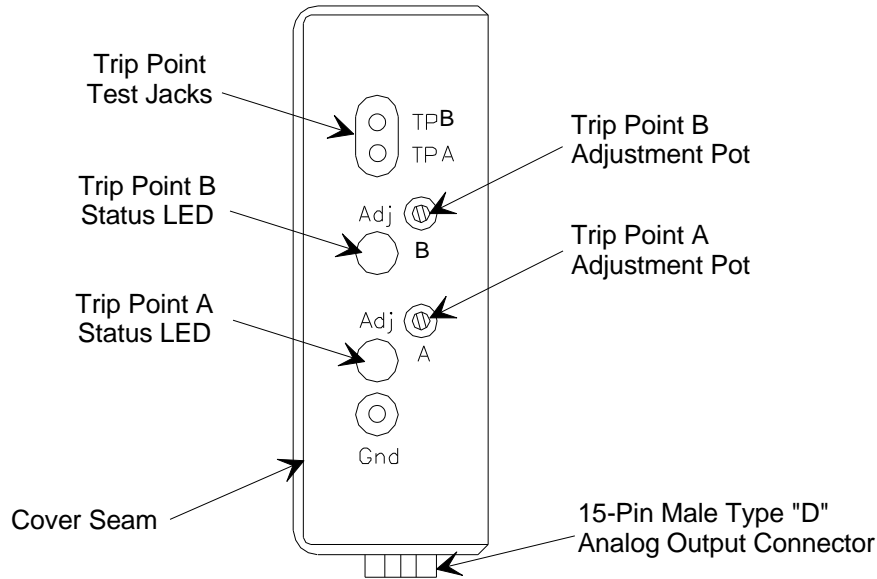

Figure 13: Location of the Trip Point Adjustment Pots



### ***Trip Point Direction***

The trip point polarity, or direction, defines the direction of pressure change that will energize the hardware trip points; each relay functions independently. The trip point direction is controlled by jumpers on the PC board inside of the Relay Module. You can change the direction for either trip point by adjusting the appropriate jumper setting on the PC board (refer to *How To Configure the Trip Points*, page 60, for more information).

The initial direction for Trip Point A is “low”; the trip point is energized as the pressure falls *below* the specified trip point level. The trip point is not deenergized until the pressure rises above the value defined by the Trip Point A hysteresis, as shown in Figure 14.

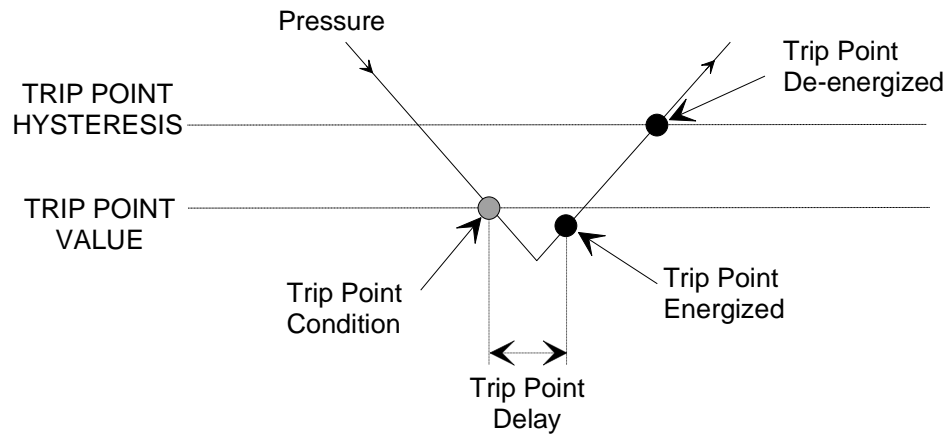

Figure 14: Trip Point Direction Set Low

The initial direction for Trip Point B is “high”; the trip point is energized as the pressure rises *above* the specified trip point level. The trip point is not deenergized until the pressure falls below the value defined by the Trip Point B hysteresis, as shown in Figure 15.

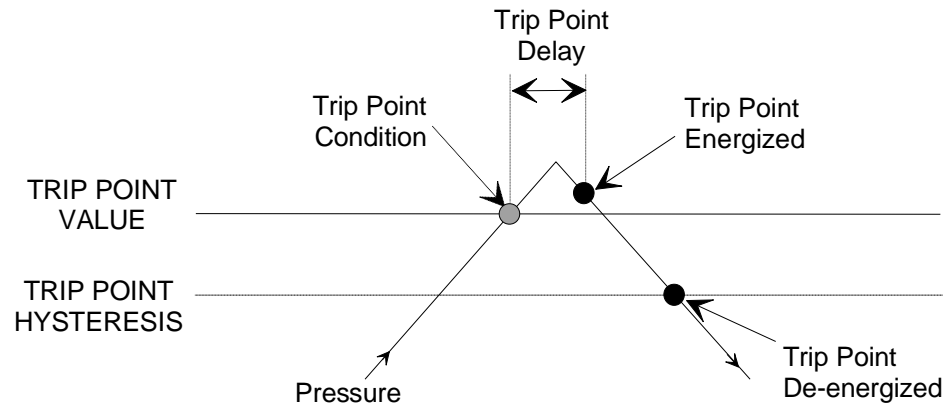

Figure 15: Trip Point Direction Set High

## **Setup**

Follow the guidelines described in *Chapter Two: Installation*, page 21, for instructions on installing your R700/R800 unit.

## **Cabling**

The pressure transducer has a 19 inch, permanently attached cable that connects the unit to the relay module. Refer to *Connections*, page 59, for a description of the 15-pin Type “D” connector on the relay module.

**Dimensions**

**Note**



All dimensions are listed in inches with millimeters referenced in parentheses. The tolerances for the dimensions are  $\pm 0.1$  (X.X) and  $\pm 0.01$  (X.XX).

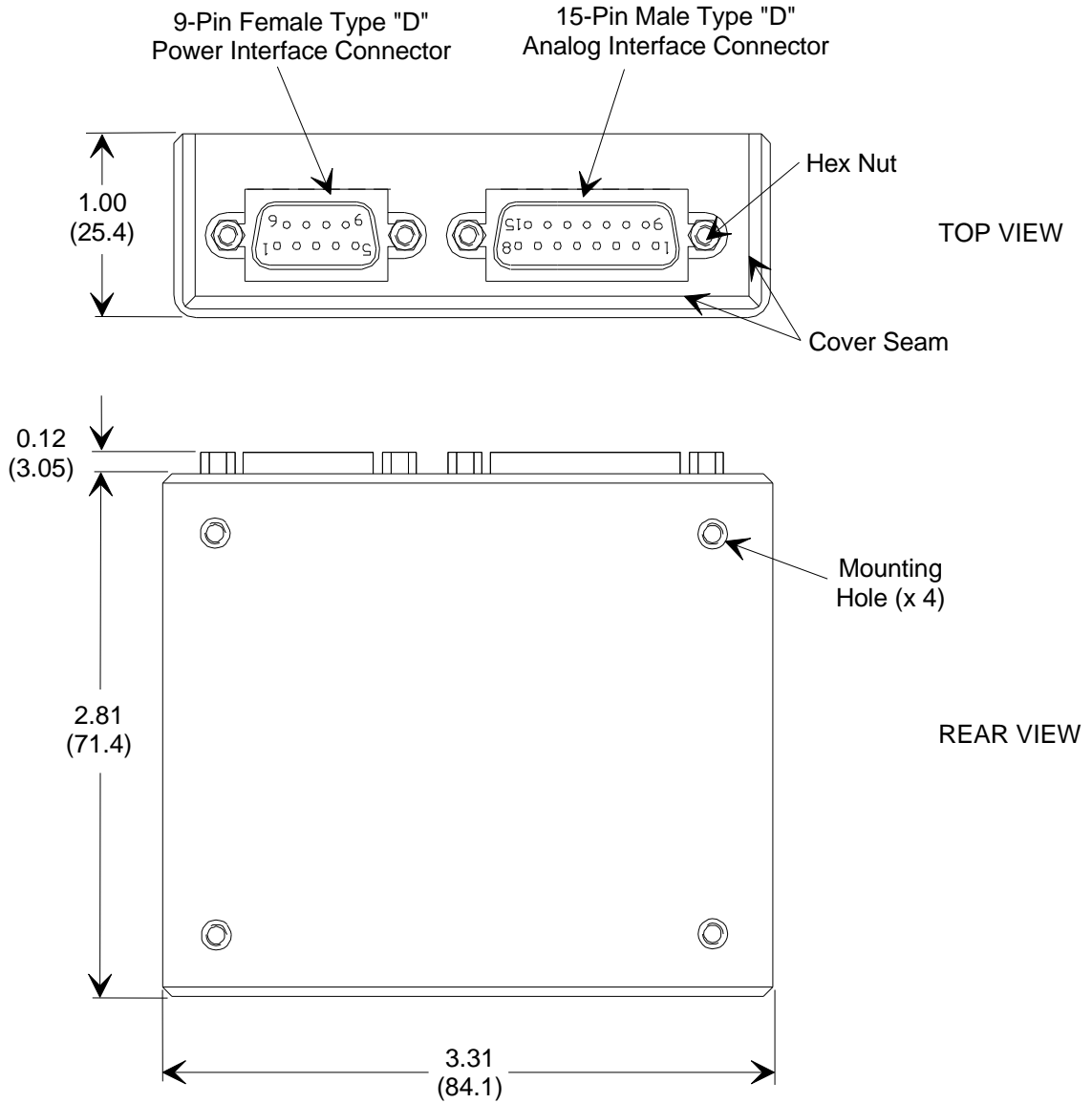

Figure 16: Dimensions of the Relay Module

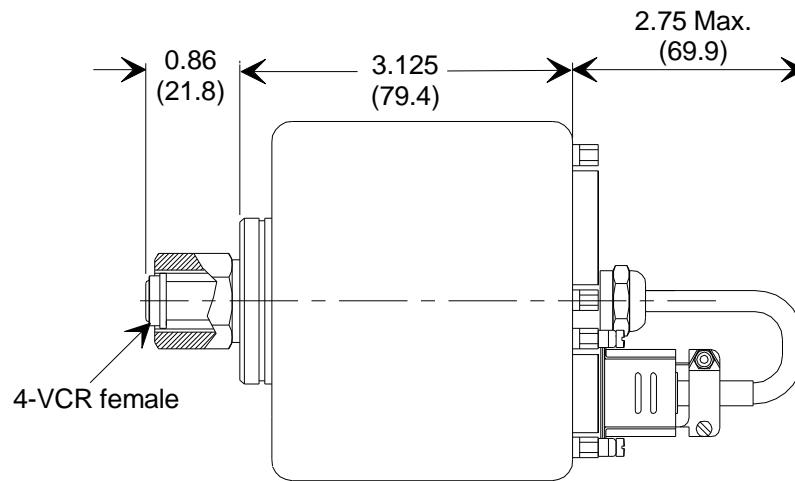

Figure 17: Top View of the Type R7xxC Unit

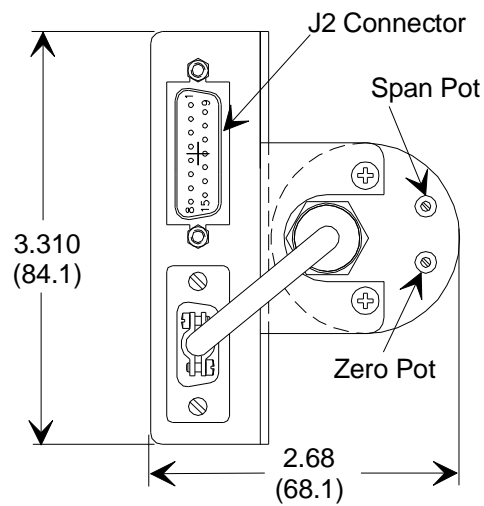

Figure 18: Side View of the Type R7xxC Unit

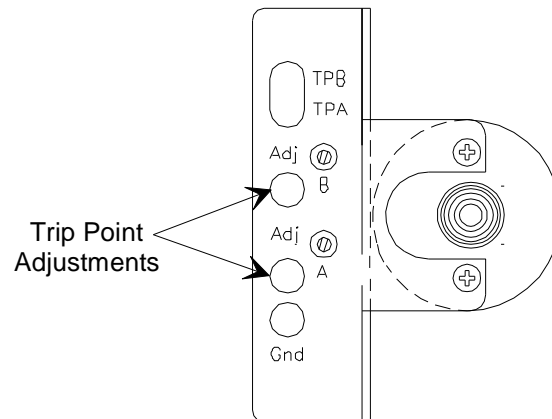

Figure 19: Location of the Trip Point Adjustments

## Mounting Instructions

### *How To Mount the Bracket onto the Relay Module*

1. Position the bracket over the rear panel of the Relay Module.  
Ensure that the holes in the large rectangular part of the bracket align with the mounting holes on the Relay Module (refer to Figure 16, page 55). Also, ensure that the small part of the bracket which is bent at a right angle is positioned at the top of the Relay Module so that it points *away* from the connectors.
2. Secure the bracket in place with the four (4) 4-40 pan head screws.

***How To Install the Relay Module onto your Transducer***

1. Remove the two (2) screws from the top of the transducer.  
Refer to Figure 20 for the location of the screws.

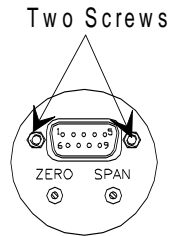

Figure 20: Screws on the Top of the Transducer

2. Position the Relay Module so that the holes in the right angle bend of the bracket line up with the screw holes on the transducer.
3. Replace the two (2) screws, removed in step 1, to secure the Relay Module to the transducer.
4. Attach the appropriate interface cable from the 9-pin female Type “D” connector on the Relay Module to the 9-pin male Type “D” male connector on the transducer.  
The interface cables are listed in Table 6, page 23.

## Electrical Information

### Connector

#### Note



The “Reserved” pin assignment refers to a pin with an internal connection which may be assigned a function in the future.

The relay module has a 15-pin Type “D” connector to interface to other devices. Connect the power supply to this connector.

Type R700/R800 Connector Pinout	
Pin Number	Assignment
1	Relay A Normally Open
2	Pressure Output
3	Reserved
4	Reserved
5	Power Return
6	-15 Volt
7	+15 Volt
8	Relay A Normally Closed
9	Relay B Normally Closed
10	Trip Point A Setting
11	Trip Point B Setting
12	Pressure Return
13	Relay B Normally Open
14	Relay B Common
15	Relay A Common

Table 22: Type R7xxC Connector Pinout

### Electrical Requirements

The R7xxC unit requires  $\pm 15$  Volts to power the relay module and the pressure transducer. To power the unit, connect the +15 V source to pin 7, the -15 V source to pin 6, and the power common to pin 5.

## Contact Rating

The contact rating for the relays is 30 Volts AC/DC @ 2 Amp resistive.

## How To Configure the Trip Points

To change the operation of a relay, that is, to select the pressure condition that will energize the relay, you must change its jumper setting on the PC board inside of the Relay Module. The Relay Module is enclosed in a two-piece cover that snaps together.

To access the PC board and adjust the trip point jumpers:

1. Disconnect the interface cable from the Relay Module and the transducer.
2. Remove the 2 hex nuts from the 9-pin Type “D” connector on the transducer and detach the Relay Module from the transducer.

It is not necessary to remove the bracket from the Relay Module.

3. Firmly grasp the Relay Module so that the rear panel of the unit faces up.
4. Insert a coin, flathead screwdriver, or the thumb nail of your other hand, at any point along the cover seam and gently bend the side of the bottom cover out.

Refer to Figure 16, page 55, for the location of the cover seam.

5. Gently lift the cover up and off of the unit.

The PC board is affixed to the inside of the front panel of the Relay Module and is visible as soon as the bottom cover is removed.

6. Locate the appropriate jumper(s) for the relay you want to change, and adjust the jumper(s) as required.

Refer to Figure 21, page 61, for information on the location and position of the jumpers.

7. Align the bottom cover so that the long edge and the side edges fit into the grooves on the inside of the front cover.

8. Press the unit to snap the two cover pieces together.

9. Reattach the Relay Module to the transducer.

Refer to *Setup*, page 54, for instructions.

10. Reconnect the interface cable removed in step 1.



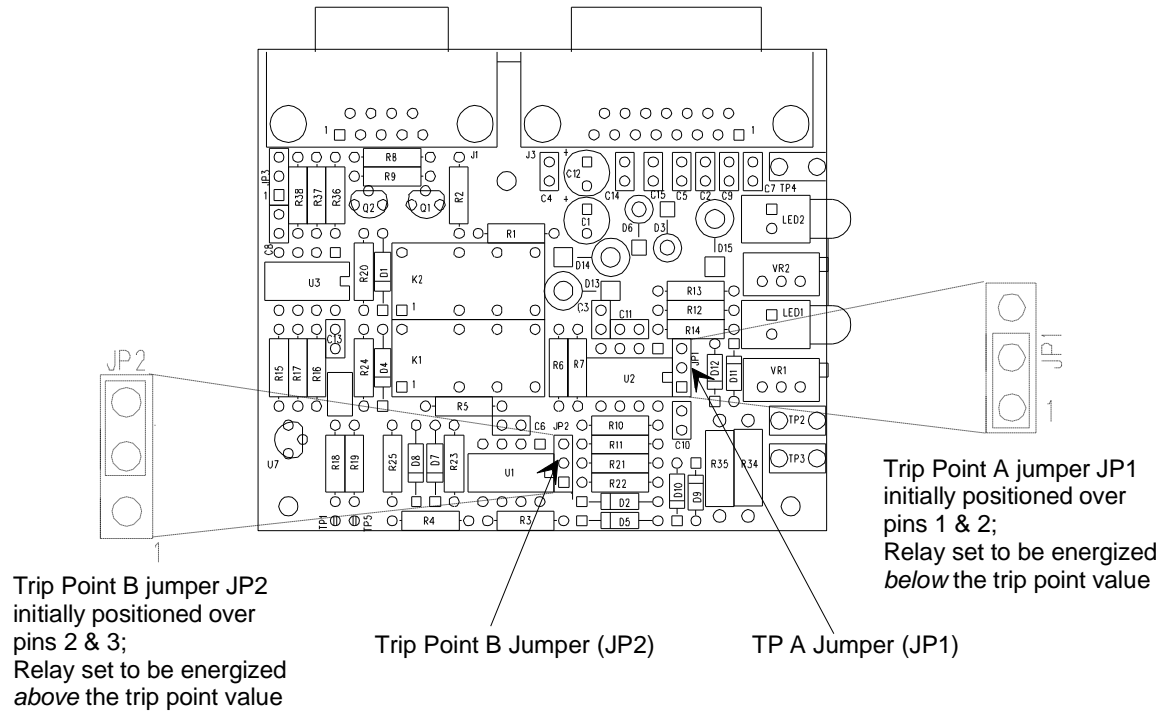

Figure 21: Relay Module PC Board

This page intentionally left blank.

## Chapter Six: Maintenance and Troubleshooting

### General

In general, no maintenance is required other than proper installation and operation, and an occasional zero adjustment. If a transducer fails to operate properly upon receipt, check for shipping damage, and check the power/signal cable for correct continuity. Any damage should be reported to the carrier and MKS Instruments immediately. If there is no obvious damage and the continuity is correct, obtain an RMA (Return Material Authorization) Number before returning the unit to MKS Instruments for service.

In production operations, verify the transducer zero (and adjust if necessary) each time the equipment is shut down for routine maintenance.

#### Note



---

The zero and trip point adjustments are the *only* adjustments that should usually be made in the field. Only adjust the span setting if you have access to proper calibration standards. Return the transducer to MKS Instruments for other adjustments, calibration, or servicing.

---

### Zero Adjustment

All pressure transducers require initial and periodic zero adjustments. Make these adjustments at a pressure *lower than* the transducer's minimum resolution to achieve the full dynamic range specified for the transducer. Refer to *How To Check the Transducer Zero*, page 41, for instructions on adjusting the zero setting.

## Troubleshooting

<b>Troubleshooting Chart</b>		
<b>Symptom</b>	<b>Possible Cause</b>	<b>Solution</b>
Overrange positive or negative signal	A shorted transducer or a damaged interconnect cable (transducer to electronics module).	Measure supply voltages at the connector. Inspect cable and transducer. Replace if necessary.
Measurement slowly goes positive over time	Overpressure and/or a build-up of contamination in the P <sub>x</sub> cavity.	Return to MKS for servicing or transducer replacement.
Unstable zero output	The ambient temperature may be too high. <i>or</i> The ambient temperature is varying over a wide range.	Refer to <i>Appendix A: Product Specifications</i> , page 65, and be sure the ambient temperature is within product requirements.

Table 23: Troubleshooting Chart

## Appendix A: Product Specifications

### 700 Series Specifications

Accuracy	1% of Reading
Ambient Operating Temperature Range	0° to 50° C (32° to 122° F)
Burst Pressure	10 times full scale or 1000 psia/g, whichever is greater; 5 times full scale to 3000 psia/g
CE Compliance <sup>1</sup>	EMC Directive 2004/108/EC
RoHS (Restriction of Hazardous Substances) Compliance	Fully compliant to Directive 2002/95/EC
Configuration	Single-ended or Flow-through
Fittings Flow-Through Single-Ended	¼" Tube; Swagelok® 4-VCR® fixed male ½ Tube; Swagelok 4-VCR male/female; Swagelok 8-VCR female; NW16-KF (up to 1200 Torr only)
Full Scale Pressure Ranges Absolute Gage Compound	10 Torr through 3000 psia 50 psig through 3000 psig 30-0-30 through 30-0-3000 inHg/psig
Input Required 0 to 5 Volt output  0 to 10 Volt output two wire 4 to 20 mA	10.8 VDC to +32 VDC (regulated if below 13 VDC) @ 10 mA max. +13 VDC to +32 VDC @ 10 mA max. 13 to 36 VDC excitation (32 maximum across the transducer)
Materials Exposed to Gas	Incoloy® and Inconel®. Some fittings may be made from 300-series stainless steel.
Non-incendive Approvals	NEC/NFPA70 Class I Division II, Groups A & B. Applies to 4-20 mA models only.
Output 0 to 5 VDC 0 to 10 VDC two wire 4 to 20 mA with 13 to 36 VDC excitation	into >10 K ohm load into >10 K ohm load into 0 to 900 ohm load, depending on excitation. See Figure 6, page 30. <i>Note:</i> 32 Volt maximum across the transducer.

<sup>1</sup> An overall metal braided shielded cable, properly grounded at both ends, is required during use.

Overpressure Limit	45 psia or 2 times full scale, whichever is greater
Temperature Coefficients	
Zero	0.02% of F.S./ °C
Span	0.04% of Rdg./ °C
Weight	
Flow-through	12.3 oz. (349 g)
Single-ended	< 10 oz. (< 283 g)

### Additional Specifications for the Type R7xxC Pressure Relay System

Contact Ratings	24 Volts AC/DC @ 1 Amp resistive
Dimensions	6.735" H x 3.31" L x 2.68" D (17.1 cm H x 8.4 cm L x 6.8 cm D)
Hysteresis	0.3% Full Scale, maximum
Input Required	±15 VDC ±5% @ <75 mA
LED Status	Green when energized No color when de-energized
Trip Point Action	User-selectable, either: Energized when the pressure is <i>above</i> the trip point <i>or</i> Energized when the pressure is <i>below</i> the trip point
Trip Point Setting Output	0 to 10 VDC (corresponding to 0 to 100% F.S.) for each trip point setting

Due to continuing research and development activities, these product specifications are subject to change without notice.

## Appendix B: Model Code Explanation

### General Description

The ordering code information is included in this section for reference only.

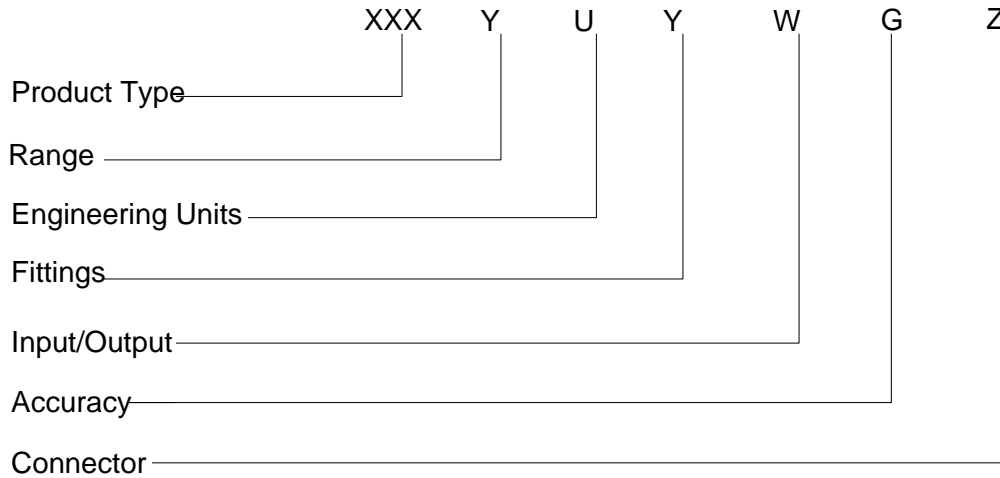

### **Product Type**

The 7xxC Series transducers covered in this manual include:

740C	R740C
742C	750C
R750C	752C

### Full Scale Range and Engineering Units

The full scale range is indicated by a two digit code. Ranges of 10 and above use the first digit to select the leading number of the range and the second digit selects the exponent. For example, the range code for a full scale of 1000 is 13. Only the 250 full scale uses a two letter designation since it requires two numbers to define the range. Refer to Table 24 for a list of the order codes for the full scale ranges.

<b>Full Scale Ordering Code</b>			
<b>Full Scale Range</b>	<b>Ordering Code</b>	<b>Full Scale Range</b>	<b>Ordering Code</b>
10	11	500	52
50	51	1000	13
100	12	2000	23
250	RD	3000	33

Table 24: Full Scale Range Ordering Code

The engineering unit is indicated by a one letter ordering code.

<b>Engineering Units Ordering Code</b>	
<b>Engineering Unit</b>	<b>Ordering Code</b>
Compound calibration (inHg/psi)	C
Pascal	L
millibar	M
Torr/mmHg	T
psi	P

Table 25: Engineering Units Ordering Code



Examples of Full Scale and Engineering Unit Ordering Codes					
700 Series				800 Series	
Gage	Ordering Code	Absolute	Ordering Code	Absolute	Ordering Code
50 psig	51P	10 Torr	11T	100 psia	12P
100 psig	12P	100 Torr	12T	250 psia	RDP
250 psig	RDP	1000 Torr	13T	1000 psia	13P
500 psig	52P	50 psia	51P	3000 psia	33P
1000 psig	13P	100 psia	12P		
2000 psig	23P	1000 psia	13P		
3000 psig	33P	3000 psia	33P		

Table 26: Examples of Full Scale and Engineering Unit Ordering Codes

### Fittings

The type of fittings used is designated by a two letter code. Other configurations are available. Minimum quantities may apply. See *Appendix A, Product Specifications*, page 65, for specific standard configurations for each model.

Fitting Ordering Code							
700 Single-Ended		700 Flow-Through					
FA	¼" NPT Female	BB	¼" Butt Weld				
FB	¼" NPT Male						
FE	⅛" NPT Male						
FF	⅛" NPT Female						
G A	NW-16-KF						

Table 27: Ordering Code for Fittings

### Input/Output Settings

Use this ordering code to select the desired input/output combination listed in Table 28.

<b>Input/Output Selection Ordering Code</b>		
<b>Input</b>	<b>Output</b>	<b>Ordering Code</b>
+13 to 32 VDC	0 to 10 VDC	2
+10.8 to 32 VDC	0 to 5 VDC	3
+13 to 36 VDC	4 to 20 mA (two wire)	4

Table 28: Input/Output Selection Ordering Code

### Accuracy

The accuracy of the 7xxC Series transducer is specified by a one letter ordering code.

<b>Accuracy Ordering Code</b>	
<b>Accuracy</b>	<b>Ordering Code</b>
1% of Reading	G

Table 29: Accuracy Ordering Code

## Connector

The 7xxC Series transducer can be equipped with the connectors listed in Table 30.

Connector Ordering Code	
Connector	Ordering Code
9-pin Type "D"	A
15-Pin High Density Type "D"	C
Bendix 4 Position PT02A8-4P, male (4 -20 mA on pins A and D; voltage output on pins B and C)	D
Flying Leads (refer to Table 12, page 36 for the pinout)	F
Bendix 4 Position (PT02A8-4P), male <i>only available with the 4 to 20 mA output option</i> (4 - 20 mA on pins A and B with B jumpered to D)	H
Flying Leads (different pinout, refer to Table 13, page 36)	L

Table 30: Connector Ordering Code

This page intentionally left blank.

## Index

### A

Accessories, optional, 22

### C

Cables, interface, 52

Compound calibration, 41–44

Connections, 29, 57

Connectors, 17, 33–36

    relay module option, 57

Customer support, 19

### D

Dimensions, 54

    relay module option, 53

### E

Electrical information, 32, 57, 63

Environmental requirements, 22

### F

Fittings, 17, 28

### G

Gauge units, 43, 44

### I

Interface cables, 52

Introduction, 17

### L

Line resistance, 30

Location, requirements, 22

### M

Maintenance, 61

Manual, organization, 18

Mounting information, 26

Mounting instructions

    relay module option, 55

### O

Optional accessories, 22

Output configuration, 17

### P

Pressure limit, 63

Pressure, lowest for control, 47

Pressure, lowest reading, 47

Product descriptions, 17

### R

Readout device, 22, 32, 45

Relay module

    mounting instructions, 55

Returning the product, 19

Rln. *See* Line resistance

RoHS (Restriction of Hazardous Substances), 17, 63

### S

Safety information, 1–16

Sensor operation, 45

Signal conditioner, 46

Span adjustment, 61

**T**

Transducer zero, 41–44

Trip point

    direction, 51

    jumpers, 58

Trip points, 17

Type R700/R800 Relay System

    cabling, 52

    connections, 57

    electrical, 57

    setup, 52

**U**

Ultraclean processing, 17

Unpacking, 21

**Z**

Zero adjustment, 61

Zero, checking, 41–44