



117082-P1
Rev D, 1/98
Instruction Manual

MKS Type 653B Exhaust Throttle Valve



WARRANTY

Type 653B Equipment

MKS Instruments, Inc. (**MKS**) warrants that for two years from the date of shipment the equipment described above (the "equipment") manufactured by **MKS** shall be free from defects in materials and workmanship and will correctly perform all date-related operations, including without limitation accepting data entry, sequencing, sorting, comparing, and reporting, regardless of the date the operation is performed or the date involved in the operation, provided that, if the equipment exchanges data or is otherwise used with equipment, software, or other products of others, such products of others themselves correctly perform all date-related operations and store and transmit dates and date-related data in a format compatible with **MKS** equipment. THIS WARRANTY IS **MKS'** SOLE WARRANTY CONCERNING DATE-RELATED OPERATIONS.

For the period commencing with the date of shipment of this equipment and ending two years later, **MKS** will, at its option, either repair or replace any part which is defective in materials or workmanship or with respect to the date-related operations warranty without charge to the purchaser. The foregoing shall constitute the exclusive and sole remedy of the purchaser for any breach by **MKS** of this warranty.

The purchaser, before returning any equipment covered by this warranty, which is asserted to be defective by the purchaser, shall make specific written arrangements with respect to the responsibility for shipping the equipment and handling any other incidental charges with the **MKS** sales representative or distributor from which the equipment was purchased or, in the case of a direct purchase from **MKS**, with the **MKS** home office in Andover, Massachusetts, USA.

This warranty does not apply to any equipment which has not been installed and used in accordance with the specifications recommended by **MKS** for the proper and normal use of the equipment. **MKS** shall not be liable under any circumstances for indirect, special, consequential, or incidental damages in connection with, or arising out of, the sale, performance, or use of the equipment covered by this warranty.

MKS recommends that all **MKS** pressure and flow products be calibrated periodically (typically every 6 to 12 months) to ensure accurate readings. When a product is returned to **MKS** for this periodic re-calibration it is considered normal preventative maintenance not covered by any warranty.

THIS WARRANTY IS IN LIEU OF ALL OTHER RELEVANT WARRANTIES, EXPRESSED OR IMPLIED, INCLUDING THE IMPLIED WARRANTY OF MERCHANTABILITY AND THE IMPLIED WARRANTY OF FITNESS FOR A PARTICULAR PURPOSE, AND ANY WARRANTY AGAINST INFRINGEMENT OF ANY PATENT.

MKS Type 653B Exhaust Throttle Valve

Please Note:

MKS Instruments provides these documents as the latest version for the revision indicated. The material is subject to change without notice, and should be verified if used in a critical application.

Copyright © 1998 by MKS Instruments, Inc.

All rights reserved. No part of this work may be reproduced or transmitted in any form or by any means, electronic or mechanical, including photocopying and recording, or by any information storage or retrieval system, except as may be expressly permitted in writing by MKS Instruments, Inc.

Printed in the United States of America

Baratron[®] is a registered trademark of MKS Instruments, Inc., Andover, MA

Chemraz[®] is a registered trademark of Greene, Tweed & Co., Inc., Kulpsville, PA

Viton[®] and Kalrez[®] are registered trademarks of DuPont Dow Elastomers, Inc., Wilmington, DE

Parker[®] is a registered trademark of Parker Seals, Lexington, KY

Table of Contents

Valve Safety Information	1
Symbols Used in This Instruction Manual.....	1
Symbols Found on the Unit	2
Safety Procedures and Precautions	3
Chapter One: General Information.....	5
Introduction	5
How This Manual is Organized.....	6
Customer Support.....	6
Chapter Two: Installation	7
How To Unpack the Type 653 Unit	7
Unpacking Checklist	7
Environmental Requirements	8
Setup	8
Choosing A Pressure Controller	9
Flange Types	9
ASA Series Flanges.....	10
CF Series Flanges.....	11
ISO-NW Series Flanges.....	12
JIS Series Flanges	13
KF Series Flanges	14
Interface Cables	15
Generic Shielded Cable Description	16
Interface Connector.....	17
Chapter Three: Operation	19
Theory of Operation.....	19
General Operation Information.....	20
Chapter Four: Maintenance	21
General Information.....	21

Table of Contents

Safety Precautions	21
Cleaning the Valve	22
Appendix A: Product Specifications.....	23
General Specifications	23
Appendix B: ASA Series Flange Specifications	25
Appendix C: ISO-NW Series Flange Specifications	27
Appendix D: CF Series Flange Specifications	29
Appendix E: JIS Series Flange Specifications	31
Index	33

List of Figures and Tables

Figures

Figure 1: Outline Dimensions of the Motor Driver Assembly	9
Figure 2: Outline Dimensions of an ASA Series Flange.....	10
Figure 3: Outline Dimensions of a CF Series Flange	11
Figure 4: Outline Dimensions of an ISO-NW Series Flange	12
Figure 5: Outline Dimensions of a JIS Series Flange	13
Figure 6: Outline Dimensions of a KF Series Flange	14

Tables

Table 1: Definition of Symbols Found on the Unit	2
Table 2: Size Options for ASA Series Flanges.....	10
Table 3: Size Options for CF Series Flanges.....	11
Table 4: Size Options for ISO-NW Series Flanges.....	12
Table 5: Size Options for JIS Series Flanges.....	13
Table 6: Size Options for KF Series Flanges.....	14
Table 7: Interface Cables	15
Table 8: Interface Connector Pinout	17

Valve Safety Information

Symbols Used in This Instruction Manual

Definitions of WARNING, CAUTION, and NOTE messages used throughout the manual.

Warning

The **WARNING** sign denotes a hazard to personnel. It calls attention to a procedure, practice, condition, or the like, which, if not correctly performed or adhered to, could result in injury to personnel.

Caution

The **CAUTION** sign denotes a hazard to equipment. It calls attention to an operating procedure, practice, or the like, which, if not correctly performed or adhered to, could result in damage to or destruction of all or part of the product.

Note

The **NOTE** sign denotes important information. It calls attention to a procedure, practice, condition, or the like, which is essential to highlight.

Symbols Found on the Unit

The following table describes symbols that may be found on the unit.















Definition of Symbols Found on the Unit			
			
On (Supply) IEC 417, No.5007	Off (Supply) IEC 417, No.5008	Earth (ground) IEC 417, No.5017	Protective earth (ground) IEC 417, No.5019
			
Frame or chassis IEC 417, No.5020	Equipotentiality IEC 417, No.5021	Direct current IEC 417, No.5031	Alternating current IEC 417, No.5032
			
Both direct and alternating current IEC 417, No.5033-a	Class II equipment IEC 417, No.5172-a	Three phase alternating current IEC 617-2 No.020206	
			
Caution, refer to accompanying documents ISO 3864, No.B.3.1	Caution, risk of electric shock ISO 3864, No.B.3.6	Caution, hot surface IEC 417, No.5041	

Table 1: Definition of Symbols Found on the Unit

Safety Procedures and Precautions

Observe the following general safety precautions during all phases of valve operation. Failure to comply with these precautions or with specific warnings elsewhere in this manual violates safety standards of intended use of the valve and may impair the protection provided by the equipment. MKS Instruments, Inc. assumes no liability for the customer's failure to comply with these requirements.

Warning



Moving parts in the valve create a risk of personal injury until the valve is securely incorporated into a system. To avoid injury, keep all bodily parts away from any valve opening.

- 1. Do not insert objects into openings where contact with moving parts is possible.**
 - 2. Isolate the valve from any electrical or pneumatic power supply before handling the valve.**
-

DO NOT SUBSTITUTE PARTS OR MODIFY VALVE

Do not install substitute parts or perform any unauthorized modification to the valve. Return the valve to an MKS Calibration and Service Center for service and repair to ensure that all safety features are maintained.

SERVICE BY QUALIFIED PERSONNEL ONLY

Operating personnel must not attempt component replacement and internal adjustments. Any service must be performed by qualified service personnel only.

USE CAUTION WHEN OPERATING WITH HAZARDOUS MATERIALS

If hazardous materials are used, observe the proper safety precautions, completely purge the valve when necessary, and ensure that the material used is compatible with the wetted materials in this product, including any sealing materials.

PURGE THE VALVE

After installing the unit, or before removing it from a system, purge the unit completely with a clean, dry gas to eliminate all traces of the previously used flow material.

USE PROPER PROCEDURES WHEN PURGING

This valve must be purged under a ventilation hood, and gloves must be worn for protection.

DO NOT OPERATE IN AN EXPLOSIVE ENVIRONMENT

To avoid explosion, do not operate this product in an explosive environment unless it has been specifically certified for such operation.

USE PROPER FITTINGS AND TIGHTENING PROCEDURES

All valve fittings must be consistent with valve specifications, and compatible with the intended use of the valve. Assemble and tighten fittings according to manufacturer's directions.

CHECK FOR LEAK-TIGHT FITTINGS

Carefully check all vacuum component connections to ensure leak-tight installation.

OPERATE AT SAFE INLET PRESSURES

Never operate the valve at pressures higher than the rated maximum pressure (refer to the product specifications for the maximum allowable pressure).

INSTALL A SUITABLE BURST DISC

When operating from a pressurized gas source, install a suitable burst disc in the vacuum system to prevent system explosion should the system pressure rise.

KEEP THE UNIT FREE OF CONTAMINANTS

Do not allow contaminants to enter the unit before or during use. Contamination such as dust, dirt, lint, glass chips, and metal chips may permanently damage the unit or contaminate the process.

KEEP AWAY FROM VALVE OPENING

Keep fingers, other body parts, and other materials away from the valve opening when the valve is in operation.

Chapter One: General Information

Introduction

The Type 653B Exhaust Throttle Valve is designed for a wide range of pressure control conductance and has the high torque rating necessary for sealing-type and large-size valves. The 653's motor and gear/driver assembly combined with the Type 651, Type 1651 or Type 652B Self-Tuning Controller, provides fast and precise pressure control over the entire operating range of the valve. High accuracy control is attained by micro-stepping the flapper to give more precise control of the pressure at the desired pressure set point without drift around the set point.

The Type 653 valve has a torque reserve exceeding that which is required to operate a 4-inch sealing valve or a 12-inch non-sealing valve and is constructed of corrosion-resistant 316L sst. The valve body can be heated up to 150° C (using the appropriate sealing material) without damaging the motor or drive assembly, thereby allowing for operation in high-temperature applications and processes. Heating the valve, along with the high torque and corrosion resistant material of the 653 valve, prevents condensation and deposit buildup that can occur in some of the most demanding and dirty processes.

The 653 valve has a flapper position indicator to identify valve angle during system troubleshooting operations. The indicator also acts as a mechanical stop to prevent the flapper from traveling beyond normal open and closed positions. The Type 653 valve is available in most common flange styles (ASA, CF, ISO-NW, JIS and KF) to ensure that mating with existing hardware is an easy operation.

How This Manual is Organized

This manual is designed to provide information and instructions in the proper installation, operation, and maintenance of the MKS Type 653 valve.

Before installing your valve in a system and/or operating it, carefully read and familiarize yourself with all precautionary notes in the *Safety Messages and Procedures* section at the beginning of this manual. In addition, observe and obey all WARNING and CAUTION notes provided throughout the manual.

Chapter One, *General Information*, (this chapter) introduces the product.

Chapter Two, *Installation*, explains the environmental requirements and describes how to mount the valve in your system.

Chapter Three, *Operation*, describes how to use the valve and explains all its features.

Chapter Four, *Maintenance* provides instructions on how to clean the valve.

Appendix A, *Product Specifications*, lists the specifications of the valve.

Appendices B through E, contain the *Flange Specifications*.

Customer Support

Standard maintenance and repair services are available at all of our regional MKS Calibration and Service Centers, listed on the back cover. In addition, MKS accepts the instruments of other manufacturers for recalibration using the Primary and Transfer Standard calibration equipment located at all of our regional service centers. Should any difficulties arise in the use of MKS instruments, or to obtain information about companion products MKS offers, contact any authorized MKS Calibration and Service Center. If it is necessary to return an instrument to MKS, please obtain an ERA Number (Equipment Return Authorization Number) from the MKS Calibration and Service Center before shipping. The ERA Number expedites handling and ensures proper servicing of your instrument.

Please refer to the inside of the back cover of this manual for a list of MKS Calibration and Service Centers.

Warning



All returns to MKS Instruments must be free of harmful, corrosive, radioactive, or toxic materials. The Type 653 valve, in particular, *must* be purged of all contaminants.

Chapter Two: Installation

How To Unpack the Type 653 Unit

MKS has carefully packed the Type 653 unit so that it will reach you in perfect operating order. Upon receiving the unit, however, you should check for defects, cracks, broken connectors, etc., to be certain that damage has not occurred during shipment.

Note

Do *not* discard any packing materials until you have completed your inspection and are sure the unit arrived safely.

If you find any damage, notify your carrier and MKS immediately. If it is necessary to return the unit to MKS, obtain an ERA Number (Equipment Return Authorization Number) from the MKS Service Center before shipping. Please refer to the inside of the back cover of this manual for a list of MKS Calibration and Service Centers.

Unpacking Checklist

Standard Equipment:

- Type 653 Unit
- Type 653 Instruction Manual (this book)

Environmental Requirements

The following temperature requirements should be adhered to when installing and using a Type 653 valve.

- Standard operating temperature of the valve body is in the range of 0° to 100° C
The Type 653 valve is optionally available for operation in temperatures of 0° to 150° C¹
- The valve motor ambient operating temperature ranges from -20° to +40° C

For general requirements of the Type 653 valve, refer to Appendix A, *Product Specifications*, page 23. Specific requirements of the available flange types are provided in Appendices B through E, on pages 25 through 31.

Setup

MKS products are designed and tested to provide the highest degree of safety attainable. To use your MKS valve safely, you must always conform to the following instructions:

Warning



The moving parts in the valve create a risk of personal injury until the valve is securely incorporated into a system. To avoid injury keep all objects away from any valve opening.

- Do not insert objects into openings where contact with moving parts is possible.
- Isolate the equipment from any electrical or pneumatic power supply before handling the valve.

The Type 653 valve may be mounted in any position, but the PUMP label must be oriented toward the pump. Provide proper clearances for valve removal, as routine cleaning may be necessary due to buildup of process contaminants. Refer to Figure 1, page 9, for outline dimensions of the valve.

Note



All dimensions listed in this manual are referenced in inches with the equivalent units of measure (mm) listed in parenthesis.

¹Consistent with shaft seal and flapper seal O-ring material.

Choosing A Pressure Controller

The 653 valve works with the following pressure controllers:

- Type 651 (any revision)
- Type 1651 (any revision)
- Type 652 (Revision B or later)

Note



Revision A of the 652 controller *does not support* the 653 valve.

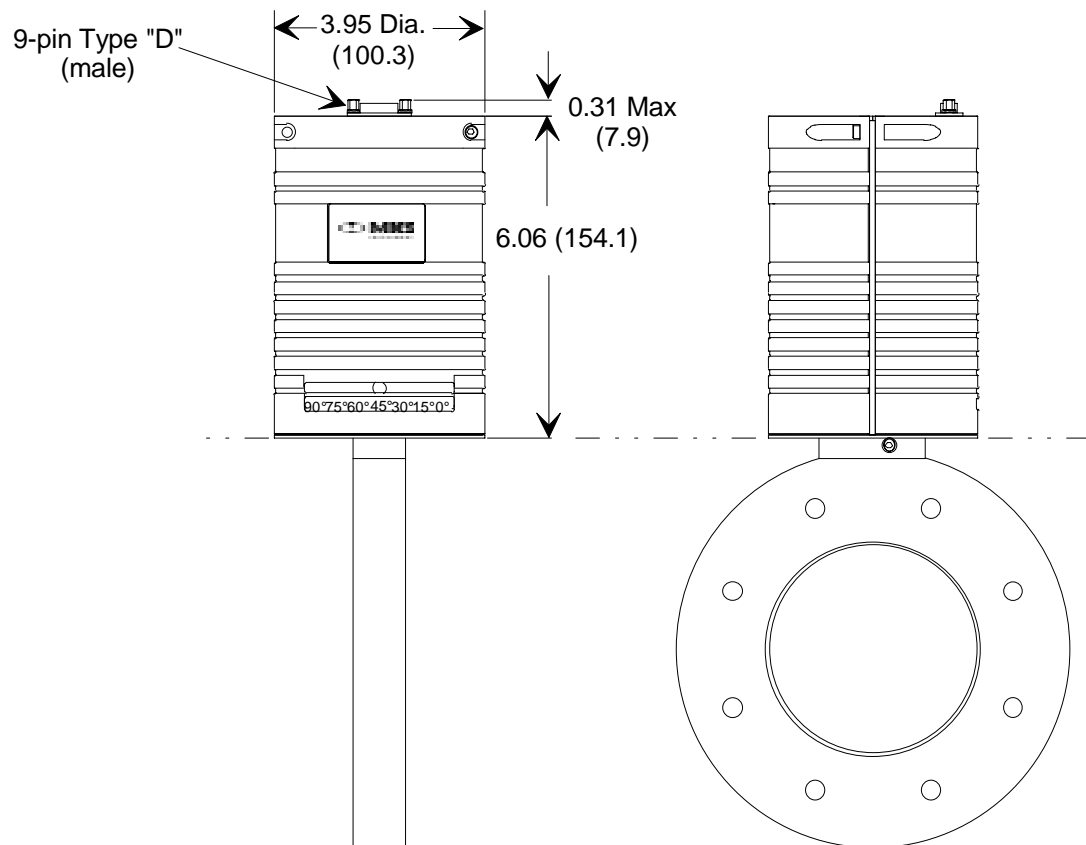

Figure 1: Outline Dimensions of the Motor Driver Assembly

Flange Types

The 653 valve has available five series of flange types: ASA, CF, ISO-NW, JIS, and KF. Refer to the appropriate tables and outline drawings on the following pages for information about the various flange types.

ASA Series Flanges

Model No.	A	B	C	E	F	G	H	J O-Ring Groove			O-Ring Size	L	Total Height
								ID	Width	Depth			
653 -2-2-1 -2-2-2	1.886 (48)	5.95 (151)	6.16 (156.6)	.75 (19)	4	4.750 (121)	45°	3.365 (85)	.185 (4.7)	.112 (2.8)	2-237	1.00 (25)	12.22 (310)
653 -60-2-2 -60-2-1	2.360 (60)												
653 -3-2-1 -3-2-2	2.886 (74)												
653 -3-3-1 -3-3-2	2.886 (73)	7.40 (188)	7.65 (194.3)	.75 (19)	4	6.000 (152)	45°	4.475 (114)	.285 (7.2)	.172 (4.4)	2-349	13.71 (348)	
653 -4-3-1 -4-3-2	3.885 (99)												
653 -4-4-1 -4-4-2	3.885 (99)	8.90 (226)	9.17 (233.0)	.75 (19)	8	7.500 (191)	22.5°	5.995 (152)	.175 (4.4)	.100 (2.5)	2-258	15.23 (387)	
653 -6-4-2	5.503 (140)		9.79 (249)			7.500 (190)		5.995 (152)					
653 -6-6-2	5.869 (149)	10.90 (277)	11.81 (300)	.88 (22)	8	9.500 (241)	22.5°	8.000 (203)	.175 (4.4)	.100 (2.5)	2-266	17.87 (454)	
653 -8-6-2	7.636 (194)												
653 -8-8-2	7.636 (194)	13.19 (335)	14.11 (358)	.88 (22)	8	11.750 (298)	22.5°	9.750 (248)	.175 (4.4)	.100 (2.5)	2-273	20.17 (512)	
653 -10-10-2	10.118 (257)												
653 -10-10-2	10.118 (257)	16.00 (406)	16.94 (430)	1.00 (25)	12	14.250 (362)	15°	11.938 (303)	.185 (4.7)	.112 (2.8)	2-278	1.62 (41)	23.0 (584)

Table 2: Size Options for ASA Series Flanges

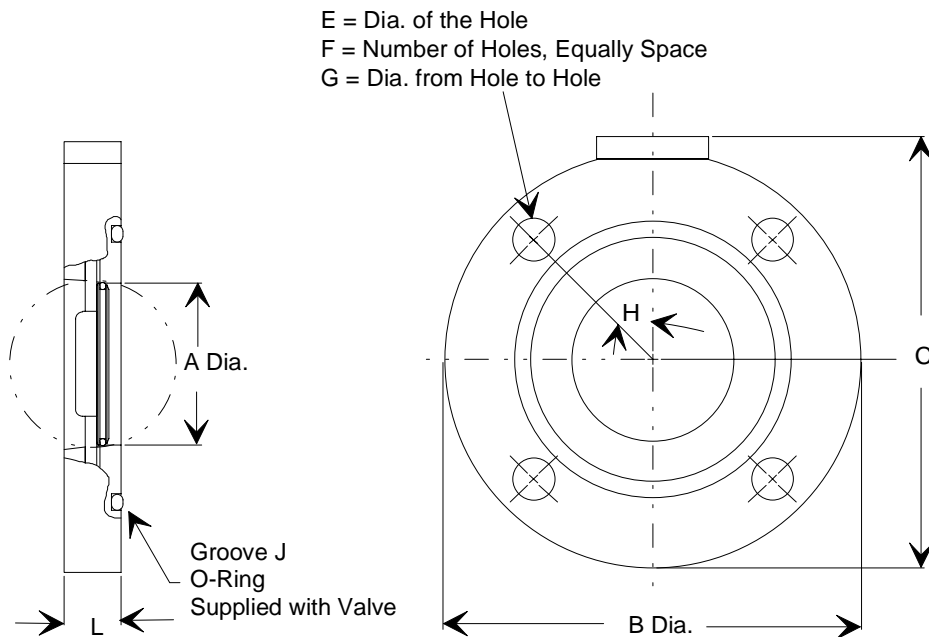

Figure 2: Outline Dimensions of an ASA Series Flange

CF Series Flanges

Model No.	A	B	C	E	F	G	H	K CF Size	L	Total Height
653 -1-2CF-1 -1-2CF-2	1.270 (32)	2.75 (70)	4.18 (106)	.27 (6.8)	6	2.312 (59)	30°	2-3/4"	1.00 (25)	10.24 (260)
653 -2-2CF-1 -2-2CF-2	.779 (20)									
653 -2-3CF-1 -2-3CF-2	1.886 (48)	3.25 (83)	4.68 (119)	.34 (8.6)	8	2.850 (72)	22°30'	3-3/8"		10.74 (273)
653 -2-4CF-1 -2-4CF-2	1.886 (48)	4.47 (114)	5.91 (150)			3.628 (92)		4-1/2"		11.97 (304)
653 -3-6CF-1 -3-6CF-2	2.886 (73)	7.40 (188)	7.70 (196)	.33 (8.4)	16	5.128 (130)	11°15'	6"		13.76 (350)
653 -4-6CF-1 -4-6CF-2	3.885 (99)									
653 -6-8CF-2	5.869 (149)	8.90 (226)	10.76 (273)		20	7.128 (181)	9°	8"	1.62 (41)	16.82 (427)
653 -8-10CF-2	7.650 (194)	11.22 (285)	12.53 (318)		24	9.128 (232)	7.5°	10"		18.59 (472)

Table 3: Size Options for CF Series Flanges

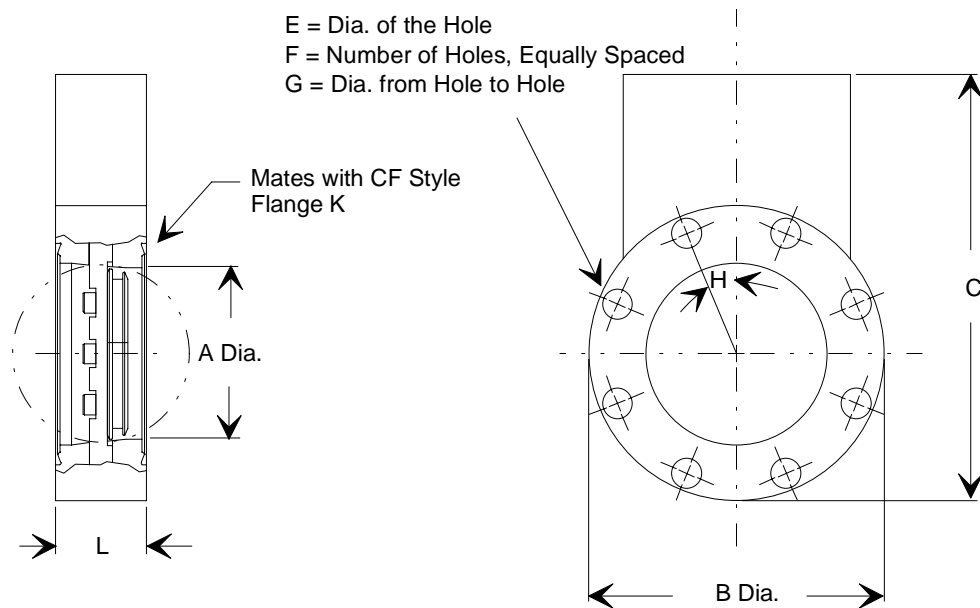

Figure 3: Outline Dimensions of a CF Series Flange

ISO-NW Series Flanges

Model No.	A	B	C	E	F	G	H	K	L	Total Height				
653 -60-63-1 653 -60-63-2	2.360 (60)	5.95 (151)	6.16 (157)	0.35 (9)	4	4.330 (110)	45°	NW-63	100 (25)	12.22 (310)				
653 -3-80-1 653 -3-80-2	2.886 (73)	5.95 (151)	6.16 (157)							8	4.920 (125)	22.5°	NW-80	12.22 (310)
653 -4-100-1 653 -4-100-2	3.885 (99)	7.40 (188)	7.65 (194)											5.710 (145)
653 -6-160-2	5.869 (149)	8.90 (22.6)	9.79 (249)	0.43 (11)	12	10.240 (260)	15°	1.62 (41)	15.85 (403)					
653 -8-200-2	7.650 (194)	11.22 (285)	12.13 (308)						12.200 (310)	NW-250	18.19 (462)			
653 -10-250-2	9.700 (246)	13.19 (335)	14.11 (358)								15.550 (395)	NW-320	20.17 (512)	
653 -12-320-2	12.370 (314)	16.73 (425)	17.67 (449)						0.55 (14)	23.73 (603)				

Table 4: Size Options for ISO-NW Series Flanges

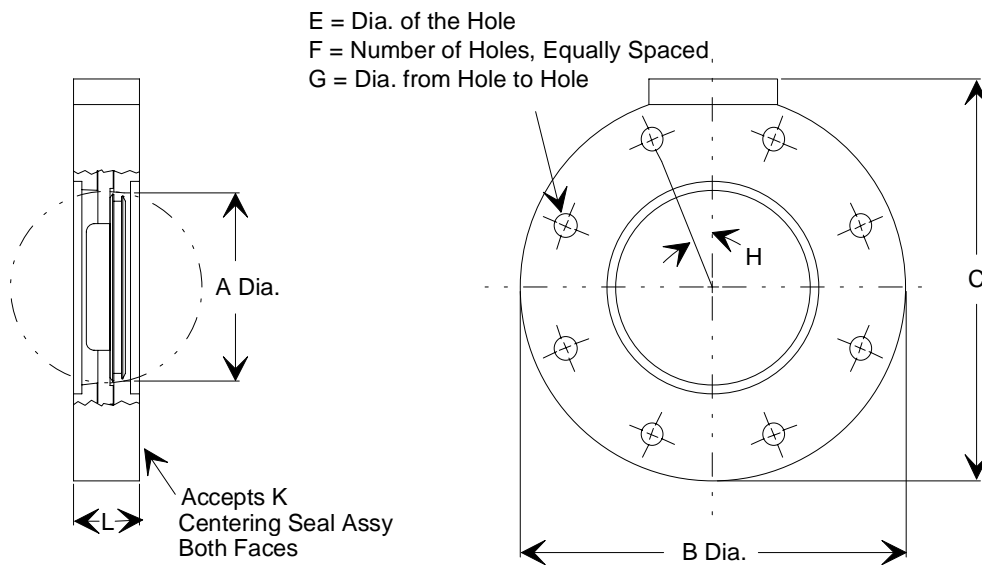

Figure 4: Outline Dimensions of an ISO-NW Series Flange

JIS Series Flanges

Model No.	A	B	C	E	F	G	H	J O-Ring Groove			O-Ring Size	K	L	Total Height
								I.D.	Width	Depth				
653 -2-50J-1 653 -2-50J-2	1.886 (48)	4.47 (114)	5.906 (150)	0.39 (10)	4	3.937 (100)	45°	2.766 (70)	0.197 (5)	0.118 (3)	2.756 x 0.157 (70 x 4)	JIS 50MM	1.00 (25)	11.97 (30.4)
653 -3-80J-1 653 -3-80J-2	2.886 (73)	6.299 (160)	6.524 (166)	0.472 (12)		5.315 (135)								3.937 (100)
653 -4-100J-1 653 -4-100J-2	3.885 (99)	7.28 (185)	7.53 (191)	0.590 (15)	8	6.299 (160)	22.5°	8.858 (225)	0.315 (8)	0.177 (4.5)	0.236 x 8.760 (6 x 222.5)	JIS 100MM	13.59 (345)	
653 -6-150J-2	5.709 (145)	9.25 (235)	10.14 (258)			8.268 (210)								6.890 (175)
653 -8-200J-2	7.677 (195)	11.81 (300)	12.72 (323)	10.630 (270)	8.858 (225)	12	12.598 (320)	14.566 (370)	12.795 (325)	0.236 x 12.658 (6 x 321.5)	JIS 200MM	18.78 (477)		
653 -10-250J-2	9.645 (244.9)	13.78 (350)	14.71 (374)	12.598 (320)	14.566 (370)								15°	10.827 (275)
653 -12-300J-2	11.597 (294.5)	15.75 (400)	16.68 (424)	12.598 (320)	14.566 (370)	15°	10.827 (275)	12.795 (325)	0.236 x 12.658 (6 x 321.5)	JIS 300MM	22.74 (578)			

Table 5: Size Options for JIS Series Flanges

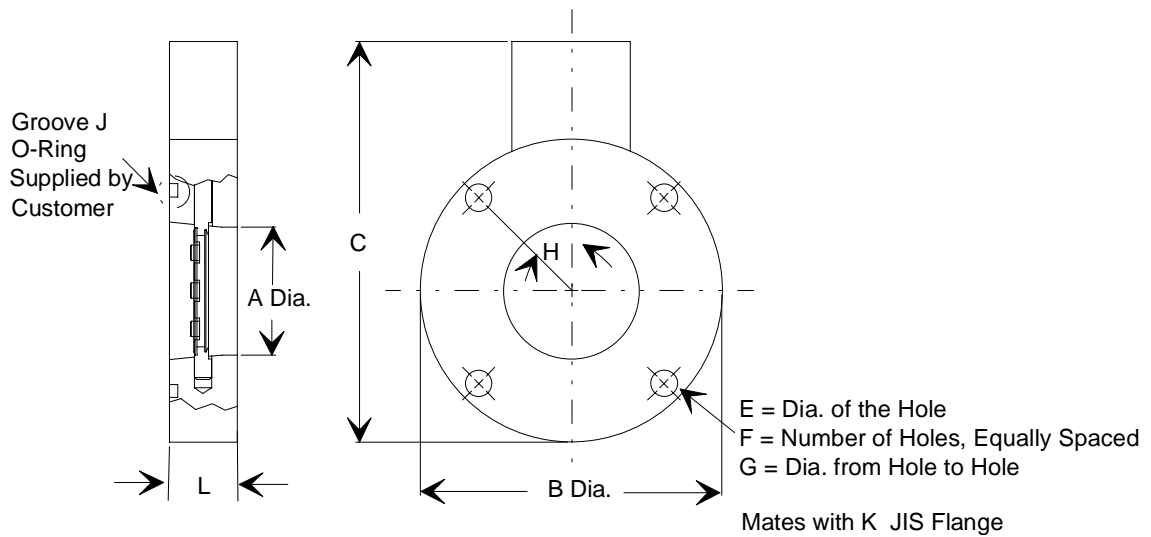

Figure 5: Outline Dimensions of a JIS Series Flange

KF Series Flanges

Model No.	A ₁	A ₂	B	C	D	E	F	Total Height
653 -20-40-1 -20-40-2	0.870 (22)	0.779 (20)	2.75 (70)	2.16 (55)	1.25 (32)	2.25 (57)	KF-40	10.25 (260)
653 -1-40-1 -1-40-2	1.385 (35)	1.270 (32)						
653 -2-50-1 -2-50-2	2.998 (51)	1.886 (48)	3.25 (83)	2.95 (75)	1.00 (25)	2.00 (51)	KF-50	10.75 (273)

Table 6: Size Options for KF Series Flanges

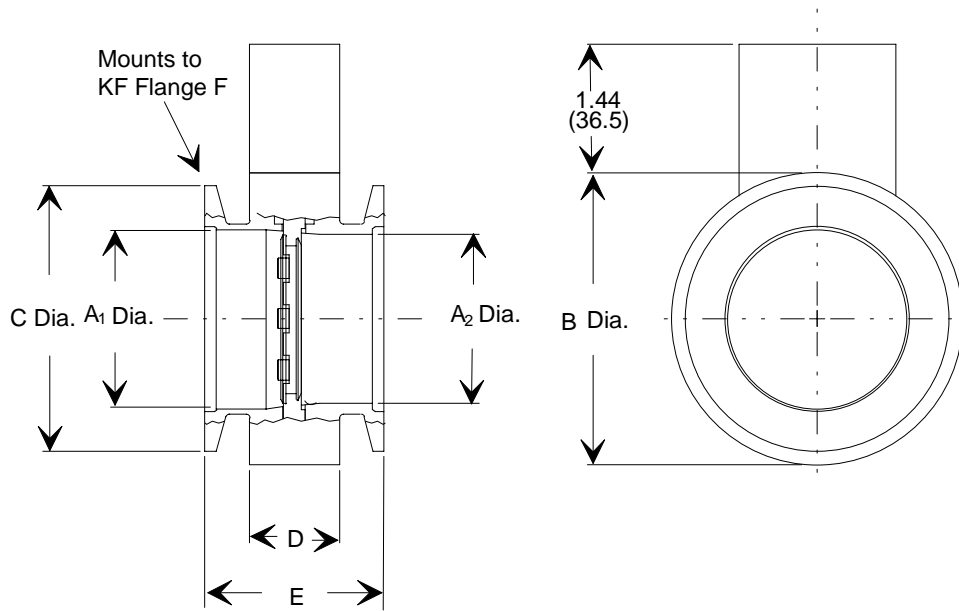

Figure 6: Outline Dimensions of a KF Series Flange

Interface Cables

As of January 1, 1996, most products shipped to the European Community must comply with the EMC Directive 89/336/EEC, which covers radio frequency emissions and immunity tests. In addition, as of January 1, 1997, some products shipped to the European Community must also comply with the Product Safety Directive 92/59/EEC and Low Voltage Directive 73/23/EEC, which cover general safety practices for design and workmanship. MKS products that meet these requirements are identified by application of the CE Mark.

To ensure compliance with EMC Directive 89/336/EEC, an overall metal braided shielded cable, properly grounded at both ends, is required during use. No additional installation requirements are necessary to ensure compliance with Directives 92/59/EEC and 73/23/EEC.

Note



1. An overall metal braided, shielded cable, properly grounded at both ends, is required during use to meet CE specifications.
2. To order an overall metal braided shielded cable, add an “S” after the cable type designation. For example, to order a cable to connect an MKS controller, use part number CB652-1-XX, where XX designates the cable length; for a braided, shielded cable use part number CB652S-1-XX.

Interface Cables	
MKS Controller	Cable Number
651, 1651, 652 (Rev B or later)	CB652-1-xx, CB652S-1-xx
<i>where X indicates the length of the cable, in feet</i>	

Table 7: Interface Cables

Generic Shielded Cable Description

Should you choose to manufacture your own cables, follow the guidelines listed below:

1. The cable must have an overall metal *braided* shield, covering all wires. Neither aluminum foil nor spiral shielding will be as effective; using either may nullify regulatory compliance.
2. The connectors must have a metal case which has direct contact to the cable's shield on the whole circumference of the cable. The inductance of a flying lead or wire from the shield to the connector will seriously degrade the shield's effectiveness. The shield should be grounded to the connector before its internal wires exit.
3. With very few exceptions, the connector(s) must make good contact to the device's case (ground). "Good contact" is about 0.01 ohms; and the ground should surround all wires. Contact to ground at just one point may not suffice.
4. For shielded cables with flying leads at one or both ends; it is important at each such end, to ground the shield *before* the wires exit. Make this ground with absolute minimum length. (A ¼ inch piece of #22 wire may be undesirably long since it has approximately 5 nH of inductance, equivalent to 31 ohms at 1000 MHz). After picking up the braid's ground, keep wires and braid flat against the case. With very few exceptions, grounded metal covers are not required over terminal strips. If one is required, it will be stated in the Declaration of Conformity or in the instruction manual.
5. In selecting the appropriate type and wire size for cables, consider:
 - A. The voltage ratings.
 - B. The cumulative I^2R heating of all the conductors (keep them safely cool).
 - C. The IR drop of the conductors, so that adequate power or signal voltage gets to the device.
 - D. The capacitance and inductance of cables which are handling fast signals, (such as data lines or stepper motor drive cables).
 - E. That some cables may need internal shielding from specific wires to others; please see the instruction manual for details regarding this matter.

Interface Connector

The pinout of the 9 -pin Type “D” Interface connector is shown in Table 8.

Interface Connector Pinout	
Pin Number	Signal
1	Motor Winding A
2	Motor Winding A'
3	Limit Switch Common
4	Open Limit Switch
5	Closed Limit Switch
6	Motor Winding B
7	Motor Winding B'
8	Limit Switch Current Source
9	No Connection

Table 8: Interface Connector Pinout

The limit switches require 25 mA current. For proper operation, use a +15 VDC power supply run through a 470 ohm, 0.5 Watt resistor.

To set up the Type 651, 1651, or 652B pressure controller, refer to the corresponding instruction manual.

This page intentionally left blank.

Chapter Three: Operation

Theory of Operation

The 653 Exhaust Throttle Valve is one of three components in a closed loop, downstream pressure control system. When coupled with a smart self tuning controller, such as the 651 controller, and a high accuracy Baratron[®] capacitance manometer, the 653 valve provides fast, reproducible set point control. The Baratron senses the chamber pressure which is then compared to the desired set point pressure in the pressure controller. The pressure controller commands the valve to open or close, thereby adjusting the chamber pressure to the desired process pressure set point.

Throttle valves, such as the 653 valve, provide:

- Good control over a wide dynamic range
- High conductance
- Fast response

Using the Type 651, 1651, or 652 pressure controller in conjunction with the 653 valve has another advantage. The flow rate of the 653 valve, like all throttle valves, is non-linear with respect to position; that is, the percent change in flow rate ranges from very large values when the valve is near the closed position, to zero when the valve is near the fully open position. Due to this large change in transfer characteristic, gain and phase lead must be reset each time a valve operates at a different position (to achieve optimum performance). The 651 and 652 self-tuning pressure controllers alleviate this situation with the use of a special software algorithm designed to compensate for the non-linearity in the valve.

Note

Revision A of the 652 controller *does not support* the 653 valve. Your 652 pressure controller must be at Revision B or later.

General Operation Information

The Type 653 valve is controlled by the Type 651, 1651, or 652B pressure controller, and instructions for operation are included in those manuals. There is no warm-up time required for the valve.

Caution



To avoid unstable pump performance when operating the 653 valve with high vacuum diffusion pumps, make certain the pressure above the oil vapor jet *does not* exceed 0.5 mTorr. If the pressure *does* exceed 0.5 mTorr, the pump's oscillation will appear to be an unstable control loop. If this occurs, lower the flow rates to ensure that the diffusion pump can operate in its correct pressure range.

Chapter Four: Maintenance

General Information

Any difficulties encountered in the use of valves are generally caused by process chemistry, contamination of wetted parts, or mechanical wear. Should unacceptable performance result, it is recommended that you contact an MKS Service Center for repair instructions.

Warning



All returns to MKS Instruments must be free of harmful, corrosive, radioactive, or toxic materials. The Type 653 valve, in particular, *must* be purged of all contaminants.

Safety Precautions

MKS products are designed and tested to provide the highest degree of safety attainable. To use your MKS valve safely, you must always conform to the following instructions:

Warning



The moving parts in the valve create a risk of personal injury until the valve is securely incorporated into a system. To avoid injury keep all objects away from any valve opening.

- Do not insert objects into openings where contact with moving parts is possible.
- Isolate the equipment from any electrical or pneumatic power supply before handling the valve.

Cleaning the Valve

Caution



Prior to performing any removal and cleaning of the 653 valve, please refer to, and strictly follow, all applicable company safety procedures. If allowed by your company safety procedures, the valve may be cleaned *after* removal from the system. Any cleaning material used *must* be compatible with 316 sst plus nickel, the selected elastomer, as well as any process material/by-products which may be deposited on the valve.

The process wetted parts - shaft, flapper, and valve body - are 316L stainless steel. They may be cleaned using appropriate chemicals to remove process contamination. The other parts should be cleaned in non-reactive solvents. Do not dip the motor or switches in cleaning fluid. Inspect all parts for damage - nicks, dents, wear, distortion and corrosion. If any parts appear to be damaged, contact MKS for repair or replacement. Polish wetted surfaces to remove stains, paying particular attention to O-ring sealing surfaces.

Appendix A: Product Specifications

General Specifications

CE Compliance Electromagnetic Compatibility ² Machinery	EMC Directive 89/336/EEC Machinery Directive 89/392/EEC
Compatible Controllers	MKS Type 651, 1651, 652 (Revision B or later)
Speed (open to close)	1.7 seconds
Resolution	1/12,000
Valve body operating temperature Standard: Optional:	0° to 100° C 0° to 150° C ³
Valve motor ambient operating temperature	-20° to +40° C
Differential pressure across valve	1 atm. (15 psig) maximum
External leakage at shaft seal Materials exposed to process	1 x 10 ⁻⁷ scc/sec He for 1 min. with 1 ATM Δ P 316L sst, Viton [®]
Shaft/Flapper seal ⁴	Viton

Due to continuing research and development activities, these product specifications are subject to change without notice.

² An overall metal braided shielded cable, properly grounded at both ends, is required during use.

³Consistent with shaft seal and flapper seal O-ring material.

⁴Where Viton is used, other materials are available; consult factory for additional information.

This page intentionally left blank.

Appendix B: ASA Series Flange Specifications

This page intentionally left blank.

Appendix C: ISO-NW Series Flange Specifications

This page intentionally left blank.

Appendix D: CF Series Flange Specifications

This page intentionally left blank.

Appendix E: JIS Series Flange Specifications

This page intentionally left blank.

Index

A

ASA Series flanges, 10, 25

C

Cables, 15

CE compliance, 15, 23

CF Series flanges, 11, 29

Connector, 17

Construction, material, 5

Controller, 5, 19, 23

Customer support, 6

D

Diffusion pump, 20

Dimensions, 9

F

Flanges, 5, 9–14, 25–31

I

Interface cables, 15

Interface connector, 17

Introduction, 5

ISO-NW Series flanges, 12, 27

J

JIS Series flanges, 14, 31

K

KF Series flanges, 14

M

Maintenance, 22

Manual, organization, 6

O

Operating temperature, 8

Operation, general, 20

P

Pressure controller, 5, 9, 19, 23

R

Requirements, environmental, 8

Returning the product, 6, 7, 21

S

Safety information, 1

Safety precautions, 21

Setup, 8

Symbols, 2

T

Temperature

 maximum, 5

 operating, 8

V

Valve body, temperature, 5

Valve, cleaning, 22