

**MKS Baratron® Type
622C/626C
Absolute Pressure Transducers
and
623B
Absolute Pressure Transducer with
Trippoint Relays**

Copyright © 2013 by MKS Instruments, Inc.

All rights reserved. No part of this work may be reproduced or transmitted in any form or by any means, electronic or mechanical, including photocopying and recording, or by any information storage or retrieval system, except as may be expressly permitted in writing by MKS Instruments, Inc.

Printed in the United States of America

Swagelok[®], VCR[®], and VCO[®] are registered trademarks of Swagelok Co., Solon, OH, USA.

mksinst[™] is a trademark and Baratron[®] is a registered trademark of MKS Instruments, Inc., Andover, MA, USA.

Inconel[®] and Incoloy[®] are registered trademarks of Inco Alloys International, Huntington, WV, USA.

Some Baratron[®] products may not be exported to many end user countries without both US and local government export licenses under ECCN 2B230.

Table of Contents

Pressure Transducer Safety Information.....	1
Symbols Used in This Instruction Manual.....	1
Symbols Found on the Unit	2
Safety Procedures and Precautions	3
Sicherheitshinweise für den Druckmeßumformer	5
In dieser Betriebsanleitung vorkommende Symbole	5
Erklärung der am Gerät angebrachten Symbole	6
Sicherheitsvorschriften und Vorsichtsmaßnahmen.....	7
Informations relatives à la sécurité pour le transducteur de pression	9
Symboles utilisés dans ce manuel d'utilisation	9
Symboles apparaissant sur l'unité	10
Mesures de sécurité et précautions	11
Medidas de seguridad del transductor de presión	13
Símbolos usados en este manual de instrucciones	13
Símbolos hallados en la unidad.....	14
Procedimientos y precauciones de seguridad.....	15
Chapter One: General Information	17
Introduction.....	17
How This Manual is Organized	18
Customer Support	18
Chapter Two: Installation	19
How To Unpack.....	19
Unpacking Checklist.....	19
Interface Cables	20
Generic Shielded Cable Guidelines	21
Product Location and Requirements.....	23
Fittings	24
Setup	25
Checking the Transducer Zero.....	25

Coarse Zero Adjustment	26
Dimensions	28
Electrical Information	30
Connectors	31
Chapter Three: Overview	35
General	35
Sensor	35
Signal Conditioner/Electronics	35
Chapter Four: Operation	36
General	36
Lowest Suggested Pressure Available for Reading	36
Lowest Suggested Pressure to Use for Control	36
Type 623B End Cap	37
Hysteresis of Type 623B Trip Relays	37
How To Set the Trip Points on Type 623B	40
How To Adjust the Trip Point Direction	41
How To Adjust the Trip Point Hysteresis on Type 623B	45
Chapter Five: Maintenance and Troubleshooting	47
General	47
Zero Adjustment	47
Troubleshooting Chart	48
Appendix A: Product Specifications	49
MKS Types 622C and 626C Units	49
Type 623B Transducer	50
Appendix B: Model Code Explanation	51
Model Code	51
Index	53

List of Figures and Tables

Figures

Figure 1: Preferred Method To Connect an Overall Metal Braided Shielded Cable	22
Figure 2: Alternate Method To Connect an Overall Metal Braided Shielded Cable	22
Figure 3: Metal Single and Double Ferrule Compression-type Vacuum Fittings	24
Figure 4: Location of the Zero Pot on Transducer Endcaps	26
Figure 5: Location of the COARSE ZERO Adjustment Control.....	27
Figure 6: Dimensions of the Types 622B, 623B, and 626C Transducers.....	29
Figure 7: Power, Signal, and Chassis Grounding Scheme.....	30
Figure 8: Type 623B Endcap.....	37
Figure 9: How Hysteresis Affects Accuracy and Relay Chatter.....	39
Figure 10: How To Measure the Trip Point Voltage for Type 623B.....	40
Figure 11: The Relay Board.....	42
Figure 12: The Alternate Relay Board.....	43

Tables

Table 1: Definition of Symbols Found on the Unit	2
Tabelle 2: Bedeutung der am Gerät angebrachten Symbole.....	6
Tableau 3: Définition des symboles apparaissant sur l'unité	10
Tabla 4: Definición de los símbolos hallados en la unidad.....	14
Table 5: Interface Cables	20
Table 6: Highest Pressure Suggested for Proper Zero Adjustment.....	26
Table 7: Required Inputs for Types 622B, 623B, and 626C Transducers	30
Table 8: Post Assignments of Type 622C Transducer.....	31
Table 9: Pinout of Type 626C Transducer.....	32
Table 10: Post Assignments of Type 623B Transducer, TB1.....	33
Table 11: Post Assignments of Type 623B Transducer, TB2.....	33
Table 12: Suggested Pressures for Reading and Control.....	36
Table 13: Factory-Set Positions of the Shorting Jumpers.....	44
Table 14: Shorting Jumper Positions for Hysteresis.....	45

Table 15: Troubleshooting Chart 48

Pressure Transducer Safety Information

Symbols Used in This Instruction Manual

Definitions of WARNING, CAUTION, and NOTE messages used throughout the manual.

Warning

The **WARNING** sign denotes a hazard to personnel. It calls attention to a procedure, practice, condition, or the like, which, if not correctly performed or adhered to, could result in injury to personnel.

Caution

The **CAUTION** sign denotes a hazard to equipment. It calls attention to an operating procedure, practice, or the like, which, if not correctly performed or adhered to, could result in damage to or destruction of all or part of the product.

Note

The **NOTE** sign denotes important information. It calls attention to a procedure, practice, condition, or the like, which is essential to highlight.

Symbols Found on the Unit

The following table describes symbols that may be found on the unit.























Definition of Symbols Found on the Unit			
  Off (Supply) IEC 417, No.5008	 Off (Supply) IEC 417, No.5008	  Protective earth (ground) IEC 417, No.5019	 Protective earth (ground) IEC 417, No.5019
    Alternating current IEC 417, No.5032	  Alternating current IEC 417, No.5032	  Alternating current IEC 417, No.5032	 Alternating current IEC 417, No.5032
 Both direct and alternating current IEC 417, No.5033-a	  Three phase alternating current IEC 617-2 No.020206	 Three phase alternating current IEC 617-2 No.020206	
 Caution, refer to accompanying documents ISO 3864, No.B.3.1	 Caution, risk of electric shock ISO 3864, No.B.3.6	 Caution, hot surface IEC 417, No.5041	

Table 1: Definition of Symbols Found on the Unit

Safety Procedures and Precautions

Observe the following general safety precautions during all phases of operation of this instrument. Failure to comply with these precautions or with specific warnings elsewhere in this manual violates safety standards of intended use of the instrument and may impair the protection provided by the equipment. MKS Instruments, Inc. assumes no liability for the customer's failure to comply with these requirements.

DO NOT SUBSTITUTE PARTS OR MODIFY INSTRUMENT

Do not install substitute parts or perform any unauthorized modification to the instrument. Return the instrument to an MKS Calibration and Service Center for service and repair to ensure that all safety features are maintained.

SERVICE BY QUALIFIED PERSONNEL ONLY

Operating personnel must not attempt component replacement and internal adjustments. Any service must be made by qualified service personnel only.

USE CAUTION WHEN OPERATING WITH HAZARDOUS MATERIALS

If hazardous materials are used, users must take responsibility to observe the proper safety precautions, completely purge the instrument when necessary, and ensure that the material used is compatible with the materials in this product, including any sealing materials.

PURGE THE INSTRUMENT

After installing the unit, or before removing it from a system, purge the unit completely with a clean, dry gas to eliminate all traces of the previously used flow material.

USE PROPER PROCEDURES WHEN PURGING

This instrument must be purged under a ventilation hood, and gloves must be worn for protection.

DO NOT OPERATE IN AN EXPLOSIVE ENVIRONMENT

To avoid explosion, do not operate this product in an explosive environment unless it has been specifically certified for such operation.

USE PROPER FITTINGS AND TIGHTENING PROCEDURES

All instrument fittings must be consistent with instrument specifications, and compatible with the intended use of the instrument. Assemble and tighten fittings according to manufacturer's directions.

CHECK FOR LEAK-TIGHT FITTINGS

Carefully check all vacuum component connections to ensure leak-tight installation.

OPERATE AT SAFE INLET PRESSURES

Never operate at pressures higher than the rated maximum pressure (refer to the product specifications for the maximum allowable pressure).

INSTALL A SUITABLE BURST DISC

When operating from a pressurized gas source, install a suitable burst disc in the vacuum system to prevent system explosion should the system pressure rise.

KEEP THE UNIT FREE OF CONTAMINANTS

Do not allow contaminants to enter the unit before or during use. Contamination such as dust, dirt, lint, glass chips, and metal chips may permanently damage the unit or contaminate the process.

ALLOW PROPER WARM UP TIME FOR TEMPERATURE-CONTROLLED UNITS

Temperature-controlled units will only meet specifications when sufficient time is allowed for the unit to meet, and stabilize at, the designed operating temperature. Do not zero or calibrate the unit until the warm up is complete.

Sicherheitshinweise für den Druckmeßumformer

In dieser Betriebsanleitung vorkommende Symbole

Bedeutung der mit WARNUNG!, VORSICHT! und HINWEIS gekennzeichneten Absätze in dieser Betriebsanleitung.

Warnung!



Das Symbol **WARNUNG!** weist auf eine Gefahr für das Bedienpersonal hin. Es macht auf einen Arbeitsablauf, eine Arbeitsweise, einen Zustand oder eine sonstige Gegebenheit aufmerksam, deren unsachgemäße Ausführung bzw. ungenügende Berücksichtigung zu Verletzungen führen kann.

Vorsicht!



Das Symbol **VORSICHT!** weist auf eine Gefahr für das Gerät hin. Es macht auf einen Bedienungsablauf, eine Arbeitsweise oder eine sonstige Gegebenheit aufmerksam, deren unsachgemäße Ausführung bzw. ungenügende Berücksichtigung zu einer Beschädigung oder Zerstörung des Gerätes oder von Teilen des Gerätes führen kann.

Hinweis



Das Symbol **HINWEIS** macht auf wichtige Informationen bezüglich eines Arbeitsablaufs, einer Arbeitsweise, eines Zustands oder einer sonstige Gegebenheit aufmerksam.

Erklärung der am Gerät angebrachten Symbole

Nachstehender Tabelle sind die Bedeutungen der Symbole zu entnehmen, die am Gerät angebracht sein können.















Bedeutung der am Gerät angebrachten Symbole			
			
Ein (Energie) IEC 417, No.5007	Aus (Energie) IEC 417, No.5008	Erdanschluß IEC 417, No.5017	Schutzleiteranschluß IEC 417, No.5019
			
Masseanschluß IEC 417, No.5020	Aquipotential- anschluß IEC 417, No.5021	Gleichstrom IEC 417, No.5031	Wechselstrom IEC 417, No.5032
			
Gleich- oder Wechselstrom IEC 417, No.5033-a	Durchgängige doppelte oder verstärkte Isolierung IEC 417, No.5172-a	Dreileiter- Wechselstrom (Drehstrom) IEC 617-2, No.020206	
			
Warnung vor einer Gefahrenstelle (Achtung, Dokumen- tation beachten) ISO 3864, No.B.3.1	Warnung vor gefährlicher elektrischer Spannung ISO 3864, No.B.3.6	Höhere Temperatur an leicht zugänglichen Teilen IEC 417, No.5041	

Tabelle 2: Bedeutung der am Gerät angebrachten Symbole

Sicherheitsvorschriften und Vorsichtsmaßnahmen

Folgende allgemeine Sicherheitsvorschriften sind während allen Betriebsphasen dieses Gerätes zu befolgen. Eine Mißachtung der Sicherheitsvorschriften und sonstiger Warnhinweise in dieser Betriebsanleitung verletzt die für dieses Gerät und seine Bedienung geltenden Sicherheitsstandards, und kann die Schutzvorrichtungen an diesem Gerät wirkungslos machen. MKS Instruments, Inc. haftet nicht für Mißachtung dieser Sicherheitsvorschriften seitens des Kunden.

Niemals Teile austauschen oder Änderungen am Gerät vornehmen!

Ersetzen Sie keine Teile mit baugleichen oder ähnlichen Teilen, und nehmen Sie keine eigenmächtigen Änderungen am Gerät vor. Schicken Sie das Gerät zwecks Wartung und Reparatur an den MKS-Kalibrierungs- und -Kundendienst ein. Nur so wird sichergestellt, daß alle Schutzvorrichtungen voll funktionsfähig bleiben.

Wartung nur durch qualifizierte Fachleute!

Das Auswechseln von Komponenten und das Vornehmen von internen Einstellungen darf nur von qualifizierten Fachleuten durchgeführt werden, niemals vom Bedienpersonal.

Vorsicht beim Arbeiten mit gefährlichen Stoffen!

Wenn gefährliche Stoffe verwendet werden, muß der Bediener die entsprechenden Sicherheitsvorschriften genauestens einhalten, das Gerät, falls erforderlich, vollständig spülen, sowie sicherstellen, daß der Gefahrstoff die am Gerät verwendeten Materialien, insbesondere Dichtungen, nicht angreift.

Spülen des Gerätes mit Gas!

Nach dem Installieren oder vor dem Ausbau aus einem System muß das Gerät unter Einsatz eines reinen Trockengases vollständig gespült werden, um alle Rückstände des Vorgängermediums zu entfernen.

Anweisungen zum Spülen des Gerätes

Das Gerät darf nur unter einer Ablufthaube gespült werden. Schutzhandschuhe sind zu tragen.

Gerät nicht zusammen mit explosiven Stoffen, Gasen oder Dämpfen benutzen!

Um der Gefahr einer Explosion vorzubeugen, darf dieses Gerät niemals zusammen mit (oder in der Nähe von) explosiven Stoffen aller Art eingesetzt werden, sofern es nicht ausdrücklich für diesen Zweck zugelassen ist.

Anweisungen zum Installieren der Armaturen!

Alle Anschlußstücke und Armaturenteile müssen mit der Gerätespezifikation übereinstimmen, und mit dem geplanten Einsatz des Gerätes kompatibel sein. Der Einbau, insbesondere das Anziehen und Abdichten, muß gemäß den Anweisungen des Herstellers vorgenommen werden.

Verbindungen auf Undichtigkeiten prüfen!

Überprüfen Sie sorgfältig alle Verbindungen der Vakuumkomponenten auf undichte Stellen.

Gerät nur unter zulässigen Anschlußdrücken betreiben!

Betreiben Sie das Gerät niemals unter Drücken, die den maximal zulässigen Druck (siehe Produktspezifikationen) übersteigen.

Geeignete Berstscheibe installieren!

Wenn mit einer unter Druck stehenden Gasquelle gearbeitet wird, sollte eine geeignete Berstscheibe in das Vakuumsystem installiert werden, um eine Explosionsgefahr aufgrund von steigendem Systemdruck zu vermeiden.

Verunreinigungen im Gerät vermeiden!

Stellen Sie sicher, daß Verunreinigungen jeglicher Art weder vor dem Einsatz noch während des Betriebs in das Instrumenteninnere gelangen können. Staub- und Schmutzpartikel, Glassplitter oder Metallspäne können das Gerät dauerhaft beschädigen oder Prozeß und Meßwerte verfälschen.

Bei Geräten mit Temperaturkontrolle korrekte Anwärmzeit einhalten!

Temperaturkontrollierte Geräte arbeiten nur dann gemäß ihrer Spezifikation, wenn genügend Zeit zum Erreichen und Stabilisieren der Betriebstemperatur eingeräumt wird. Kalibrierungen und Nulleinstellungen sollten daher nur nach Abschluß des Anwärmvorgangs durchgeführt werden.

Informations relatives à la sécurité pour le transducteur de pression

Symboles utilisés dans ce manuel d'utilisation

Définitions des indications AVERTISSEMENT, ATTENTION, et REMARQUE utilisées dans ce manuel.

Avertissement



L'indication **AVERTISSEMENT** signale un danger pour le personnel. Elle attire l'attention sur une procédure, une pratique, une condition, ou toute autre situation présentant un risque d'accident pour le personnel, en cas d'exécution incorrecte ou de non respect des consignes.

Attention



L'indication **ATTENTION** signale un danger pour l'appareil. Elle attire l'attention sur une procédure d'exploitation, une pratique, ou toute autre situation, présentant un risque d'endommagement ou de destruction d'une partie ou de la totalité de l'appareil, en cas d'exécution incorrecte ou de non respect des consignes.

Remarque



L'indication **REMARQUE** signale une information importante. Elle attire l'attention sur une procédure, une pratique, une condition, ou toute autre situation, présentant un intérêt particulier.

Symboles apparaissant sur l'unité

Le tableau suivant décrit les symboles pouvant apparaître sur l'unité.















Définition des symboles apparaissant sur l'unité			
			
Marche (sous tension) IEC 417, No.5007	Arrêt (hors tension) IEC 417, No.5008	Terre (masse) IEC 417, No.5017	Terre de protection (masse) IEC 417, No.5019
			
Masse IEC 417, No.5020	Equipotentialité IEC 417, No.5021	Courant continu IEC 417, No.5031	Courant alternatif IEC 417, No.5032
			
Courant continu et alternatif IEC 417, No.5033-a	Matériel de classe II IEC 417, No.5172-a	Courant alternatif triphase IEC 617-2, No.020206	
			
Attention : se reporter à la documentation ISO 3864, No.B.3.1	Attention : risque de choc électrique ISO 3864, No.B.3.6	Attention : surface brûlante IEC 417, No.5041	

Tableau 3: Définition des symboles apparaissant sur l'unité

Mesures de sécurité et précautions

Prendre les précautions générales de sécurité suivantes pendant toutes les phases d'exploitation de cet appareil. Le non respect des ces précautions ou des avertissements contenus dans ce manuel constitue une violation des normes de sécurité relatives à l'utilisation de l'appareil et peut diminuer la protection fournie par l'appareil. MKS Instruments, Inc. n'assume aucune responsabilité concernant le non respect des consignes par les clients.

PAS DE SUBSTITUTION DE PIÈCES OU DE MODIFICATION DE L'APPAREIL

Ne pas installer des pièces de substitution ou effectuer des modifications non autorisées sur l'appareil. Renvoyer l'appareil à un centre de service et de calibrage MKS pour tout dépannage ou réparation afin de garantir le l'intégrité des dispositifs de sécurité.

DÉPANNAGE UNIQUEMENT PAR DU PERSONNEL QUALIFIÉ

Le personnel d'exploitation ne doit pas essayer de remplacer des composants ou de faire des réglages internes. Tout dépannage doit être uniquement effectué par du personnel qualifié.

PRÉCAUTION EN CAS D'UTILISATION AVEC DES PRODUITS DANGEREUX

Si des produits dangereux sont utilisés, l'utilisateur est responsable de la prise des mesures de précaution appropriées, de la purge complète de l'appareil quand cela est nécessaire, et de la garantie que les produits utilisés sont compatibles avec les composants de cet appareil, y compris les matériaux d'étanchéité.

PURGE DE L'APPAREIL

Après l'installation de l'unité, ou avant son enlèvement d'un système, purger l'unité complètement avec un gaz propre et sec afin d'éliminer toute trace du produit de flux utilisé précédemment.

UTILISATION DES PROCÉDURES APPROPRIÉES POUR LA PURGE

Cet appareil doit être purgé sous une hotte de ventilation, et il faut porter des gants de protection.

PAS D'EXPLOITATION DANS UN ENVIRONNEMENT EXPLOSIF

Pour éviter toute explosion, ne pas utiliser cet appareil dans un environnement explosif, sauf en cas d'homologation spécifique pour une telle exploitation.

UTILISATION D'ÉQUIPEMENTS APPROPRIÉS ET PROCÉDURES DE SERRAGE

Tous les équipements de l'appareil doivent être cohérents avec ses spécifications, et compatibles avec l'utilisation prévue de l'appareil. Assembler et serrer les équipements conformément aux directives du fabricant.

VÉRIFICATION DE L'ÉTANCHÉITÉ DES CONNEXIONS

Vérifier attentivement toutes les connexions des composants pour le vide afin de garantir l'étanchéité de l'installation.

EXPLOITATION AVEC DES PRESSIONS D'ENTRÉE NON DANGEREUSES

Ne jamais utiliser des pressions supérieures à la pression nominale maximum (se reporter aux spécifications de l'unité pour la pression maximum admissible).

INSTALLATION D'UN DISQUE D'ÉCHAPPEMENT ADAPTÉ

En cas d'exploitation avec une source de gaz pressurisé, installer un disque d'échappement adapté dans le système à vide, afin d'éviter une explosion du système en cas d'augmentation de la pression.

MAINTIEN DE L'UNITÉ À L'ABRI DES CONTAMINATIONS

Ne pas laisser des produits contaminants pénétrer dans l'unité avant ou pendant l'utilisation. Des produits contaminants tels que des poussières et des fragments de tissu, de glace et de métal peuvent endommager l'unité d'une manière permanente ou contaminer le processus.

RESPECT DU TEMPS D'ÉCHAUFFEMENT APPROPRIÉ POUR LES UNITÉS À TEMPÉRATURE CONTRÔLÉE

Les unités à température contrôlée atteignent leurs spécifications uniquement quand on leur laisse un temps suffisant pour atteindre d'une manière stable la température d'exploitation. Ne pas remettre à zéro ou calibrer l'unité tant que l'échauffement n'est pas terminé.

Medidas de seguridad del transductor de presión

Símbolos usados en este manual de instrucciones

Definiciones de los mensajes de advertencia, precaución y de las notas usados en el manual.

Advertencia



El símbolo de advertencia indica la posibilidad de que se produzcan daños personales. Pone de relieve un procedimiento, práctica, estado, etc. que en caso de no realizarse u observarse correctamente puede causar daños personales.

Precaución



El símbolo de precaución indica la posibilidad de producir daños al equipo. Pone de relieve un procedimiento operativo, práctica, estado, etc. que en caso de no realizarse u observarse correctamente puede causar daños o la destrucción total o parcial del equipo.

Nota



El símbolo de notas indica información de importancia. Este símbolo pone de relieve un procedimiento, práctica o condición cuyo conocimiento es esencial destacar.

Símbolos hallados en la unidad

La tabla siguiente contiene los símbolos que puede hallar en la unidad.















Definición de los símbolos hallados en la unidad			
			
Encendido (alimentación eléctrica) IEC 417, N° 5007	Apagado (alimentación eléctrica) IEC 417, N° 5008	Puesta a tierra IEC 417, N° 5017	Protección a tierra IEC 417, N° 5019
			
Caja o chasis IEC 417, N° 5020	Equipotencialidad IEC 417, N° 5021	Corriente continua IEC 417, N° 5031	Corriente alterna IEC 417, N° 5032
			
Corriente continua y alterna IEC 417, N° 5033-a	Equipo de clase II IEC 417, N° 5172-a	Corriente alterna trifásica IEC 617-2, N° 020206	
			
Precaución. Consulte los documentos adjuntos ISO 3864, N° B.3.1	Precaución. Riesgo de descarga eléctrica ISO 3864, N° B.3.6	Precaución. Superficie caliente IEC 417, N° 5041	

Tabla 4: Definición de los símbolos hallados en la unidad

Procedimientos y precauciones de seguridad

Las precauciones generales de seguridad descritas a continuación deben observarse durante todas las etapas de funcionamiento del instrumento. La falta de cumplimiento de dichas precauciones o de las advertencias específicas a las que se hace referencia en el manual, constituye una violación de las normas de seguridad establecidas para el uso previsto del instrumento y podría anular la protección proporcionada por el equipo. Si el cliente no cumple dichas precauciones y advertencias, MKS Instruments, Inc. no asume responsabilidad legal alguna.

NO UTILICE PIEZAS NO ORIGINALES O MODIFIQUE EL INSTRUMENTO

No instale piezas que no sean originales ni modifique el instrumento sin autorización. Para asegurar el correcto funcionamiento de todos los dispositivos de seguridad, envíe el instrumento al Centro de servicio y calibración de MKS toda vez que sea necesario repararlo o efectuar tareas de mantenimiento.

LAS REPARACIONES DEBEN SER EFECTUADAS ÚNICAMENTE POR TÉCNICOS AUTORIZADOS

Los operarios no deben intentar reemplazar los componentes o realizar tareas de ajuste en el interior del instrumento. Las tareas de mantenimiento o reparación deben ser realizadas únicamente por personal autorizado.

TENGA CUIDADO CUANDO TRABAJE CON MATERIALES TÓXICOS

Cuando se utilicen materiales tóxicos, es responsabilidad de los operarios tomar las medidas de seguridad correspondientes, purgar totalmente el instrumento cuando sea necesario y comprobar que el material utilizado sea compatible con los materiales del instrumento e inclusive, con todos los materiales de sellado.

PURGUE EL INSTRUMENTO

Una vez instalada la unidad o antes de retirarla del sistema, purgue completamente la unidad con gas limpio y seco para eliminar todo resto de la sustancia líquida empleada anteriormente.

USE PROCEDIMIENTOS ADECUADOS PARA REALIZAR LA PURGA

El instrumento debe purgarse debajo de una campana de ventilación y deben utilizarse guantes protectores.

NO HAGA FUNCIONAR EL INSTRUMENTO EN AMBIENTES CON RIESGO DE EXPLOSIÓN

Para evitar que se produzcan explosiones, no haga funcionar este instrumento en un ambiente con riesgo de explosiones, excepto cuando el mismo haya sido certificado específicamente para tal uso.

USE ACCESORIOS ADECUADOS Y REALICE CORRECTAMENTE LOS PROCEDIMIENTOS DE AJUSTE

Todos los accesorios del instrumento deben cumplir las especificaciones del mismo y ser compatibles con el uso que se debe dar al instrumento. Arme y ajuste los accesorios de acuerdo con las instrucciones del fabricante.

COMPRUEBE QUE LAS CONEXIONES SEAN A PRUEBA DE FUGAS

Inspeccione cuidadosamente las conexiones de los componentes de vacío para comprobar que hayan sido instalados a prueba de fugas.

HAGA FUNCIONAR EL INSTRUMENTO CON PRESIONES DE ENTRADA SEGURAS

No haga funcionar nunca el instrumento con presiones superiores a la máxima presión nominal (en las especificaciones del instrumento hallará la presión máxima permitida).

INSTALE UNA CÁPSULA DE SEGURIDAD ADECUADA

Cuando el instrumento funcione con una fuente de gas presurizado, instale una cápsula de seguridad adecuada en el sistema de vacío para evitar que se produzcan explosiones cuando suba la presión del sistema.

MANTENGA LA UNIDAD LIBRE DE CONTAMINANTES

No permita el ingreso de contaminantes en la unidad antes o durante su uso. Los productos contaminantes tales como polvo, suciedad, pelusa, lascas de vidrio o virutas de metal pueden dañar irreparablemente la unidad o contaminar el proceso.

CALIENTE ADECUADAMENTE LAS UNIDADES CONTROLADAS POR MEDIO DE TEMPERATURA

Las unidades controladas por medio de temperatura funcionarán de acuerdo con las especificaciones sólo cuando se las caliente durante el tiempo suficiente para permitir que lleguen y se estabilicen a la temperatura de operación indicada. No calibre la unidad y no la ponga en cero hasta que finalice el procedimiento de calentamiento.

Chapter One: General Information

Introduction

Note

Some Baratron[®] products may not be exported to many end user countries without both US and local government export licenses under ECCN 2B230.

The MKS Baratron[®] Types 622B, and 626C Absolute Pressure Transducers are part of the MKS family of general purpose pressure transducers designed to provide accurate, reliable, and repeatable pressure measurements in the range from 1000 Torr to as low as 0.10 Torr F.S. (626C only). These instruments are RoHS (Restriction of Hazardous Substances)-compliant, operate with ± 15 VDC ($\pm 5\%$) input voltage @ 35 mA or 75 mA, and provide a 0 - 10 VDC analog output linear with pressure. All of these products expose only Inconel[®] and Incoloy[®] to the process, permitting use with corrosive or dirty gases and eliminating contamination of the process with transducer materials. Measurements are independent of gas composition and all of the units have a minimum measuring range of four decades.

Using the latest single-sided, dual-electrode Inconel transducer design, coupled with a low impedance, fixed-frequency bridge signal conditioner, these instruments are capable of withstanding high overpressure conditions (45 psia) with minimal or no shifts in output over their range. The advanced bridge signal conditioning technology provides high accuracy and operation which is extremely temperature-stable at operating pressure.

Protection from RF interference and noisy electrical environments is increased by the use of a metal case, by internal design elements, and by the use of surge and ESD suppression networks and RFI filtering on all inputs and outputs.

The Types 622C and 626C transducers have an accuracy of 0.25% of reading, with the exception of the 626C in its 0.10 and 0.25 Torr ranges, which has an accuracy of 0.50% of reading. Type 626C products with ranges of 10 to 1000 Torr may also be ordered with an optional accuracy of 0.15% of reading. The 622C and 626C models are identical except for their electrical connectors; the 622C unit has a 5-post terminal block connector, and the 626C unit has a 15-pin D-subminiature connector. These instruments have been developed for applications requiring a small, economical transducer, which delivers accurate and repeatable measurements with a resolution of 1×10^{-4} F.S.

The Type 623B instrument adds two (2) trip relays that can be individually adjusted to activate or de-activate between 0.1 and 100% of the Baratron's full-scale measurement range. It is available in ranges from 10 to 1000 Torr, and has two (2) terminal blocks for connection to the host system.

How This Manual is Organized

This manual is designed to provide information and instructions in the proper installation, operation, and maintenance of the MKS Types 622B, 623B, and 626C Absolute Pressure Transducers. Product specifications are provided at the end of the manual.

Before installing your absolute pressure transducer in a system and/or operating it, carefully read and familiarize yourself with all precautionary notes in the *Safety Messages and Procedures* section at the front of this manual. In addition, observe and obey all WARNING and CAUTION notes provided throughout the manual.

Chapter One, *General Information*, (this chapter) introduces the product and describes the organization of the manual.

Chapter Two, *Installation*, explains the environmental requirements and describes how to mount the instrument in your system.

Chapter Three, *Overview*, gives a brief description of the instrument and its functionality.

Chapter Four, *Operation*, describes how to use the instrument and explains all the functions and features.

Chapter Five, *Maintenance and Troubleshooting*, provides maintenance and troubleshooting information.

Appendix A, *Product Specifications*, lists the specifications of the instrument.

Appendix B, *Model Code Explanation*, describes the model code used to order the instrument.

Customer Support

Standard maintenance and repair services are available at all of our regional MKS Calibration and Service Centers, listed on the back cover. In addition, MKS accepts the instruments of other manufacturers for recalibration using the Primary and Transfer Standard calibration equipment located at all of our regional service centers. Should any difficulties arise in the use of your Type 622B, 623B, or 626C instrument, or to obtain information about companion products MKS offers, contact any authorized MKS Calibration and Service Center. If it is necessary to return the instrument to MKS, please obtain an RMA (Return Materials Authorization) Number from the MKS Calibration and Service Center before shipping. The RMA Number expedites handling and ensures proper servicing of your instrument.

Please refer to the inside of the back cover of this manual for a list of MKS Calibration and Service Centers.

Warning



All returns to MKS Instruments must be free of harmful, corrosive, radioactive, or toxic materials.

Chapter Two: Installation

How To Unpack

MKS has carefully packed the Type 622C/623C/626C unit so that it will reach you in perfect operating order. Upon receiving the unit, however, you should check for defects, cracks, broken connectors, etc., to be certain that damage has not occurred during shipment.

Note

Do *not* discard any packing materials until you have completed your inspection and are sure the unit arrived safely.

If you find any damage, notify your carrier and MKS immediately. If it is necessary to return the unit to MKS, obtain an RMA (Return Material Authorization) Number from the MKS Service Center before shipping. Please refer to the inside of the back cover of this manual for a list of MKS Calibration and Service Centers.

Unpacking Checklist

Standard Equipment:

- The Type 622B, 623B, or 626C Absolute Pressure Transducer (specified at time of order).
- The Types 622C and 623B transducers come with a mating connector for the transducer's terminal block connector(s).

Optional Equipment:

The Types 622B, 623B, and 626C transducers are compatible with:

- Most MKS Pressure, Flow, Flow Ratio, and Throttling Valve Controllers
- Most MKS Power Supply/Readouts
- Optional RM-6 rack mount kit permits mounting one or two Readouts and/or Controllers in a 19" rack
- Appropriate cables (Refer to *Interface Cables*, page 20, for information.)
- Electrical Connector Accessories Kit, 626B-K1

Interface Cables

As of July 20, 2009, most products shipped to the European Community must comply with the EMC Directive 2004/108/EC, which covers radio frequency emissions and immunity tests. In addition, as of July 20, 2009, some products shipped to the European Community must also comply with the Product Safety Directive 92/59/EC and Low Voltage Directive 73/23/EC, which cover general safety practices for design and workmanship. MKS products that meet these requirements are identified by application of the CE Mark.

To ensure compliance with EMC Directive 2004/108/EC, an overall metal braided shielded cable, properly grounded at both ends, is required during use. No additional installation requirements are necessary to ensure compliance with Directives 92/59/EC and 73/23/EC.

Note



An overall metal braided, shielded cable, properly grounded at both ends, is required during use to meet CE specifications.

PRODUCT	146, 660, PR4000	PDR2000	PDR-C-1C/2C
622C	CB112S-2-10	n/a	CB473S-1-10
623B	CB112S-2-10	n/a	CB473S-1-10
626C	CB259S-5-10	CB2000S-1-M1	CB127S-1-10

Table 5: Interface Cables

For cables connecting to non-MKS products, MKS can provide normal shielding or braided shielded cable assemblies in a nominal 10' (3m) length, terminating in *flying leads* (pigtail) fashion at both ends. Braided shielded cable assemblies are recommended if the environment contains high EMI/RFI noise.

The connector pinouts are listed on the transducer endcaps and in Table 8 and Table 9, page 31, and Table 10, page 33.

Generic Shielded Cable Guidelines

Should you choose to manufacture your own cables, follow the guidelines listed below:

1. The cable must have an overall metal *braided* shield, covering all wires. Neither aluminum foil nor spiral shielding will be as effective; using either may nullify regulatory compliance.
2. The connectors must have a metal case which has direct contact to the cable's shield on the whole circumference of the cable. The inductance of a flying lead or wire from the shield to the connector will seriously degrade the shield's effectiveness. The shield should be grounded to the connector before its internal wires exit.
3. With very few exceptions, the connector(s) must make good contact to the device's case (ground). "Good contact" is about 0.01 ohms; and the ground should surround all wires. Contact to ground at just one point may not suffice.
4. For shielded cables with flying leads at one or both ends; it is important at each such end, to ground the shield *before* the wires exit. Make this ground with absolute minimum length. Refer to Figures 1 and 2, page 22. (A ¼ inch piece of #22 wire may be undesirably long since it has approximately 5 nH of inductance, equivalent to 31 ohms at 1000 MHz). After picking up the braid's ground, keep wires and braid flat against the case. With very few exceptions, grounded metal covers are not required over terminal strips. If one is required, it will be stated in the Declaration of Conformity or in the instruction manual.
5. In selecting the appropriate type and wire size for cables, consider:
 - A. The voltage ratings.
 - B. The cumulative I^2R heating of all the conductors (keep them safely cool).
 - C. The IR drop of the conductors, so that adequate power or signal voltage gets to the device.
 - D. The capacitance and inductance of cables which are handling fast signals, (such as data lines or stepper motor drive cables).
 - E. That some cables may need internal shielding from specific wires to others; please see the instruction manual for details regarding this matter.

Example 1: Preferred Method To Connect Cable
(shown on a transducer)

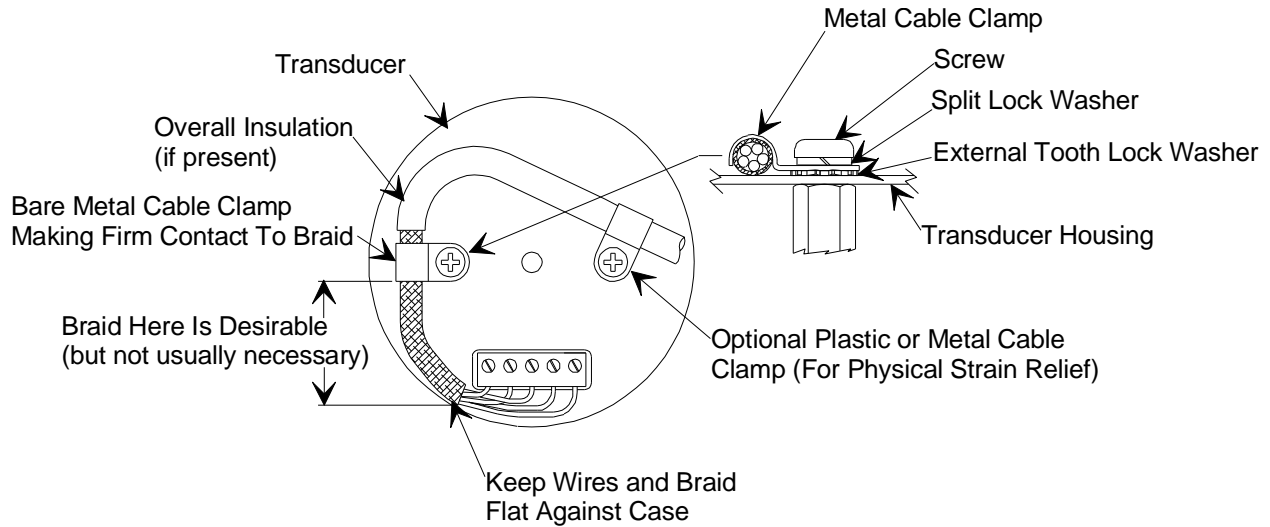

Figure 1: Preferred Method To Connect an Overall Metal Braided Shielded Cable

Example 2: Alternate Method To Connect Cable
(shown on a transducer)

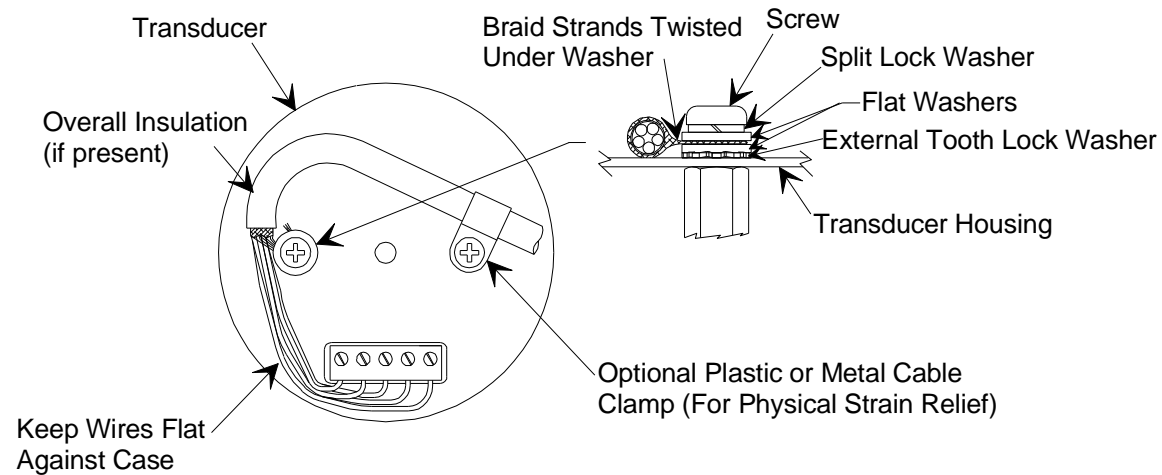

Figure 2: Alternate Method To Connect an Overall Metal Braided Shielded Cable
Use this method when cable clamp is not available

Product Location and Requirements

Types 622C and 626B:

- Ambient operating temperature should remain between 0° C and 50° C (32° F and 122° F).
- For 626C with 0.25 or 0.10 Torr ranges, the ambient operating temperature should remain between 15°C and 40°C (59°F and 104°F).
- Input required is ± 15 VDC ($\pm 5\%$) @ 35 mA (maximum) with < 20 mV p-p noise and ripple

Type 623B

- Ambient operating temperature should remain between 0° C and 50° C (32° F and 122° F).
- Input required is ± 15 VDC ($\pm 5\%$) @ 75 mA (maximum) with < 20 mV p-p noise and ripple

Note



The maximum temperature specification is provided for general guidance under ideal conditions. If the switch is located in an enclosed environment or where air flow is limited or impeded in any way please consult your local MKS office for additional guidance.

For additional product requirements refer to *Appendix A: Product Specifications*, page 49.

Fittings

The transducer port will easily carry the weight of the transducer. The following is a list of available fittings:

- ½” diameter (12.7 mm) tubulation
- NW16-KF
- Swagelok® 8-VCR® (female)
- Swagelok 8-VCO® (female)
- 1.33 inch (33.8 mm) O.D. CF

Caution



MKS does not warranty the 622B, 623B, or 626C transducers when single or double metal ferrule compression-type vacuum fittings (shown in Figure 3, page 24) are used because damage will occur to the transducer when improper tightening procedures are followed.

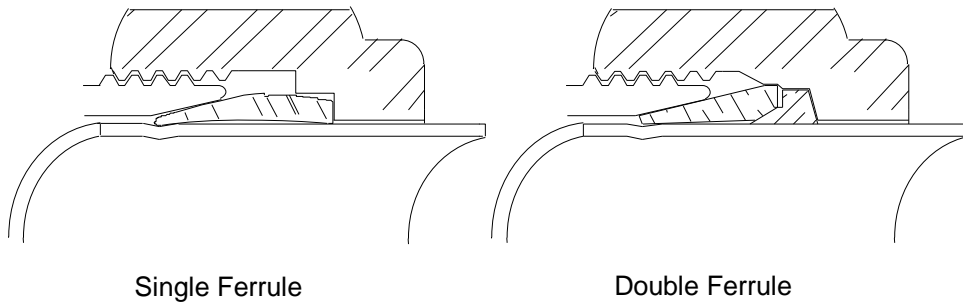

Figure 3: Metal Single and Double Ferrule Compression-type Vacuum Fittings

Setup

Mount the transducer with the inlet port pointing (vertically) downward. Although the unit can be mounted in any orientation, mounting it as suggested allows any foreign matter entering the pressure port to fall away from the diaphragm.

Isolate the unit from vibration as much as possible. When not subject to gas damping at low pressure, the diaphragm may become susceptible to resonance. The 0.1, 0.25, and 1 Torr F.S. units are most sensitive and you should isolate these units from any vibration that exists. Remember to isolate the vibration through the cable as well as through the port.

Checking the Transducer Zero

Check the transducer zero prior to the initial operation and then periodically as required. The zero can be set (or reset) by adjusting the zero potentiometer located on the top cover of the transducer or at the front panel of any MKS Power Supply/Readout which is being used. The unit must be *fully stabilized* before you change the zero adjustment. Stabilization is accomplished by allowing the unit to warm up for approximately 15 minutes.

Pump the unit, with the power on, down to a pressure less than the transducer's resolution (0.01% of Full Scale).

Note

Once the unit is properly warmed up and stabilized, the zero adjustment must be made at a pressure less than the transducer's resolution (0.01% of F.S.). Low range transducers (< 1 Torr F.S.) should be pumped for at least one hour after exposure to air to remove any moisture and to allow the pressure to stabilize.

Zeroing a transducer above its stated minimum resolution creates a *zero offset* relative (or unique) to the system in which the transducer is located. All subsequent readings are then linear and accurate *relative to the offset value*.

Refer to Figure 4, page 26, for the location of the zero potentiometers.

Note

If available pressures are not sufficiently low to set the transducer zero, you may use a vacuum leak detector with sufficient vacuum pumping (to achieve proper zeroing pressures). In this case, mount the transducer on the leak detector *in the same plane of orientation as it will be during actual use*.

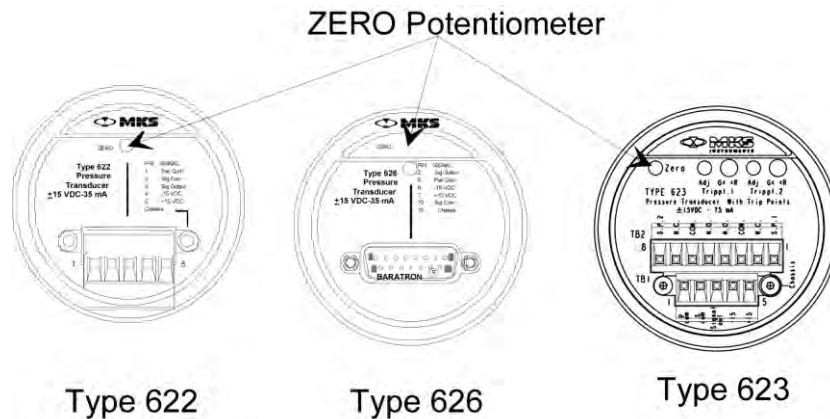

Figure 4: Location of the Zero Pot on Transducer Endcaps

To properly zero a transducer, follow this procedure:

1. Install the transducer a system with a power supply/readout.
2. Power the transducer and allow it to warm up. Warm up time is 15 minutes.
3. Pump the unit down to a pressure below its resolution (refer to Table 6 for recommended pressure levels).
4. Using a small screwdriver, adjust the ZERO pot until the readout displays zero (0000).

Highest Pressure Suggested for Proper Zero Adjustment	
Full Scale Range (Torr)	Highest Pressure for Zero Adjustment (Torr)
0.1*	$< 5 \times 10^{-6}$
0.25*	$< 5 \times 10^{-6}$
1	$< 5 \times 10^{-5}$
2	$< 1 \times 10^{-4}$
10	$< 5 \times 10^{-4}$
100	$< 5 \times 10^{-3}$
1000	$< 5 \times 10^{-2}$
<i>* Only available with Type 626C transducer</i>	

Table 6: Highest Pressure Suggested for Proper Zero Adjustment

Coarse Zero Adjustment

Some ranges of the 600 Series transducers provide additional zero range capability through the coarse zero adjustment feature. Please contact MKS applications for specific ranges and help on making this adjustment. The zero potentiometer provides ample control under normal conditions.

Note

Use the coarse zero adjustment only if the zero potentiometer fails to provide sufficient adjustment.

The COARSE ZERO control is accessible through the side of the instrument, as shown in Figure 5.

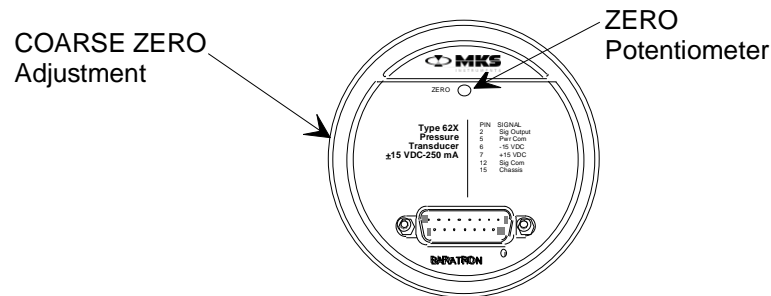

Figure 5: Location of the COARSE ZERO Adjustment Control

Follow the steps below to adjust the coarse zero:

1. Install the transducer in a system with a power supply/readout.
2. Turn the transducer on.
3. Be sure the transducer has been operating for at least 15 minutes and is pumped down below its resolution (refer to Table 6, page 26, for recommended pressure levels).
4. Center the ZERO pot located at the top of the transducer (adjust the screw to leave an equal amount of adjustment both clockwise and counterclockwise).
5. Remove the top plastic outer ring by rotating 45° CCW for 626C 0.10 Torr only.
6. Turn the COARSE ZERO's multi-position switch (located on the side of the unit) to a position that produces the output signal closest to zero Volts.
7. Re-install the plastic ring.
8. Adjust the ZERO pot (located on the top of the unit) to bring the output to exactly zero Volts.

Dimensions

Note

All dimensions are listed in inches with millimeters referenced in parentheses.

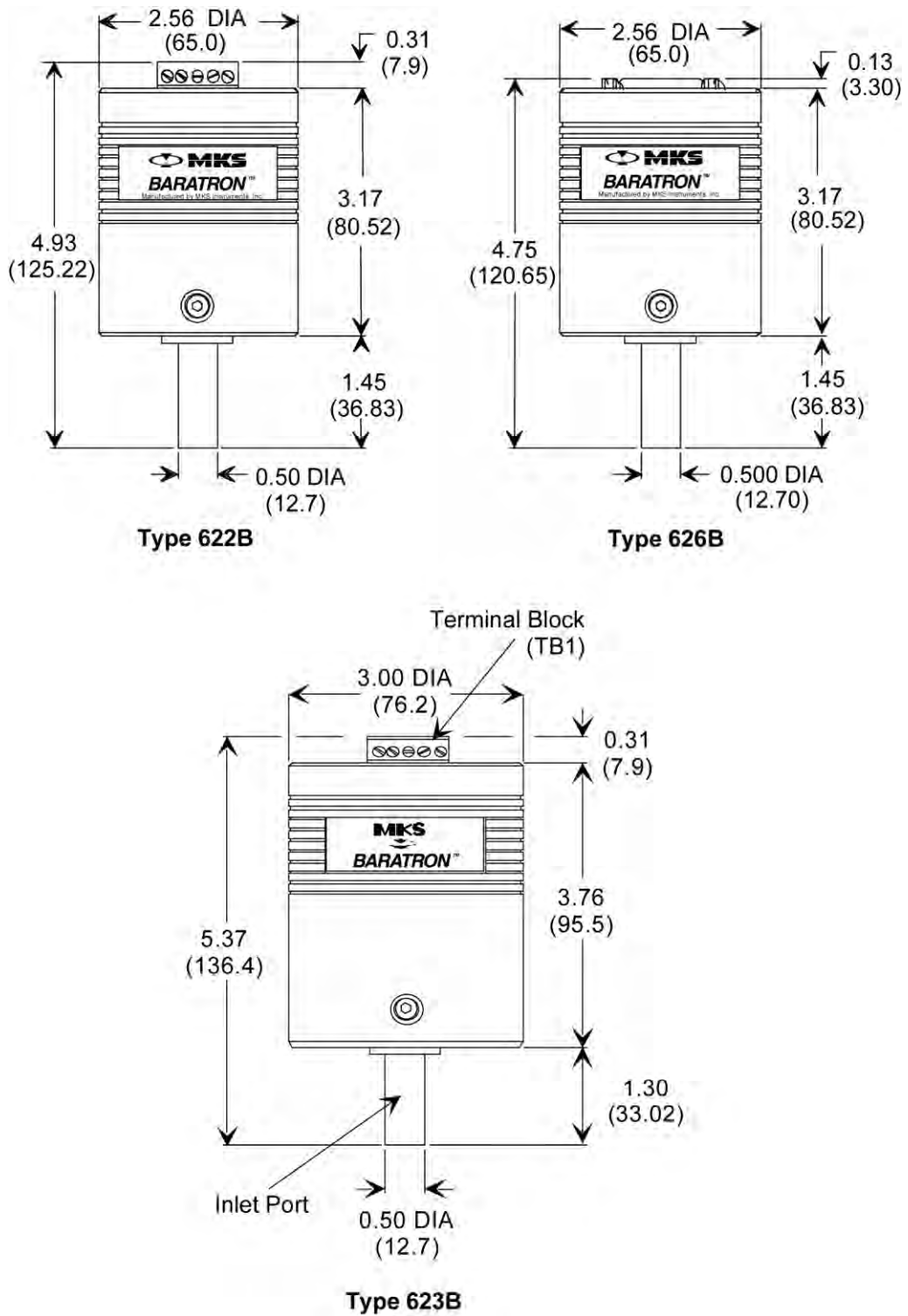

Figure 6: Dimensions of the Types 622B, 623B, and 626C Transducers

Electrical Information

The Types 622B, 623B, and 626C transducers require an external power source capable of supplying the voltages stated in Table 7. Noise and ripple should be less than 20 mV p-p. You may use any readout device which has input capabilities of less than 0 to greater than 10 VDC, and impedance greater than 10K ohms.

Note



The ground of any external power supply and readout should be the same as the transducer ground (chassis ground) to minimize any possible ground loops which can affect the performance and stability of the system.

Input Required	Types 622C & 626B	Type 623B
At Startup	±15 VDC (±5%) @ 35 mA	±15 VDC (±5%) @ 75 mA
After 1 hour of operation at 25° C	±15 VDC (±5%) @ 35 mA	±15 VDC (±5%) @ 75 mA

Table 7: Required Inputs for Types 622B, 623B, and 626C Transducers

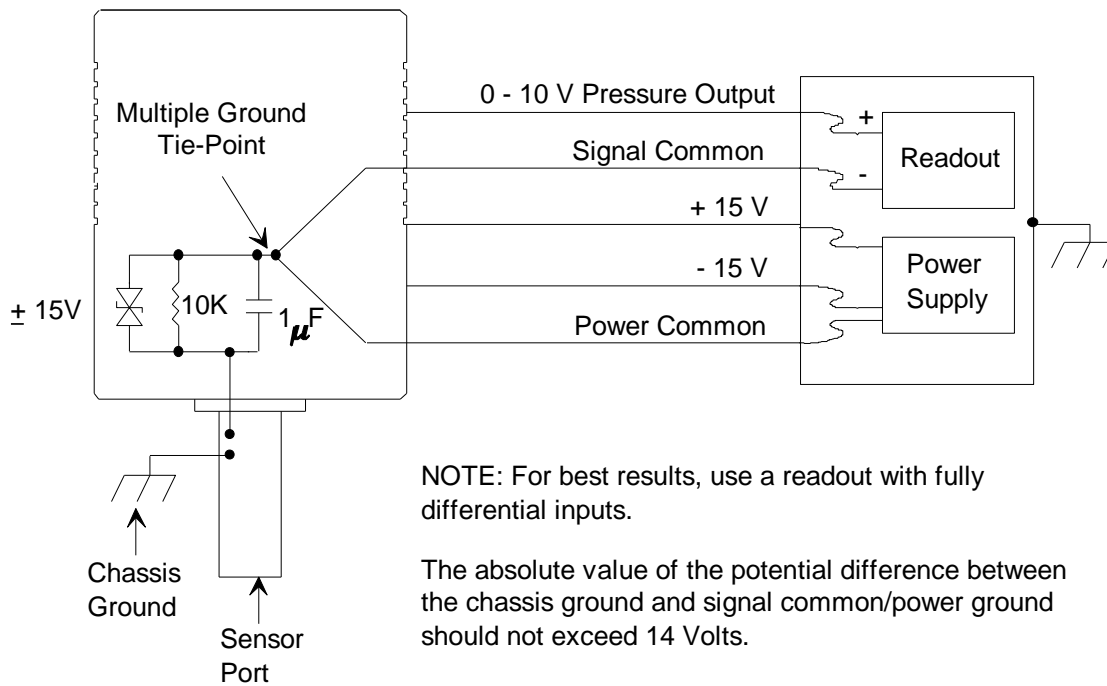

Figure 7: Power, Signal, and Chassis Grounding Scheme

Connectors

The 622C unit has a 5-pin terminal block connector, whose post assignments are listed in Table 8. The 626C uses a 15-pin Type “D” connector; its pinouts are shown in Table 9. The 623B transducer uses two (2) terminal blocks: a 5-post block known as TB1, and an 8-post block designated as TB2. The post assignments for both of these blocks are shown in Tables 10 and 11.

Post Assignments of Type 622C Transducer	
Post Number	Assignment
1	Power Common
2	Signal Common
3	Signal Output
4	- 15 VDC
5	+ 15 VDC
<i>Chassis Ground is made by using the screw labeled CHASSIS on the endcap</i>	

Table 8: Post Assignments of Type 622C Transducer

Pinout of Type 626C Transducer	
Pin Number	Assignment
1	No connection
2	Signal Output
3	No connection
4	No connection
5	Power Common
6	- 15 VDC
7	+ 15 VDC
8	No connection
9	No connection
10	No connection
11	No connection
12	Signal Common
13	No connection
14	No connection
15	Chassis Ground

Table 9: Pinout of Type 626C Transducer

Terminal Block 1 (TB1) Pinout (Type 623B only)	
Pin Number	Signal
1	Power Common
2	Signal Common
3	Signal Output
4	- 15 VDC
5	+ 15 VDC
<i>Chassis Ground is made by using the screw labeled CHASSIS</i>	

Table 10: Post Assignments of Type 623B Transducer, TB1

Terminal Block 2 (TB2) Pinout (Type 623B only)	
Pin Number	Signal
1	Trip Point A Level (0 to 10 Volts)*
2	Trip Point A Relay, Normally Closed
3	Trip Point A Relay, Common
4	Trip Point A Relay, Normally Open
5	Trip Point B Relay, Normally Open
6	Trip Point B Relay, Common
7	Trip Point B Relay, Normally Closed
8	Trip Point B Level (0 to 10 Volts)*
<i>* Use pin 2 of TB1 for trip point signal common</i>	

Table 11: Post Assignments of Type 623B Transducer, TB2

Chapter Three: Overview

General

A complete pressure transducer system requires three components to convert pressure to a linear DC voltage output: a sensor, signal conditioner, and power supply. An analog or digital meter is required to display the DC output in pressure units.

MKS Types 622B, 623B, and 626C transducers contain two of the above components: the sensor and signal conditioner. An MKS or MKS-compatible power supply is required to complete the pressure to DC voltage output conversion, and an MKS or MKS-compatible display unit is required for direct pressure readout.

Sensor

The variable capacitance sensor consists of a pressure inlet tube (port) connected to a small chamber in the transducer body. One wall of this chamber is an elastic metal diaphragm. The front side of the diaphragm is exposed to the gas whose pressure is to be measured. The back, or *reference*, side of the diaphragm faces a rigidly mounted ceramic disc containing two electrodes. The reference side is permanently evacuated (10^{-7} Torr) and its vacuum is maintained with a chemical getter system.

The diaphragm deflects with changing absolute pressure (force per unit area) independently of the gas type or composition of the measured gas. This deflection causes an imbalance of the sensor electrode capacitances since the distance to the diaphragm is now different for each electrode. The imbalance of capacitances is converted to a DC voltage in the bridge. This bridge is excited by a precision constant frequency oscillator. The resultant signal is then linearized, zeroed, and amplified via the signal conditioner electronics, to produce a precise 0 to 10 VDC signal scaled to the range of the transducer.

Signal Conditioner/Electronics

The signal conditioner contains state-of-the-art, low impedance balanced bridge circuitry, self-compensated for thermal stability with ambient temperature changes. Output is a DC voltage which is linear with pressure. The transducer is then calibrated against a pressure standard to provide a 0 to 10 Volt DC output over the range of the transducer.

Chapter Four: Operation

General

After installation and during periodic maintenance, check the transducer zero to verify proper output. If the output is incorrect, set the output by adjusting the zero potentiometer (refer to *Checking the Transducer Zero*, page 25, for zeroing instructions).

The transducer should be powered and allowed to warm up before use. Warm up time is 15 minutes.

Lowest Suggested Pressure Available for Reading

The pressures listed in the middle column of Table **Error! Bookmark not defined.2**, page 36, reflect reliable and practical pressures for different range transducers. Lower readings may be obtained in environments which have stable temperature and air flow.

As noted in Table **Error! Bookmark not defined.2**, page 36, unheated transducers can obtain these measurements down to 1×10^{-4} Torr.

Lowest Suggested Pressure to Use for Control

The pressures listed in the last column of Table **Error! Bookmark not defined.2**, page 36, are for reference, and represent the pressure reading of the transducer at 50 mV signal output. A DC signal of at least 50 mV is the recommended minimum signal level to use when integrating any transducer into complex processing systems.

Suggested Pressures for Reading and Control		
Full Scale Range (Torr)	Lowest Suggested Pressure for Reading (Torr)	Lowest Suggested Pressure for Control (Torr)
0.1 (Type 626C only)	5×10^{-5}	5×10^{-4}
0.25 (Type 626C only)	1×10^{-4}	1×10^{-3}
1 (Types 622C and 626B)	5×10^{-4}	5×10^{-3}
2 (Types 622C and 626B)	1×10^{-3}	1×10^{-2}
10	5×10^{-3}	5×10^{-2}
20	1×10^{-3}	1×10^{-1}
100	5×10^{-2}	5×10^{-1}
500	2.5×10^{-1}	2.5
1000	5×10^{-1}	5

Table 12: Suggested Pressures for Reading and Control

Type 623B End Cap

Figure 8 shows the endcap of a Type 623B instrument.

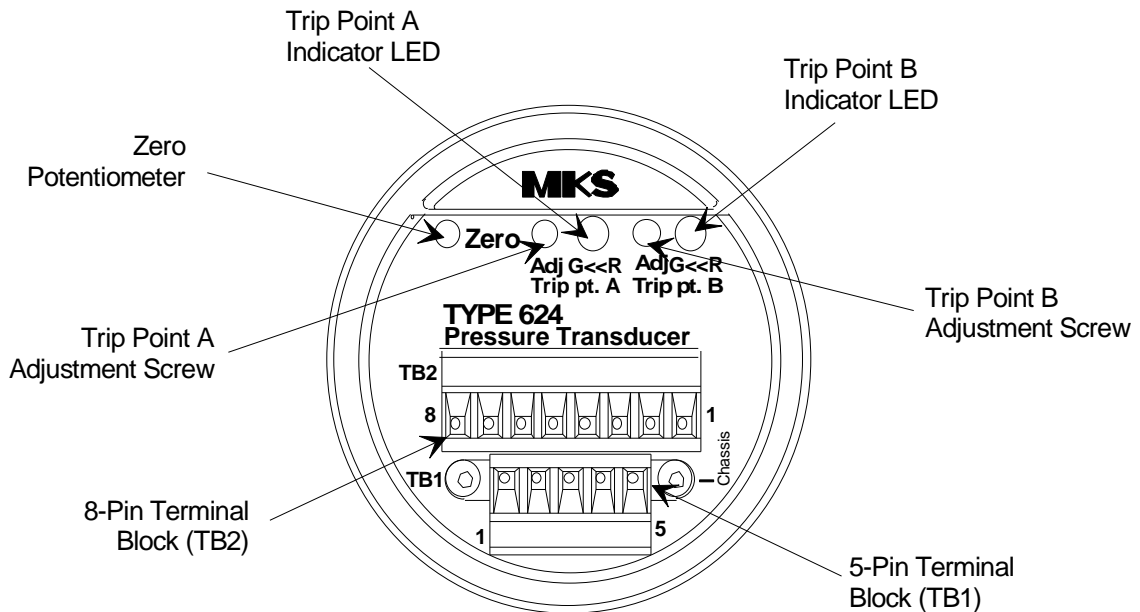

Figure 8: Type 623B Endcap

The endcap provides easy access for zero adjustment, electrical connections to terminal blocks TB1 and TB2, and trip point adjustment screws. The LEDs illuminate to indicate when the transducer is powered, and to indicate the status of the pressure relative to each of the trip points. A green LED indicates the pressure is *below* the alarm trip point, and a red LED indicates the pressure is *above* the alarm trip point.

Hysteresis of Type 623B Trip Relays

Hysteresis is built into the operation of the two trip points to help compensate for the noise inherent in all systems. Without hysteresis, the noise may cause the relays to repeatedly switch states, a condition known as “relay chatter.” Each trip point has a separate hysteresis setting.

Setting the hysteresis too high creates a *deadband* around the trip point. The deadband prevents the trip point relay from responding to changes in the pressure signal around the trip point. Ideally, the hysteresis should be close to, but not less than, the peak-to-peak noise to provide maximum immunity from relay chatter while providing the best possible accuracy. It may take some trial and error efforts to determine the best hysteresis setting for your system.

Figure 9, page 39, shows a system in which the relay is energized when the pressure falls *below* the trip point setting.

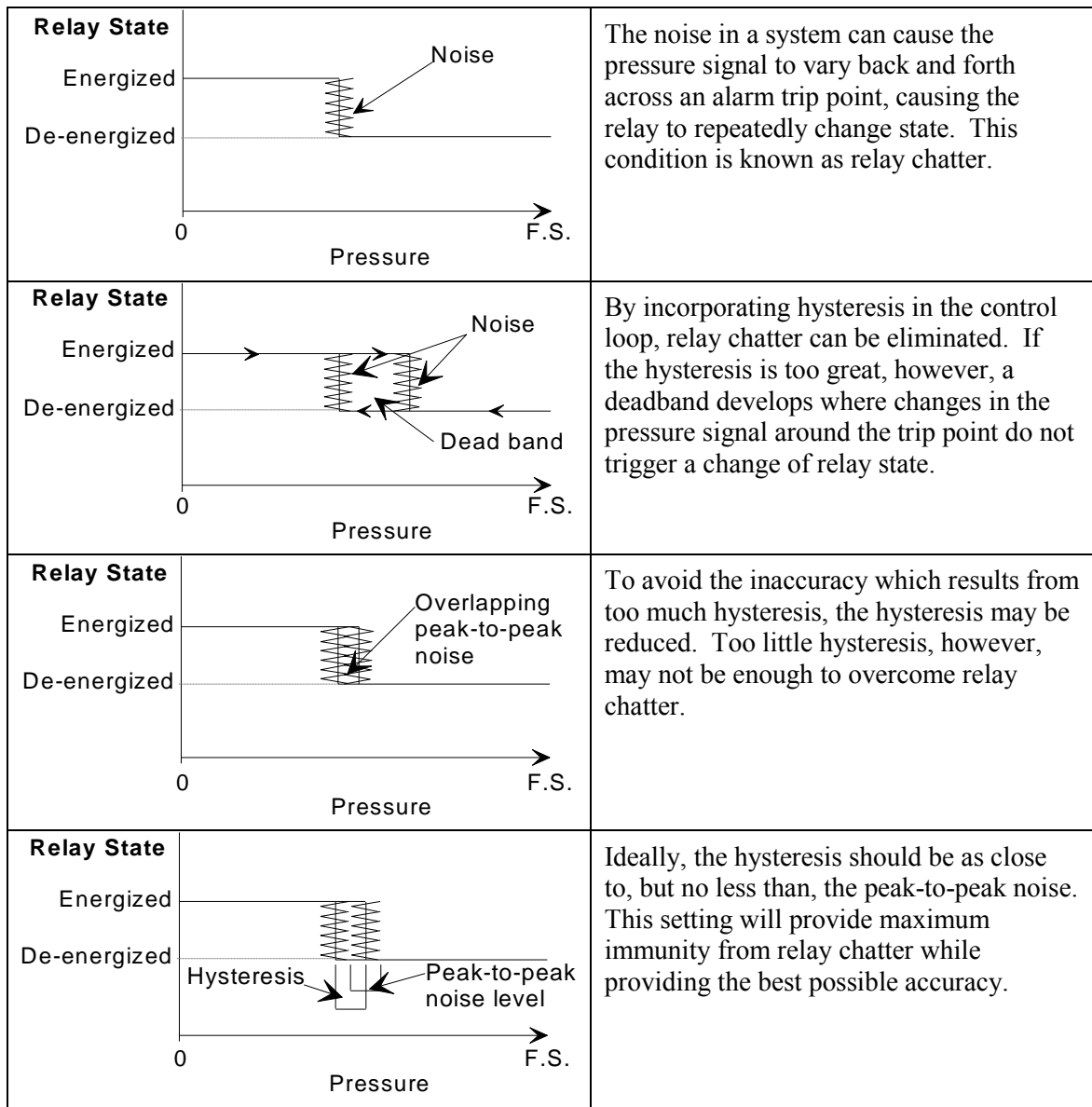

Figure 9: How Hysteresis Affects Accuracy and Relay Chatter

How To Set the Trip Points on Type 623B

There are two trip points, labeled as Trip Point A and Trip Point B, on the 623B transducer, each with its own trip point adjustment. The voltage for Trip Point A can be measured with a voltmeter across pins 1 (on TB2) and pin 2 (on TB1). The voltage for Trip Point B can be measured across pin 8 (on TB2) and pin 2 (on TB1).

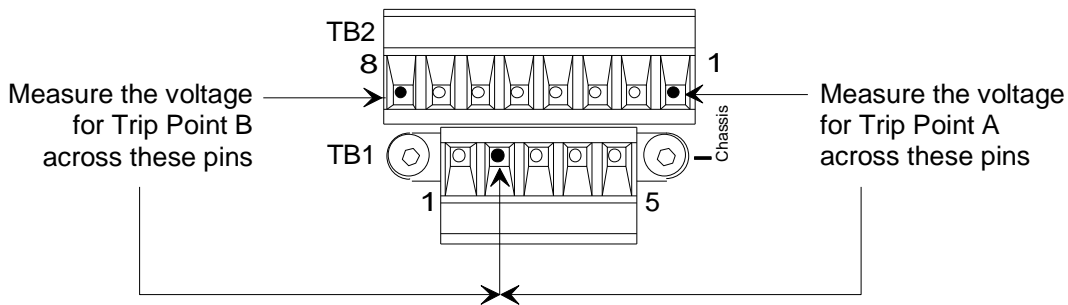

Figure 10: How To Measure the Trip Point Voltage for Type 623B

To adjust a trip point, turn the appropriate trip point adjustment screw (refer to Figure 8, page 37) until the voltage displayed on the voltmeter equals the voltage of the pressure output signal at the desired trip point level.

For example, if at the desired trip point pressure the output signal is 8 Volts, turn the appropriate trip point adjustment screw until the voltmeter reads 8 Volts. If you want an output signal of 8 Volts at the trip point, turn the appropriate trip point adjustment screw until the voltmeter reads 8 Volts.

Note



Due to hysteresis, the actual relay trip point pressure may be slightly higher than the pressure for which the trip point was set. The difference between the *set* trip point pressure and the *actual* trip point pressure will vary depending upon the degree of hysteresis you have selected.

Note



The electromechanical trip point relays in this product are fit for general purpose applications. If the manometer is intended for use in high cycle count applications including, but not limited to, Atomic Layer Deposition, please consult your local office for advice on more appropriate available MKS solutions.

Refer to *Hysteresis*, page 37, and *How To Adjust the Trip Point Hysteresis*, page 45, for more information.

How To Adjust the Trip Point Direction

The trip point direction defines the direction of pressure change that will energize the trip point. The trip point direction for the Type 623B transducer is initially set “low”; the trip points are energized as the pressure falls *below* the specified trip point level. The trip point direction can be changed to “high”; so that the trip points energize as the pressure rises *above* their respective trip points.

To change the trip point direction:

1. Turn off power to the transducer and disconnect the cables from TB1 and TB2.
2. Push down on the colored ring on the endcap, turn it about $\frac{1}{4}$ turn counterclockwise, and lift it off the endcap.
3. Remove the two screws on each side of TB1.
4. Lift off the graphics panel.

The Relay Board with jumpers J12, J13, J15, and J16 is now accessible. The Relay Board will be one of the two types shown in Figure 11, page 42, and Figure 12, page 43. You can easily identify whether your unit contains the Relay Board or alternate Relay Board by the location of the jumpers as shown in the figures.

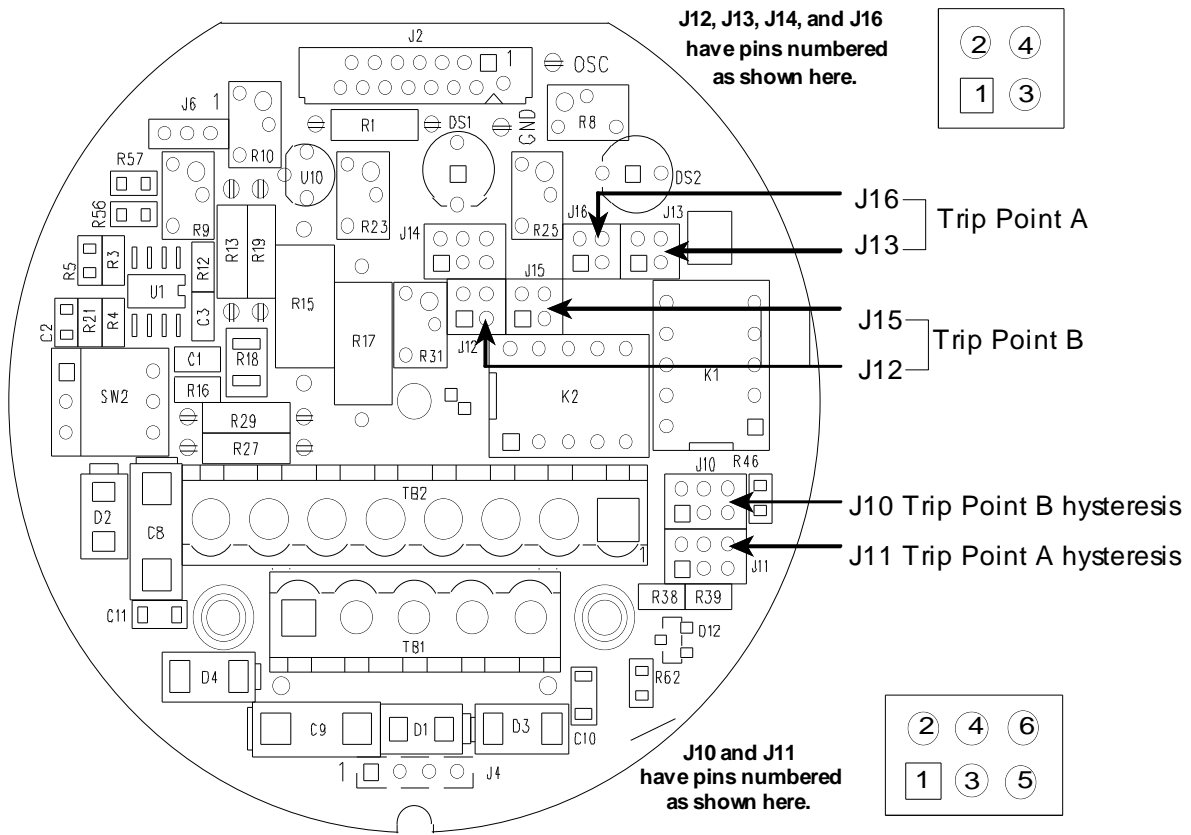

Figure 11: The Relay Board

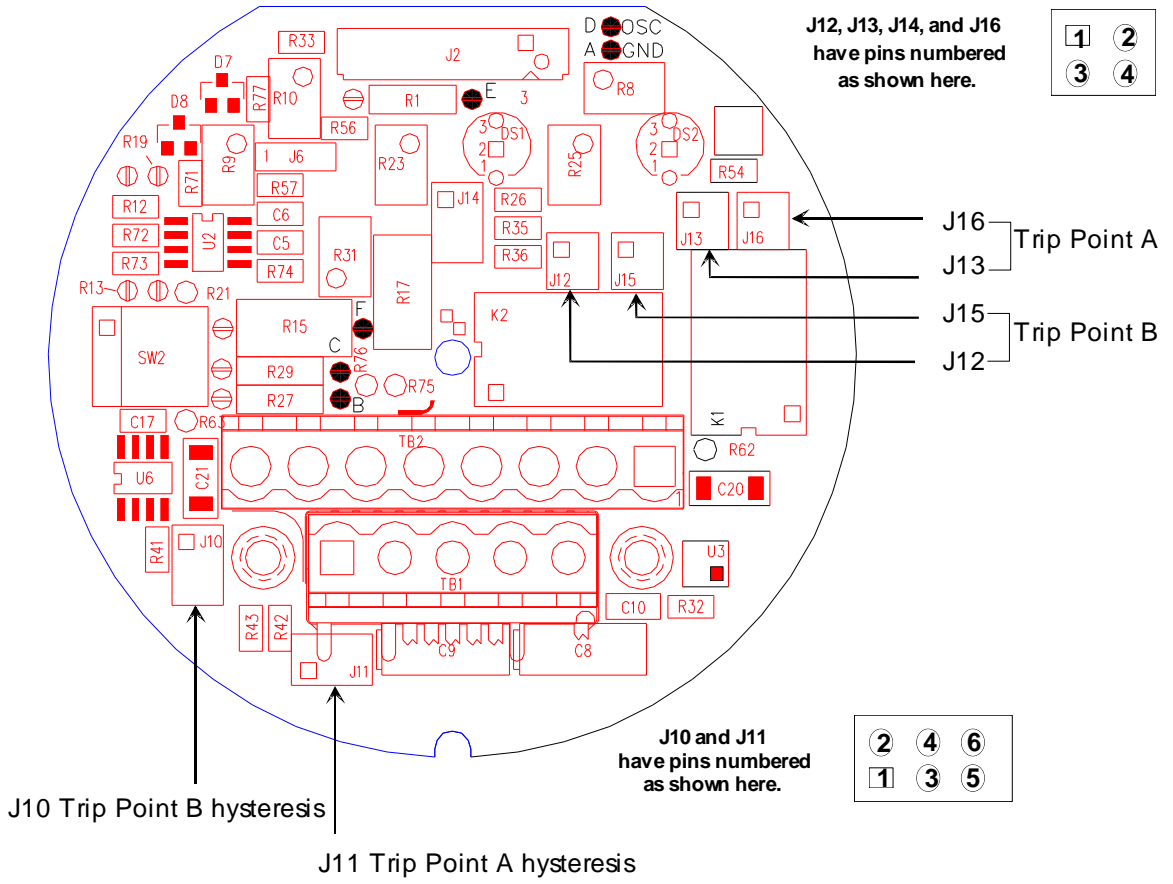

Figure 12: The Alternate Relay Board

5. Move the shorting jumpers on jumpers J13 and J16 to change the configuration of Trip Point A, and move the shorting jumpers on jumpers J12 and J15 to change the configuration of Trip Point B.

Refer to Figure 11, page 42, and Figure 12, page 43, for the location of the jumpers, and to Table 13, shown below, for the factory-set positions of the shorting jumpers.

Factory-Set Positions of the Shorting Jumpers		
Trip Point	Energized <i>Below</i> Trip Point	Energized <i>Above</i> Trip Point
Trip Point A	J13: 1-3, 2-4 J16: 1-3, 2-4	J13: 1-2, 3-4 J16: 1-2, 3-4
Trip Point B	J12: 1-3, 2-4 J15: 1-3, 2-4	J12: 1-2, 3-4 J15: 1-2, 3-4

Table 13: Factory-Set Positions of the Shorting Jumpers

6. Replace the graphics panel.
7. Replace the two screws on each side of TB1.
8. Replace the ring on the endcap and push down while turning it about $\frac{1}{4}$ turn clockwise.
9. Reconnect the trip point cable to TB2.
10. Reconnect the power supply/readout cable to TB1.
11. Turn power back on to the transducer.

Note



The trip points are automatically de-energized when the unit is without power. To use either the open or closed contacts on the relay, make the appropriate connections to terminal block TB2.

How To Adjust the Trip Point Hysteresis on Type 623B

Hysteresis is built into the operation of the two alarm relays on the Type 623B to help compensate for the noise inherent in all systems. Without hysteresis, the noise may cause the alarm relays to chatter (repeatedly switch states). On the Relay board in the types 623B unit are jumpers J11 (for Trip Point A) and J10 (for Trip Point B). You can adjust the amount of hysteresis separately for each alarm relay by placing shorting jumpers on J11 and J10.

Refer to *Hysteresis*, page 37, for an explanation of the effect of different amounts of hysteresis.

To change the transducer's configuration:

1. Turn off power to the unit and disconnect the cables from TB1 and TB2.
2. Push down on the colored ring on the endcap, turn it about ¼ turn counterclockwise, and lift it off the endcap.
3. Remove the two screws on each side of TB1.
4. Lift off the graphics panel.

The relay board with jumpers J10, J11, J12, J13, J15, and J16 is now accessible.

Refer to Figure 10, page 42, and Figure **Error! Bookmark not defined.**1, page 43, for the location of jumpers J10 and J11.

5. Move the shorting jumpers on jumper J11 to change the hysteresis of Trip Point A and move the shorting jumpers on jumper J10 to change the hysteresis of Trip Point B.

Refer to Table 14 for the correct position of the shorting jumpers.

Shorting Jumper Positions for Hysteresis		
Hysteresis (% of FS)	Trip Point A	Trip Point B
0.1%	J11: 2 - 4	J10: 2 - 4
0.2%	J11: 4 - 6	J10: 4 - 6
0.5%	J11: 1 - 3	J10: 1 - 3
<i>Factory-set position</i>		
1%	J11: 3 - 5	J10: 3 - 5
2%	J11: 3 - 4	J10: 3 - 4

Table 14: Shorting Jumper Positions for Hysteresis

6. Replace the graphics panel.
7. Replace the two screws on each side of TB1.
8. Replace the ring on the endcap and push down while turning it about $\frac{1}{4}$ turn clockwise.
9. Reconnect the trip point cable to TB2.
10. Reconnect the power supply/readout cable to TB1.
11. Turn power back on to the transducer.

Chapter Five: Maintenance and Troubleshooting

General

In general, no maintenance is required other than proper installation and operation, and an occasional zero adjustment. If a transducer fails to operate properly upon receipt, check for shipping damage, and check the power/signal cable for correct continuity. Any damage should be reported to the carrier and MKS Instruments immediately. If there is no obvious damage and the continuity is correct, obtain an RMA (Return Material Authorization) number before returning the unit to MKS Instruments for service.

In production operations such as semiconductor manufacturing, verify the transducer zero (and adjust if necessary) each time the equipment is shut down for routine maintenance.

Note



The ZERO adjustment is the *only* adjustment that can be made in the field. Return the transducer to MKS Instruments for other adjustments, calibration, or servicing.

Periodically check for wear on the cables and inspect the enclosure for visible signs of damage.

Zero Adjustment

All pressure transducers require initial and periodic zero adjustments. Make these adjustments at a pressure lower than the transducer's minimum resolution to achieve the full dynamic range specified for the transducer. Refer to *Chapter Two: Installation*, page 19, for instructions on adjusting the zero setting.

Troubleshooting Chart

Symptom	Possible Cause	Solution
Overrange positive or negative signal	A shorted transducer or a damaged interconnect cable (transducer to electronics module).	Measure supply voltages at the terminal block. Inspect cable and transducer. Replace if necessary.
Measurement slowly goes positive over time	Overpressure and/or a build-up of contamination in the P _x cavity.	Return to MKS for servicing or transducer replacement.
Unstable zero output	The ambient temperature may be too high. <i>or</i> The ambient temperature is varying over a wide range.	Refer to <i>Appendix A: Product Specifications</i> , page 49, and be sure the ambient temperature is within product requirements.

Table 115: Troubleshooting Chart

Appendix A: Product Specifications

MKS Types 622C and 626C Units

Accuracy (includes non-linearity, hysteresis and non-repeatability)	0.25% of Reading standard for ranges of 1 to 1000 Torr, with option for 0.15% of reading ¹ . For ranges of < 1 Torr, standard specification is 0.50% of reading.
Ambient operating temperature range ¹	0° to 50° C (32° to 122° F) for ranges of 1 to 1000 Torr. For ranges < 1 Torr, ambient temperature range is 15° to 40°C (59° to 104°F)
CE Compliance ²	EMC Directive 2004/108/EC
RoHS (Restriction of Hazardous Substances) Compliance	Compliant to Directive 2002/95/EC
Electrical Connector 622B 626B	5-post terminal block 15-pin male D-subminiature
Fittings Standard Optional	½ inch (12.7 mm) tubulation NW16-KF, NW25-KF, mini-CF, Swagelok 8 VCR [®] female, 8 VCO [®] female
Full Scale Range (Torr)	0.10 (626C only), 0.25 (626C only), 1, 2, 10, 20, 100, 500, 1000
Input required	±15 VDC (±5%) @ 35 mA.
Materials exposed to gases	Inconel [®] and Incoloy [®] . Some optional fittings may be built from 300-series stainless steel.
Output	0 to +10 VDC into ≥ 10K ohm load
Overpressure limit without damage	45 psia (310 kPa)
Temperature coefficients Zero Span	0.005% F.S./°C ³ 0.04% Reading/°C
Time constant	< 20 msec
Usable measurement range	1 x 10 ⁻⁴ F.S.
Volume (Px side)	6.3 cc

¹Some specifications may vary outside this temperature range - consult factory for further information. 626C 0.10 and 0.25 T ambient operating temperature range 15°C to 40°C (59°F to 104°F)

²An overall metal braided shielded cable, properly grounded at both ends, is required during use.

³For Types 622C/626C 2 Torr transducers, the zero temp. coef. is 0.010% F.S./°C.
For Types 622C/626C 1 Torr transducers, the zero temp. coef. is 0.015% F.S./°C.
For Type 626C 0.10 Torr transducers, the zero temp. coef. is 0.02% F.S./°C.

Due to continuing research and development activities, these specifications are subject to change without notice.

Type 623B Transducer

Accuracy (including non-linearity, hysteresis, and non-repeatability)	± 0.25% of Reading Optional: 0.15% of Reading
Ambient operating temperature range <i>Sensor operating temperature is ambient</i>	0° to 50° C (32° to 122° F)
CE Compliance ⁴	EMC Directive 2004/108/EC
RoHS (Restriction of Hazardous Substances) Compliance	Compliant to Directive 2002/95/EC
Fittings Standard Optional	½” diameter (12.7 mm) tubulation Swagelok® 8-VCR® (female), 1.33 inch (33.7 mm) Conflat® (rotatable), NW16-KF, NW25-KF, Swagelok 8-VCO® (female)
Full Scale Pressure ranges (mmHg)	10, 20, 100, 500, 1000
Input power required	±15 VDC (±5%) @ 75 mA
Materials exposed to gases	Inconel® and Incoloy®. Some optional fittings may be built from 300-series stainless steel.
Output	0 to 10 VDC into ≥ 10k ohm load
Overpressure limit without damage	45 psia (310 kPa)
Temperature Coefficients Zero Span	0.005% FS / ° C 0.04% Reading / ° C
Time constant	< 20 msec
Trip points	Two process trip point relays, each adjustable from 0.1% to 100% of FS, SPDT contacts rated at 1 A @ 30 VDC or 0.5 A @ 30 VAC resistive 0 to 10 VDC output proportional to each trip point, 12.5K ohm maximum source impedance. Relays are UL-listed and CSA-approved (UL file E41515 and CSA file LR24825).
Useable measurement range	1 x 10 ⁻⁴ FS
Volume (Px side)	6.3 cc

Due to continuing research and development activities, these specifications are subject to change without notice.

⁴An overall metal braided shielded cable, properly grounded at both ends, is required during use.

Appendix B: Model Code Explanation

Model Code

The options of your unit are identified in the model code. The model code is identified as follows:

62XBXXXYYZ

where:

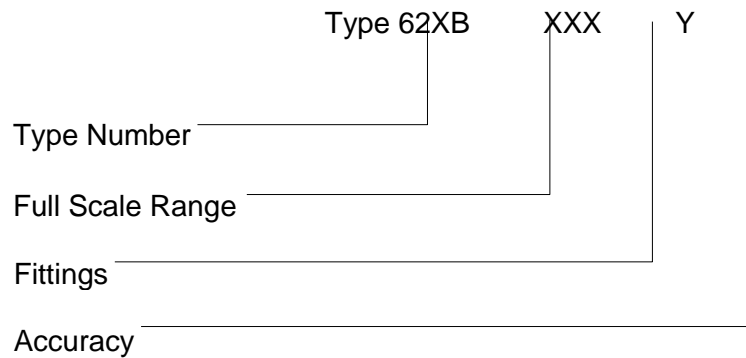

Type Number (62XB)

This designates the model number of the instrument.

622B - Terminal block electrical connector

623B – Two (2) trip relays with two (2) terminal block electrical connectors

626C – 15-pin D-subminiature electrical connector

Full Scale Range (XXX)

The full scale range is indicated by a three character code.

Full Scale Range	Ordering Code
0.1*	.1T
0.25*	RET
1**	01T
2**	02T
10	11T
20	21T
100	12T
500	52T
1000	13T

**Available on 626C models only*

***Available on 622C and 626C models only*

Fittings (Y)

The choice of fittings is designated by a single letter code.

Fittings	Ordering Code
½ inch (12.7 mm) tubulation	A
Swagelok 8-VCR, female	B
1.33 inch (33.8 mm) O.D. CF, rotatable	C
NW16-KF	D
Swagelok 8-VCO, female	E
NW25-KF	Q

Accuracy (Z)

The accuracy is designated by a single number code.

Accuracy	Ordering Code
±0.15% of Reading, optional for Type 622B, 623B, and 626C (10, 100 and 1000 Torr ranges only)	D
±0.25% of Reading, standard for Type 622C and 626C with ranges of 1 – 1000 Torr, all 623B models	E
±0.5% of Reading, standard for Types 626C with 0.1 and 0.25 Torr ranges	F

Index

- Accuracy, 17, 52
- Cabling, 20–22
- CE compliance, 20, 47
- Coarse Zero adjustment, 26–27
- Companion products, 19
- Connectors, 30
- Customer support, 18
- Dimensions, 28
- Electrical information, 17, 29–32
- Endcap, 35
- Fittings, 24, 52
- Full scale range, 17, 52
- Grounding, 29
- Hysteresis
 - description of, 35–36
 - trippoint, 42
- Interface cables, 20–22
- Maintenance, 44
- Manual organization, 18
- Model code, 51
- Orientation, 25
- Pinout, 30
- Pressure
 - lowest for control, 34
 - lowest for reading, 34
- Returning the product, 18, 19, 44
- RoHS (Restriction of Hazardous Substances), 17, 47, 48
- Safety information, 1–16
- Sensor, 33
- Setup, 25
- Signal Conditioner/Electronics, 33
- Specifications, 48
- Trip points
 - hysteresis, 42
 - jumper direction, 38
 - pot adjustment, 38
 - voltage, 37
- Troubleshooting, 45
- Type 622 transducer, 47
- Type 626 transducer, 47
- Unpacking the unit, 19
- Vibration, 25
- Warm up time, 25, 34
- Warranty, 24
- Zero adjustment, 25–26, 44