



# MKS Baratron® Type 220D Absolute and Differential Pressure Transducer

## Instruction Manual

2 Technology Drive  
Andover, MA, USA  
01810

Main: 978.645.5500  
USA: 800.227.8766  
[www.mksinst.com](http://www.mksinst.com)

120364-P1  
Rev. C, 03/13  
Instruction Manual



## WARRANTY

### Type 220D Equipment

MKS Instruments, Inc. (**MKS**) warrants that the equipment described above (the "equipment") manufactured by **MKS** shall be free from defects in materials and workmanship for a period of one year from date of shipment and will for a period of two years from the date of shipment, correctly perform all date-related operations, including without limitation accepting data entry, sequencing, sorting, comparing, and reporting, regardless of the date the operation is performed or the date involved in the operation, provided that, if the equipment exchanges data or is otherwise used with equipment, software, or other products of others, such products of others themselves correctly perform all date-related operations and store and transmit dates and date-related data in a format compatible with **MKS** equipment. THIS WARRANTY IS **MKS'** SOLE WARRANTY CONCERNING DATE-RELATED OPERATIONS.

For the period commencing with the date of shipment of this equipment and ending one year later in the case of defects in materials and workmanship, but two years later in the case of failure to comply with the date-related operations warranty, **MKS** will, at its option, either repair or replace any part which is defective in materials or workmanship or with respect to the date-related operations warranty without charge to the purchaser. The foregoing shall constitute the exclusive and sole remedy of the purchaser for any breach by **MKS** of this warranty.

The purchaser, before returning any equipment covered by this warranty, which is asserted to be defective by the purchaser, shall make specific written arrangements with respect to the responsibility for shipping the equipment and handling any other incidental charges with the **MKS** sales representative or distributor from which the equipment was purchased or, in the case of a direct purchase from **MKS**, with the **MKS** home office in Andover, Massachusetts, USA.

This warranty does not apply to any equipment which has not been installed and used in accordance with the specifications recommended by **MKS** for the proper and normal use of the equipment. **MKS** shall not be liable under any circumstances for indirect, special, consequential, or incidental damages in connection with, or arising out of, the sale, performance, or use of the equipment covered by this warranty.

**MKS** recommends that all **MKS** pressure and flow products be calibrated periodically (typically every 6 to 12 months) to ensure accurate readings. When a product is returned to **MKS** for this periodic re-calibration it is considered normal preventative maintenance not covered by any warranty.

THIS WARRANTY IS IN LIEU OF ALL OTHER RELEVANT WARRANTIES, EXPRESSED OR IMPLIED, INCLUDING THE IMPLIED WARRANTY OF MERCHANTABILITY AND THE IMPLIED WARRANTY OF FITNESS FOR A PARTICULAR PURPOSE, AND ANY WARRANTY AGAINST INFRINGEMENT OF ANY PATENT.

04/09

120364-P1

## SPECIAL NOTICE

This warranty is void if the product is installed using single or double metal ferrule compression type vacuum fittings, shown below. These fittings are commonly tightened incorrectly, causing damage to the pressure sensor.

Single Ferrule

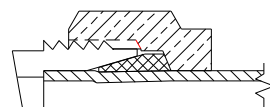

Double Ferrule

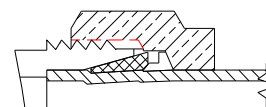

# MKS Baratron® Type 220D Pressure Transducer

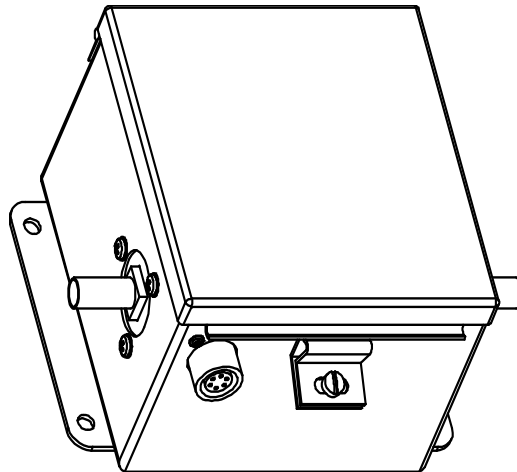

*Copyright © 2013 by MKS Instruments, Inc.*

*All rights reserved. No part of this work may be reproduced or transmitted in any form or by any means, electronic or mechanical, including photocopying and recording, or by any information storage or retrieval system, except as may be expressly permitted in writing by MKS Instruments, Inc.*

*Printed in the United States of America*

Baratron® is a registered trademark of MKS Instruments, Inc., Andover, MA, USA.

Swagelok® and VCR® are registered trademarks of Swagelok Company, Solon, OH, USA.

Inconel® is a registered trademark of Inco Alloys International, Inc., Huntington, WV, USA.

Bendix® is a registered trademark of Amphenol Corp., Bendix Connector Corp., Sidney, NY, USA.

Conflat® is a registered trademark of Varian Associates, Inc., Lexington, MA, USA.

*Some Baratron® products may not be exported to many end user countries without both US and local government export licenses under ECCN 2B230.*

## Table of Contents

Safety Information .....	1
Symbols Used in This Instruction Manual.....	1
Symbols Found on the Unit .....	2
Safety Procedures and Precautions .....	3
Sicherheitshinweise.....	5
In dieser Betriebsanleitung vorkommende Symbole .....	5
Am Gerät angebrachte Symbole .....	6
Sicherheitsvorschriften und Vorsichtsmaßnahmen.....	7
Informations relatives à la sécurité .....	9
Symboles utilisés dans ce manuel d'utilisation .....	9
Symboles apparaissant sur l'appareil .....	10
Mesures de sécurité et mises en garde .....	11
Información sobre seguridad.....	13
Símbolos usados en el manual de instrucciones .....	13
Símbolos que aparecen en la unidad .....	14
Procedimientos y precauciones de seguridad .....	15
Chapter One: General Information .....	17
Introduction.....	17
How This Manual is Organized .....	18
Customer Support .....	18
Chapter Two: Installation .....	19
How To Unpack the Type 220 Unit.....	19
Unpacking Checklist.....	19
Interface Cables .....	19
Generic Shielded Cable Description .....	21
Product Location and Requirements.....	22
Operating Environmental Requirements.....	22
Safety Conditions.....	22
Setup .....	23

Dimensions .....	23
Mounting Instructions.....	25
Electrical Connections .....	26
Chapter Three: Overview.....	29
Circuit Description.....	29
Sensor.....	29
Power Supplies .....	30
DC Powered Version .....	30
AC Powered Version .....	30
Current Output .....	30
Overrange Condition.....	30
Labels.....	31
Fuse and Line Voltage Information .....	31
Chapter Four: Operation .....	33
How To Zero the Type 220 Transducer.....	33
Chapter Five: Maintenance.....	35
General Information.....	35
How To Clean the Unit.....	35
How To Change the Fuse(s) .....	35
Appendix A: Product Specifications.....	37
Common Specifications .....	37
AC Version Specifications.....	38
DC Version Specifications.....	38
Appendix B: Model Code Explanation.....	39
Model Code.....	39
Index .....	41

## List of Figures and Tables

### **Figures**

Figure 1: Top View of the 220 Transducer .....	23
Figure 2: Side View of the 220 Transducer .....	24
Figure 3: Back View of the 220 Transducer (AC Powered Unit shown) .....	24
Figure 4: Front View of the 220 Transducer (AC Powered Unit shown) .....	24
Figure 5: Preferred Mounting Orientation (Top View) .....	25
Figure 6: Location of the Fuses, Power Connector, and Line Voltage Switch .....	26
Figure 7: Block Diagram of the Type 220 Gauge .....	29
Figure 8: Serial Number Label (AC version shown) .....	31
Figure 9: Fuse and Line Voltage Information .....	31
Figure 10: Zero Potentiometer on the Amplifier Board .....	34

### **Tables**

Table 1: Definition of Symbols Found on the Unit .....	2
Tabelle 2: Definitionen der am Gerät angebrachten Symbole .....	6
Tableau 3: Définition des symboles apparaissant sur l'appareil .....	10
Tabla 4: Definición de los símbolos que aparecen en la unidad .....	14
Table 5: Interface Cables .....	20
Table 6: Fuse Information .....	26
Table 7: Output Connector Pinout for AC Powered Units .....	27
Table 8: Output Connector Pinout for DC Powered Units .....	28
Table 9: Maximum Pressure Reading for Zero Adjustment .....	33





## Safety Information

### Symbols Used in This Instruction Manual

Definitions of WARNING, CAUTION, and NOTE messages used throughout the manual.

---

**Warning**  The **WARNING** sign denotes a hazard. It calls attention to a procedure, practice, condition, or the like, which, if not correctly performed or adhered to, could result in injury to personnel.

---

---

**Caution**  The **CAUTION** sign denotes a hazard. It calls attention to an operating procedure, practice, or the like, which, if not correctly performed or adhered to, could result in damage to or destruction of all or part of the product.

---

---

**Note**  The **NOTE** sign denotes important information. It calls attention to a procedure, practice, condition, or the like, which is essential to highlight.

---

## Symbols Found on the Unit

The following table describes symbols that may be found on the unit.





















Definition of Symbols Found on the Unit			
  Off (Supply) IEC 417, No.5008	 Off (Supply) IEC 417, No.5008	  Protective earth (ground) IEC 417, No.5019	 Protective earth (ground) IEC 417, No.5019
   Direct current IEC 417, No.5021	  Direct current IEC 417, No.5021	  Direct current IEC 417, No.5021	 Alternating current IEC 417, No.5032
 Both direct and alternating current IEC 417, No.5033-a	  Three phase alternating current IEC 617-2 No.020206	 Three phase alternating current IEC 617-2 No.020206	
 Caution, refer to accompanying documents ISO 3864, No.B.3.1	 Caution, risk of electric shock ISO 3864, No.B.3.6	 Caution, hot surface IEC 417, No.5041	

Table 1: Definition of Symbols Found on the Unit

## **Safety Procedures and Precautions**

**The following general safety precautions must be observed during all phases of operation of this instrument. Failure to comply with these precautions or with specific warnings elsewhere in this manual violates safety standards of intended use of the instrument and may impair the protection provided by the equipment. MKS Instruments, Inc. assumes no liability for the customer's failure to comply with these requirements.**

### **DO NOT SUBSTITUTE PARTS OR MODIFY INSTRUMENT**

Do not install substitute parts or perform any unauthorized modification to the instrument. Return the instrument to an MKS Calibration and Service Center for service and repair to ensure that all safety features are maintained.

### **SERVICE BY QUALIFIED PERSONNEL ONLY**

Operating personnel must not remove instrument covers. Component replacement and internal adjustments must be made by qualified service personnel only.

### **GROUNDING THE PRODUCT**

This product is grounded through the grounding conductor of the power cord. To avoid electrical shock, plug the power cord into a properly wired receptacle before connecting it to the product input or output terminals. A protective ground connection by way of the grounding conductor in the power cord is essential for safe operation.

### **DANGER ARISING FROM LOSS OF GROUND**

Upon loss of the protective-ground connection, all accessible conductive parts (including knobs and controls that may appear to be insulating) can render an electrical shock.

### **GROUND AND USE PROPER ELECTRICAL FITTINGS**

Dangerous voltages are contained within this instrument. All electrical fittings and cables must be of the type specified, and in good condition. All electrical fittings must be properly connected and grounded.

### **USE THE PROPER POWER CORD**

Use only a power cord that is in good condition and which meets the input power requirements specified in the manual.

Use only a detachable cord set with conductors that have a cross-sectional area equal to or greater than 0.75 mm<sup>2</sup>. The power cable should be approved by a qualified agency such as VDE, Semko, or SEV.

**USE THE PROPER POWER SOURCE**

This product is intended to operate from a power source that does not apply more voltage between the supply conductors, or between either of the supply conductors and ground, than that specified in the manual.

**USE THE PROPER FUSE**

Use only a fuse of the correct type, voltage rating, and current rating, as specified for your product.

**DO NOT OPERATE IN EXPLOSIVE ATMOSPHERES**

To avoid explosion, do not operate this product in an explosive environment unless it has been specifically certified for such operation.

**HIGH VOLTAGE DANGER**

High voltage is present in the cable, and in the sensor when the controller is turned on.

## Sicherheitshinweise

### In dieser Betriebsanleitung vorkommende Symbole

Definition der mit WARNUNG!, VORSICHT! und HINWEIS überschriebenen Abschnitte in dieser Betriebsanleitung.

**Warnung!**



---

Das Symbol **WARNUNG!** weist auf eine Gefahrenquelle hin. Es macht auf einen Arbeitsablauf, eine Arbeitsweise, einen Zustand oder eine sonstige Gegebenheit aufmerksam, deren unsachgemäße Ausführung bzw. ungenügende Berücksichtigung zu Körperverletzung führen kann.

---

**Vorsicht!**



---

Das Symbol **VORSICHT!** weist auf eine Gefahrenquelle hin. Es macht auf einen Bedienungsablauf, eine Arbeitsweise oder eine sonstige Gegebenheit aufmerksam, deren unsachgemäße Ausführung bzw. ungenügende Berücksichtigung zu einer Beschädigung oder Zerstörung des Produkts oder von Teilen des Produkts führen kann.

---

**Hinweis**



---

Das Symbol **HINWEIS** weist auf eine wichtige Mitteilung hin, die auf einen Arbeitsablauf, eine Arbeitsweise, einen Zustand oder eine sonstige Gegebenheit von besonderer Wichtigkeit aufmerksam macht.

---

## Am Gerät angebrachte Symbole

Der untenstehenden Tabelle sind die Bedeutungen der Symbole zu entnehmen, die an dem Gerät angebracht sind.















Definitionen der am Gerät angebrachten Symbole			
			
Ein (Netz) IEC 417, Nr. 5007	Aus (Netz) IEC 417, Nr. 5008	Erde IEC 417, Nr. 5017	Schutzleiter IEC 417, Nr. 5019
			
Rahmen oder Chassis IEC 417, Nr. 5020	Äquipotentialanschluß IEC 417, Nr. 5021	Gleichstrom IEC 417, Nr. 5031	Wechselstrom IEC 417, Nr. 5032
			
Wechselstrom und Gleichstrom IEC 417, Nr. 5033-a	Geräteklasse II IEC 417, Nr. 5172-a	Drehstrom IEC 617-2 Nr. 020206	
			
Vorsicht! Bitte Begleitdokumente lesen! ISO 3864, Nr. B.3.1	Vorsicht! Stromschlaggefahr! ISO 3864, Nr. B.3.6	Vorsicht! Heiße Fläche! IEC 417, Nr. 5041	

Tabelle 2: Definitionen der am Gerät angebrachten Symbole

## **Sicherheitsvorschriften und Vorsichtsmaßnahmen**

**Die untenstehenden allgemeinen Sicherheitsvorschriften sind bei allen Betriebsphasen dieses Instruments zu befolgen. Jede Mißachtung dieser Sicherheitsvorschriften oder sonstiger spezifischer Warnhinweise in dieser Betriebsanleitung stellt eine Zuwiderhandlung der für dieses Instrument geltenden Sicherheitsstandards dar und kann die an diesem Instrument vorgesehenen Schutzvorrichtungen unwirksam machen. MKS Instruments, Inc. haftet nicht für eine Mißachtung dieser Sicherheitsvorschriften seitens des Kunden.**

### **Keine Teile austauschen und keine Veränderungen vornehmen!**

Bauen Sie in das Instrument keine Ersatzteile ein, und nehmen Sie keine eigenmächtigen Änderungen am Gerät vor! Schicken Sie das Instrument zu Wartungs- und Reparaturzwecken an einen MKS-Kalibrierungs- und -Kundendienst ein! Dadurch wird sicher gestellt, daß alle Sicherheitseinrichtungen voll funktionsfähig bleiben.

### **Wartung nur durch qualifizierte Fachleute!**

Das Gehäuse des Instruments darf vom Bedienpersonal nicht geöffnet werden. Das Auswechseln von Bauteilen und das Vornehmen von internen Einstellungen ist nur von qualifizierten Fachleuten durchzuführen.

### **Produkt erden!**

Dieses Produkt ist mit einer Erdleitung und einem Schutzkontakt am Netzstecker versehen. Um der Gefahr eines elektrischen Schlages vorzubeugen, ist das Netzkabel an einer vorschriftsmäßig geerdeten Schutzkontaktsteckdose anzuschließen, bevor es an den Eingangs- bzw. Ausgangsklemmen des Produkts angeschlossen wird. Das Instrument kann nur sicher betrieben werden, wenn es über den Erdleiter des Netzkabels und einen Schutzkontakt geerdet wird.

### **Gefährdung durch Verlust der Schutzerdung!**

Geht die Verbindung zum Schutzleiter verloren, besteht an sämtlichen zugänglichen Teilen aus stromleitendem Material die Gefahr eines elektrischen Schlages. Dies gilt auch für Knöpfe und andere Bedienelemente, die dem Anschein nach isoliert sind.

**Erdung und Verwendung geeigneter elektrischer Armaturen!**

In diesem Instrument liegen gefährliche Spannungen an. Alle verwendeten elektrischen Armaturen und Kabel müssen dem angegebenen Typ entsprechen und sich in einwand-freiem Zustand befinden. Alle elektrischen Armaturen sind vorschriftsmäßig anzubringen und zu erden.

**Richtiges Netzkabel verwenden!**

Das verwendete Netzkabel muß sich in einwandfreiem Zustand befinden und den in der Betriebsanleitung enthaltenen Anschlußwerten entsprechen.

Das Netzkabel muß abnehmbar sein. Der Querschnitt der einzelnen Leiter darf nicht weniger als  $0,75 \text{ mm}^2$  betragen. Das Netzkabel sollte einen Prüfvermerk einer zuständigen Prüfstelle tragen, z.B. VDE, Semko oder SEV.

**Richtige Stromquelle verwenden!**

Dieses Produkt ist für eine Stromquelle vorgesehen, bei der die zwischen den Leitern bzw. zwischen jedem der Leiter und dem Masseleiter anliegende Spannung den in dieser Betriebsanleitung angegebenen Wert nicht überschreitet.

**Richtige Sicherung benutzen!**

Es ist eine Sicherung zu verwenden, deren Typ, Nennspannung und Nennstromstärke den Angaben für dieses Produkt entsprechen.

**Gerät nicht in explosiver Atmosphäre benutzen!**

Um der Gefahr einer Explosion vorzubeugen, darf dieses Gerät nicht in der Nähe explosiver Stoffe eingesetzt werden, sofern es nicht ausdrücklich für diesen Zweck zertifiziert worden ist.

**Hochspannungsgefahr!**

Bei eingeschaltetem Steuerteil liegt im Kabel und im Sensor Hochspannung an.



## Informations relatives à la sécurité

### Symboles utilisés dans ce manuel d'utilisation

Définition des indications AVERTISSEMENT, ATTENTION et REMARQUE utilisées dans ce manuel.

---

#### Avertissement



L'indication **AVERTISSEMENT** signale un danger potentiel. Elle est destinée à attirer l'attention sur une procédure, une utilisation, une situation ou toute autre chose présentant un risque de blessure en cas d'exécution incorrecte ou de non-respect des consignes.

---

---

#### Attention



L'indication **ATTENTION** signale un danger potentiel. Elle est destinée à attirer l'attention sur une procédure, une utilisation, une situation ou toute autre chose présentant un risque d'endommagement ou de dégât d'une partie ou de la totalité de l'appareil en cas d'exécution incorrecte ou de non-respect des consignes.

---

---

#### Remarque



L'indication **REMARQUE** signale des informations importantes. Elle est destinée à attirer l'attention sur une procédure, une utilisation, une situation ou toute autre chose présentant un intérêt particulier.

---

## Symboles apparaissant sur l'appareil

Le tableau suivant décrit les symboles apparaissant sur l'appareil.















Définition des symboles apparaissant sur l'appareil			
			
Marche (sous tension) IEC 417, No. 5007	Arrêt (hors tension) IEC 417, No. 5008	Terre (masse) IEC 417, No. 5017	Terre de protection (masse) IEC 417, No. 5019
			
Masse IEC 417, No. 5020	Equipotentialité IEC 417, No. 5021	Courant continu IEC 417, No. 5031	Courant alternatif IEC 417, No. 5032
			
Courant continu et alternatif IEC 417, No. 5033-a	Matériel de classe II IEC 417, No. 5172-a	Courant alternatif triphase IEC 617-2 No. 020206	
			
Attention : se reporter à la documentation ISO 3864, No. B.3.1	Attention : risque de secousse électrique ISO 3864, No. B.3.6	Attention : surface brûlante IEC 417, No. 5041	

Tableau 3: Définition des symboles apparaissant sur l'appareil

## **Mesures de sécurité et mises en garde**

**Prendre toutes les précautions générales suivantes pendant toutes les phases d'utilisation de cet appareil. Le non-respect de ces précautions ou des avertissements contenus dans ce manuel entraîne une violation des normes de sécurité relatives à l'utilisation de l'appareil et le risque de réduire le niveau de protection fourni par l'appareil. MKS Instruments, Inc. ne prend aucune responsabilité pour les conséquences de tout non-respect des consignes de la part de ses clients.**

### **NE PAS SUBSTITUER DES PIÈCES OU MODIFIER L'APPAREIL**

Ne pas utiliser de pièces détachées autres que celles vendues par MKS Instruments, Inc. ou modifier l'appareil sans l'autorisation préalable de MKS Instruments, Inc. Renvoyer l'appareil à un centre d'étalonnage et de dépannage MKS pour tout dépannage ou réparation afin de s'assurer que tous les dispositifs de sécurité sont maintenus.

### **DÉPANNAGE EFFECTUÉ UNIQUEMENT PAR UN PERSONNEL QUALIFIÉ**

L'opérateur de l'appareil ne doit pas enlever le capot de l'appareil. Le remplacement des composants et les réglages internes doivent être effectués uniquement par un personnel d'entretien qualifié.

### **MISE À LA TERRE DE L'APPAREIL**

Cet appareil est mis à la terre à l'aide du fil de terre du cordon d'alimentation. Pour éviter tout risque de secousse électrique, brancher le cordon d'alimentation sur une prise de courant correctement câblée avant de le brancher sur les bornes d'entrée ou de sortie de l'appareil. Une mise à la terre de protection à l'aide du fil de terre du cordon d'alimentation est indispensable pour une utilisation sans danger de l'appareil.

### **DANGER LIÉ À UN DÉFAUT DE TERRE**

En cas de défaut de terre, toutes les pièces conductrices accessibles (y compris les boutons de commande ou de réglage qui semblent être isolés) peuvent être source d'une secousse électrique.

### **MISE À LA TERRE ET UTILISATION CORRECTE D'ACCESSOIRES ÉLECTRIQUES**

Des tensions dangereuses existent à l'intérieur de l'appareil. Tous les accessoires et les câbles électriques doivent être conformes au type spécifié et être en bon état. Tous les accessoires électriques doivent être correctement connectés et mis à la terre.

**UTILISATION D'UN CORDON D'ALIMENTATION APPROPRIÉ**

Utiliser uniquement un cordon d'alimentation en bon état et conforme aux exigences de puissance d'entrée spécifiées dans le manuel.

Utiliser uniquement un cordon d'alimentation amovible avec des conducteurs dont la section est égale ou supérieure à 0,75 mm<sup>2</sup>. Le cordon d'alimentation doit être approuvé par un organisme compétent tel que VDE, Semko ou SEV.

**UTILISATION D'UNE ALIMENTATION APPROPRIÉE**

Cet appareil est conçu pour fonctionner en s'alimentant sur une source de courant électrique n'appliquant pas une tension entre les conducteurs d'alimentation, ou entre les conducteurs d'alimentation et le conducteur de terre, supérieure à celle spécifiée dans le manuel.

**UTILISATION D'UN FUSIBLE APPROPRIÉ**

Utiliser uniquement un fusible conforme au type, à la tension nominale et au courant nominal spécifiés pour l'appareil.

**NE PAS UTILISER DANS UNE ATMOSPHÈRE EXPLOSIVE**

Pour éviter tout risque d'explosion, ne pas utiliser l'appareil dans une atmosphère explosive à moins qu'il n'ait été approuvé pour une telle utilisation.

**DANGER DE HAUTE TENSION**

Une haute tension est présente dans le câble et dans le capteur lorsque le contrôleur est sous tension.

## Información sobre seguridad

### Símbolos usados en el manual de instrucciones

Definiciones de los mensajes de ADVERTENCIA, PRECAUCIÓN Y OBSERVACIÓN usados en el manual.

---

**Advertencia**  El símbolo de **ADVERTENCIA** indica un riesgo. **Pone de relieve un procedimiento, práctica, condición, etc., que, de no realizarse u observarse correctamente, podría causar lesiones a los empleados.**

---



---

**Precaución**  El símbolo de **PRECAUCIÓN** indica un riesgo. **Pone de relieve un procedimiento, práctica, etc., de tipo operativo que, de no realizarse u observarse correctamente, podría causar desperfectos al instrumento, o llegar incluso a causar su destrucción total o parcial.**

---



---

**Observación**  El símbolo de **OBSERVACIÓN** indica información de importancia. **Pone de relieve un procedimiento, práctica, condición, etc., cuyo conocimiento resulta esencial.**

---

## Símbolos que aparecen en la unidad

En la tabla que figura a continuación se indican los símbolos que aparecen en la unidad.















Definición de los símbolos que aparecen en la unidad			
			
Encendido (alimentación eléctrica) IEC 417, N.º 5007	Apagado (alimentación eléctrica) IEC 417, N.º 5008	Puesta a tierra IEC 417, N.º 5017	Protección a tierra IEC 417, N.º 5019
			
Caja o chasis IEC 417, N.º 5020	Equipotencialidad IEC 417, N.º 5021	Corriente continua IEC 417, N.º 5031	Corriente alterna IEC 417, N.º 5032
			
Corriente continua y alterna IEC 417, N.º 5033-a	Equipo de clase II IEC 417, N.º 5172-a	Corriente alterna trifásica IEC 617-2 N.º 020206	
			
Precaución. Consultar los documentos adjuntos ISO 3864, N.º B.3.1	Precaución. Riesgo de descarga eléctrica ISO 3864, N.º B.3.6	Precaución. Superficie caliente IEC 417, N.º 5041	

Tabla 4: Definición de los símbolos que aparecen en la unidad

## **Procedimientos y precauciones de seguridad**

**Las precauciones generales de seguridad que figuran a continuación deben observarse durante todas las fases de funcionamiento del presente instrumento. La no observancia de dichas precauciones, o de las advertencias específicas a las que se hace referencia en el manual, contraviene las normas de seguridad referentes al uso previsto del instrumento y podría impedir la protección que proporciona el instrumento. MKS Instruments, Inc., no asume responsabilidad alguna en caso de que el cliente haga caso omiso de estos requerimientos.**

### **NO UTILIZAR PIEZAS NO ORIGINALES NI MODIFICAR EL INSTRUMENTO**

No se debe instalar piezas que no sean originales ni modificar el instrumento sin autorización. Para garantizar que las prestaciones de seguridad se observen en todo momento, enviar el instrumento al Centro de servicio y calibración de MKS cuando sea necesaria su reparación y servicio de mantenimiento.

### **REPARACIONES EFECTUADAS ÚNICAMENTE POR TÉCNICOS ESPECIALIZADOS**

Los operarios no deben retirar las cubiertas del instrumento. El cambio de piezas y los reajustes internos deben efectuarlos únicamente técnicos especializados.

### **PUESTA A TIERRA DEL INSTRUMENTO**

Este instrumento está puesto a tierra por medio del conductor de tierra del cable eléctrico. Para evitar descargas eléctricas, enchufar el cable eléctrico en una toma debidamente instalada, antes de conectarlo a las terminales de entrada o salida del instrumento. Para garantizar el uso sin riesgos del instrumento resulta esencial que se encuentre puesto a tierra por medio del conductor de tierra del cable eléctrico.

### **PELIGRO POR PÉRDIDA DE LA PUESTA A TIERRA**

Si se pierde la conexión protectora de puesta a tierra, todas las piezas conductoras a las que se tiene acceso (incluidos los botones y mandos que pudieran parecer estar aislados) podrían producir descargas eléctricas.

### **PUESTA A TIERRA Y USO DE ACCESORIOS ELÉCTRICOS ADECUADOS**

Este instrumento funciona con voltajes peligrosos. Todos los accesorios y cables eléctricos deben ser del tipo especificado y mantenerse en buenas condiciones. Todos los accesorios eléctricos deben estar conectados y puestos a tierra del modo adecuado.

**USAR EL CABLE ELÉCTRICO ADECUADO**

Usar únicamente un cable eléctrico que se encuentre en buenas condiciones y que cumpla los requisitos de alimentación de entrada indicados en el manual.

Usar únicamente un cable desmontable instalado con conductores que tengan un área de sección transversal equivalente o superior a 0,75mm<sup>2</sup>. El cable eléctrico debe estar aprobado por una entidad autorizada como, por ejemplo, VDE, Semko o SEV.

**USAR LA FUENTE DE ALIMENTACIÓN ELÉCTRICA ADECUADA**

Este instrumento debe funcionar a partir de una fuente de alimentación eléctrica que no aplique más voltaje entre los conductores de suministro, o entre uno de los conductores de suministro y la puesta a tierra, que el que se especifica en el manual.

**USAR EL FUSIBLE ADECUADO**

Usar únicamente un fusible del tipo, clase de voltaje y de corriente adecuados, según lo que se especifica para el instrumento.

**EVITAR SU USO EN ENTORNOS EXPLOSIVOS**

Para evitar el riesgo de explosión, no usar este instrumento o en un entorno explosivo, a no ser que haya sido certificado para tal uso.

**PELIGRO POR ALTO VOLTAJE**

Cuando el controlador está encendido, se registra alto voltaje en el cable y en el sensor.



## Chapter One: General Information

### Introduction

**Note**

---

Some Baratron<sup>®</sup> products may not be exported to many end user countries without both US and local government export licenses under ECCN 2B230.

---

The MKS Type 220D Pressure Transducer is a self-contained unit with the sensor, associated electronics, and power supply (AC version only) mounted in a NEMA 1 enclosure. Both AC and DC versions are available.

The sensor is made up of three parts:

- Tensioned Inconel<sup>®</sup> diaphragm
- Single ceramic-based electrode
- Reference side cover through which feedthrough terminals make connections to the electrode within the reference cavity

The electronic circuitry contains those components necessary to convert a change in capacitance (caused by diaphragm deflection) to a linear  $\pm 10$  VDC signal. Both the AC and DC powered versions of the Type 220D transducer carry a CE Mark signifying compliance with current CE Directives.

Both absolute and differential sensors are available. In the case of the absolute transducer, the reference ( $P_R$ ) side is pumped to  $10^{-7}$  Torr, sealed, and equipped with a chemical getter material to maintain high vacuum. On differential models, the reference side of the sensor is equipped with a second sensor tube that can be connected to another vacuum source, or left open to provide a reference to local atmospheric pressure. The measurement ( $P_X$ ) port is designed to handle a wide range of corrosive and dirty gases. The two ports ( $P_X$  and  $P_R$ ) are asymmetrical, therefore, the pressure in the reference port may lag behind the pressure measurement port slightly. This lag may create an error in systems with rapid changes in line or reference pressure.

## **How This Manual is Organized**

This manual is designed to provide instructions on how to set up, install, and operate a Type 220 unit.

**Before installing your Type 220 unit in a system and/or operating it, carefully read and familiarize yourself with all precautionary notes in the *Safety Messages and Procedures* section at the front of this manual. In addition, observe and obey all WARNING and CAUTION notes provided throughout the manual.**

*Chapter One: General Information*, (this chapter) introduces the product and describes the organization of the manual.

*Chapter Two: Installation*, explains the environmental requirements, describes how to mount the instrument in your system

*Chapter Three: Overview*, gives a brief description of the instrument and its functionality.

*Chapter Four: Operation*, describes how to operate the instrument.

*Chapter Five: Maintenance*, describes how to perform the general maintenance necessary to keep the instrument operating properly.

*Appendix A: Product Specifications*, lists the specifications of the product.

*Appendix B: Model Code Explanation*, describes the model code used to order the unit.

## **Customer Support**

Standard maintenance and repair services are available at all of our regional MKS Calibration and Service Centers, listed on the back cover. In addition, MKS accepts the instruments of other manufacturers for recalibration using the Primary and Transfer Standard calibration equipment located at all of our regional service centers. Should any difficulties arise in the use of your Type 220 instrument, or to obtain information about companion products MKS offers, contact any authorized MKS Calibration and Service Center. If it is necessary to return the instrument to MKS, please obtain an RMA (Return Material Authorization) number from the MKS Calibration and Service Center before shipping. The RMA Number expedites handling and ensures proper servicing of your instrument.

Please refer to the inside of the back cover of this manual for a list of MKS Calibration and Service Centers.

---

### **Warning**



**All returns to MKS Instruments must be free of harmful, corrosive, radioactive, or toxic materials.**

---

## Chapter Two: Installation

### How To Unpack the Type 220 Unit

MKS has carefully packed the Type 220 unit so that it will reach you in perfect operating order. Upon receiving the unit, however, you should check for defects, cracks, broken connectors, etc., to be certain that damage has not occurred during shipment.

**Note**

---

Do *not* discard any packing materials until you have completed your inspection and are sure the unit arrived safely.

---

If you find any damage, notify your carrier and MKS immediately. If it is necessary to return the unit to MKS, obtain an RMA (Return Material Authorization) number from the MKS Service Center before shipping. Please refer to the inside of the back cover of this manual for a list of MKS Calibration and Service Centers.

**Caution**

---

**Only qualified individuals should perform the installation and any user adjustments. They must comply with all the necessary ESD and handling precautions while installing and adjusting the instrument. Proper handling is essential when working with all highly sensitive precision electronic instruments.**

---

### Unpacking Checklist

***Standard Equipment:***

- Type 220 Unit
- Type 220 Instruction Manual (this book)

***Optional Equipment:***

- Electrical Connector Accessories Kit: 220D-K1, that contains a mating Bendix® connector.
- Interface cables (Refer to *Interface Cables*, page 19, for details.)

### Interface Cables

*As of July 20, 2009, most products shipped to the European Community must comply with the EMC Directive 2004/108/EC, which covers radio frequency emissions and immunity tests. In addition, as of January 1, 1997, some products shipped to the European Community must also*

*comply with the Product Safety Directive 92/59/EC and Low Voltage Directive 73/23/EC, which cover general safety practices for design and workmanship. MKS products that meet these requirements are identified by application of the CE Mark.*

To ensure compliance with EMC Directive 2004/108/EC, an overall metal braided shielded cable, properly grounded at both ends, is required during use. No additional installation requirements are necessary to ensure compliance with Directives 92/59/EC and 73/23/EC.

**Note**

1. The 220 pressure transducer is CE compliant when used with an overall metal braided, shielded cable, properly grounded at both ends.
2. To order an overall braided shielded cable, add an “S” after the cable type designation. For example to order a standard cable to connect a 220 transducer to a 146 unit, use part number CB112-10-xx; for a shielded cable, use part number CB112S-10-xx (where x = length in feet).

Table 5 lists the cables to connect to common MKS equipment.

<b>Interface Cables</b>		
<b>To Connect to A . . .</b>	<b>Use Shielded Cable . . .</b>	<b>Non-shielded Cable</b>
PDR-C-1C/2C	CB474S-1-xx	CB474-1-xx
651, 660, 1651	CB112S-10-xx	CB112-10-xx
<i>where xx denotes the cable length</i>		

Table 5: Interface Cables

### Generic Shielded Cable Description

Should you choose to manufacture your own cables for this or other instruments, follow the generic guidelines listed below:

1. The cable must have an overall metal *braided* shield, covering all wires. Neither aluminum foil nor spiral shielding will be as effective; using either may nullify regulatory compliance.
2. The connectors must have a metal case which has direct contact to the cable's shield on the whole circumference of the cable. The inductance of a flying lead or wire from the shield to the connector will seriously degrade the shield's effectiveness. The shield should be grounded to the connector before its internal wires exit.
3. With very few exceptions, the connector(s) must make good contact to the device's case (ground). "Good contact" is about 0.01 ohms; and the ground should surround all wires. Contact to ground at just one point may not suffice.
4. For shielded cables with flying leads at one or both ends; it is important at each such end, to ground the shield *before* the wires exit. Make this ground with absolute minimum length. (A  $\frac{1}{4}$  inch piece of #22 wire may be undesirably long since it has approximately 5 nH of inductance, equivalent to 31 ohms at 1000 MHz). After picking up the braid's ground, keep wires and braid flat against the case. With very few exceptions, grounded metal covers are not required over terminal strips. If one is required, it will be stated in the Declaration of Conformity or in the instruction manual.
5. In selecting the appropriate type and wire size for cables, consider:
  - A. The voltage ratings;
  - B. The cumulative  $I^2R$  heating of all the conductors (keep them safely cool);
  - C. The IR drop of the conductors, so that adequate power or signal voltage gets to the device;
  - D. The capacitance and inductance of cables which are handling fast signals, (such as data lines or stepper motor drive cables); and
  - E. That some cables may need internal shielding from specific wires to others; please see the instruction manual for details regarding this matter.

## **Product Location and Requirements**

The AC powered version of the Type 220 unit meets the following criteria:

- POLLUTION DEGREE 2 in accordance with IEC 664
- Transient overvoltages according to INSTALLATION CATEGORY II

### **Operating Environmental Requirements**

- Ambient Operating Temperature: 5° to 40° C (41° to 104° F)
- Main supply voltage fluctuations must not exceed  $\pm 10\%$  of the nominal voltage
- Ventilation requirements include sufficient air circulation
- Connect the power cord into a grounded outlet

### **Safety Conditions**

The 220 unit poses no safety risk under the following environmental conditions.

- Altitude: up to 6500 ft (2000 m)
- Maximum relative humidity: 80% for temperatures up to 31° C, decreasing linearly to 50% at 40° C

## Setup

### Dimensions

#### Note



All dimensions are listed in inches with millimeters referenced in parentheses.

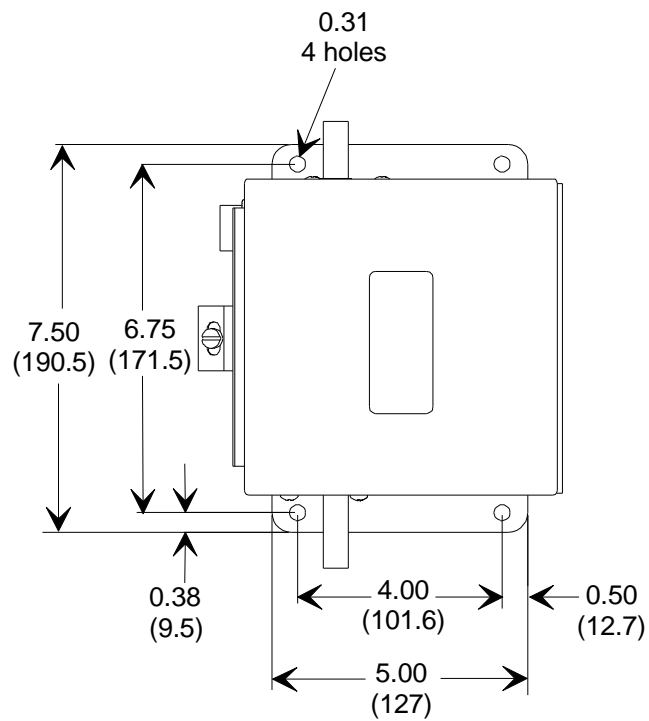

Figure 1: Top View of the 220 Transducer

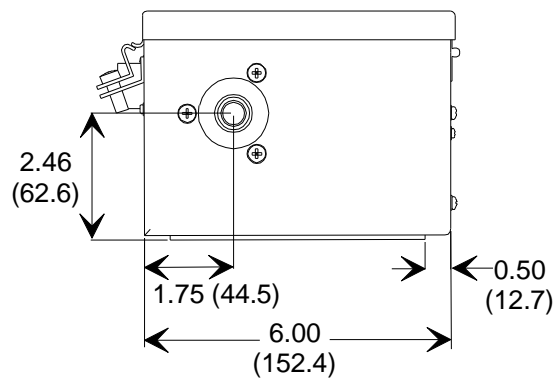

Figure 2: Side View of the 220 Transducer

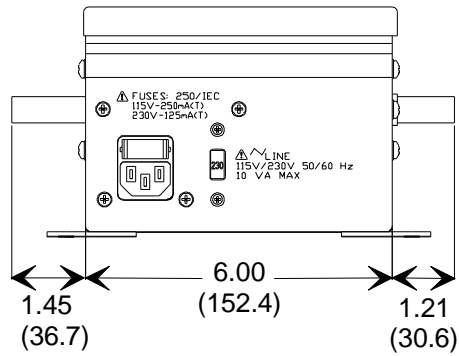

Figure 3: Back View of the 220 Transducer (AC Powered Unit shown)

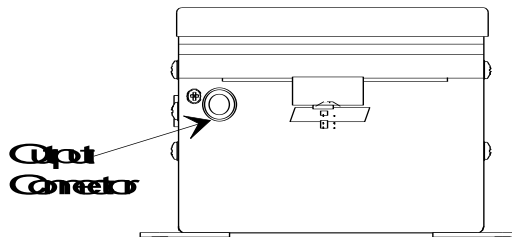

Figure 4: Front View of the 220 Transducer (AC Powered Unit shown)



### Mounting Instructions

The 220 transducer is designed to be mounted in any orientation and should be zeroed in the position in which it will be used. It is recommended, however, that the unit be mounted with the inlet port vertically downward as any foreign matter entering the pressure port will fall away from the diaphragm, thereby not affecting the measurement.

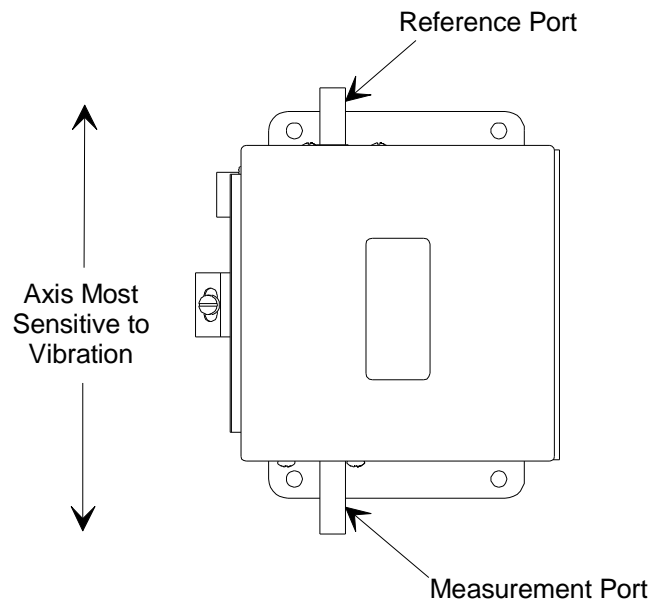

Figure 5: Preferred Mounting Orientation (Top View)

It is important that the unit be kept free from vibration as the diaphragm, when not subject to gas damping at low pressure, can be susceptible to resonance. The 1 Torr units are the most sensitive and any vibration that exists should be isolated from the unit by the use of sponge rubber pads and a bellows coupling.

## Electrical Connections

### AC Powered Units

#### Caution



1. Before plugging in the electrical outlet, verify that the position of the input voltage selector switch is in the correct position.
2. Plug the electrical connector into a properly grounded outlet. Failure to do so may compromise the performance and safe operation of the unit.

The electrical connections are located on the back of the unit, as shown in Figure 6. Input power is supplied through a 3-wire power cord (included). The line is externally fused and sent through a 2-position slide switch for selection of proper input voltage 115 or 230 VAC.

You must select the appropriate line voltage; either 115 V or 230 V. The line voltage selection switch is located adjacent to the power connector.

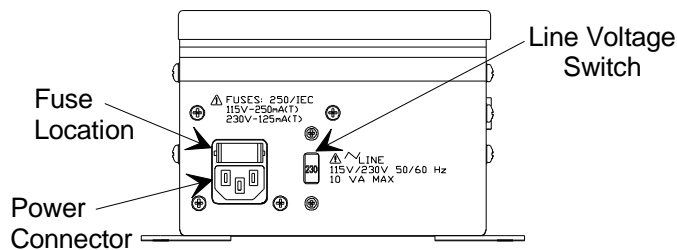

Figure 6: Location of the Fuses, Power Connector, and Line Voltage Switch

The external fuses are located above the power connector. Refer to Table 6 for the type of fuses used.

Fuse Information			
Voltage Setting (V)	Nominal Voltage Range (V)	Fuse	MKS Part Number
115	103 to 126	250 mA (T)	024-5833
230	207 to 253	125 mA (T)	024-6215

Table 6: Fuse Information

Output connections are made through the Output connector; an MS MS3106A-14S-6P connector. Refer to Figure 4, page 24, for the location of the Output connector. The pinout is listed in Table 7.

<b>Output Connector Pinout for AC Powered Units</b>	
<b>Pin Number</b>	<b>Assignment</b>
A	+ DC Voltage Output
B	DC Voltage Return
C	+ DC Current Output
D	DC Current Return
E	No Connection
F	Chassis Ground

Table 7: Output Connector Pinout for AC Powered Units

**Note**



---

The “No Connection” pin assignment refers to a pin with no internal connection.

---

**DC Powered Units**

Input power is supplied through the Output connector; an MS MS3106A-18-1S connector. Refer to Figure 4, page 24, for the location of the Output connector. The power is supplied from an external power supply which must meet the following minimum requirements.

- The output voltage must be 22 to 30 VDC
- The output current capability must exceed 600 mA
- If the power supply has fold-back current protection, it must be able to supply 250 mA into a short circuit and a straight line output from 250 mA @ 0 Volts to 500 mA @ 24 Volts to ensure inverter start-up

Table 8 lists the pinout for the Output connector.

<b>Output Connector Pinout for DC Powered Units</b>	
<b>Pin Number</b>	<b>Assignment</b>
A	+ DC Voltage Output
B	DC Voltage Return
C	+ DC Current Output
D	DC Current Return
E	24 V Input Return
F	No Connection
G	No Connection
H	No Connection
I	Chassis Ground
J	+24 V Input Voltage

Table 8: Output Connector Pinout for DC Powered Units

**Note**

The “No Connection” pin assignment refers to a pin with no internal connection.

## Chapter Three: Overview

### Circuit Description

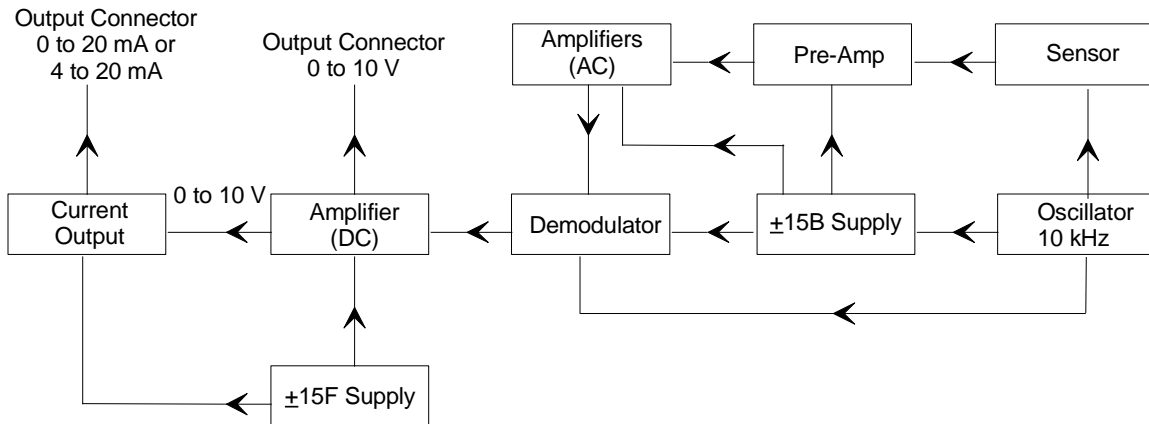

Figure 7: Block Diagram of the Type 220 Gauge

### Sensor

The variable capacitance sensor consists of a pressure inlet tube (port) connected to a small chamber in the transducer body. One wall of this chamber is an elastic metal diaphragm. The front side of the diaphragm is exposed to the gas whose pressure is to be measured. The back, or *reference* side of the diaphragm faces a rigidly mounted ceramic disc containing two electrodes. In absolute devices, the reference side is permanently evacuated ( $10^{-7}$  Torr) and its vacuum is maintained with a chemical getter system.

The diaphragm deflects with changing absolute pressure (force per unit area) independently of the gas type or composition of the measured gas. This deflection causes an imbalance of the sensor electrode capacitances since the distance to the diaphragm is now different for each electrode. The imbalance of capacitances is converted to a DC voltage in the bridge. This bridge is excited by a precision constant frequency oscillator. The resultant signal is then linearized, zeroed, and amplified via the signal conditioner electronics, to produce a precise 0 to 10 VDC signal scaled to the range of the transducer.

Zero and span stability is further increased because the sensor and bridge electronics are temperature controlled. This thermal enclosure reduces the effects of ambient temperature changes by a factor of at least 35 (i.e.  $35^{\circ}\text{C}$  change in ambient will produce less than  $1^{\circ}\text{C}$  change inside the thermal housing).

## **Power Supplies**

### **DC Powered Version**

The external 24 V supply is applied through the outer connector J1. It is then filtered and stepped down by a regulator. This voltage powers the inverter which produces two separate  $\pm 15$  V power supplies. The  $\pm 15$ F floating supply powers the voltage and current output stages to provide a DC output that is totally isolated from the chassis. The  $\pm 15$ V supply powers the remaining circuitry. For improved zero stability, the 24 VDC supply is also used to supply current for the heater circuit which maintains the sensor at a constant (normally regulated at 45° C) temperature.

### **AC Powered Version**

Power is applied through a detachable 3-wire power cord with input voltage being 115 VAC/50 - 60 Hz or 230 VAC/50 - 60 Hz. (The power cord is only supplied with 115 VAC units.) There is a switch on the back panel to select the proper input voltage. This voltage is stepped down, rectified, filtered and applied to the regulators. These regulators provide the separate  $\pm 15$  V power supplies. As in the DC version, the  $\pm 15$ V supply provides the isolated DC output while the  $\pm 15$ V supply powers the remaining circuitry. Power is taken from one side of the supply, beyond the regulator to energize the heater circuit. Refer to Table 6, page 26, for information on the type of fuses used.

### **Current Output**

A separate plug-in board, available in 0 to 20 mA and 4 to 20 mA versions, supports the current output. The 0 to 10 Volt output from the DC amplifier provides a 0 to 20 mA linear output. This output is capable of providing a linear output into a load as large as 500 ohms. The 4 to 20 mA board produces a linear output based around a 4 mA zero level. It is capable of driving the same loads as the other current board. Both boards use the  $\pm 15$ F supplies for isolated outputs.

---

**Note**

The 0 to 10 Volt output is available simultaneously with the 0 to 20 or 4 to 20 mA current output, but is not isolated from it.

---

## **Overrange Condition**

An absolute pressure transducer with full scale value below atmospheric pressure will produce an overranged output (on MKS digital display units, typically >13 VDC) unless they are connected to a vacuum system and pumped down.

## Labels

The 220 pressure transducer has a serial number label that identifies the model code and serial number, as shown in Figure 8.



Figure 8: Serial Number Label (AC version shown)

## Fuse and Line Voltage Information

The rear panel of the 220 unit contains important information on the type of fuse and the line voltage, as shown in Figure 9.

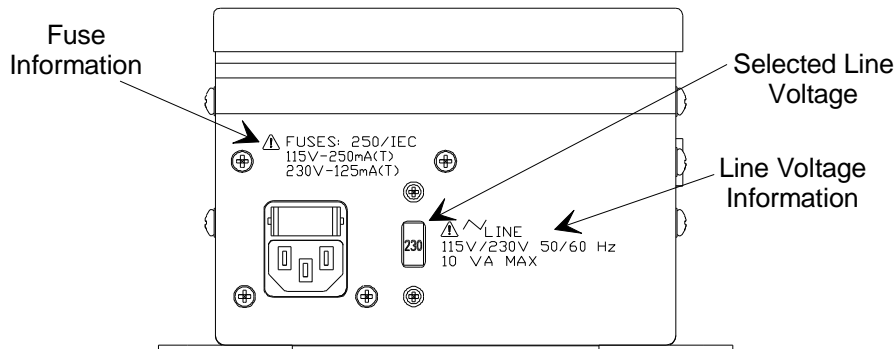

Figure 9: Fuse and Line Voltage Information

This page intentionally left blank.



## Chapter Four: Operation

### How To Zero the Type 220 Transducer

You must zero the transducer initially when you install it into your system and periodically thereafter.

**Note**



Make sure that the unit is fully stabilized before attempting to adjust the zero. Allow four (4) hours for the unit to warm up.

1. Pump down the pressure in the system to a pressure below the resolution of the 220 transducer.

Refer to Table 9 for the correct pump down pressure for the transducer full scale.

Maximum Pressure Reading for Zero Adjustment	
Full Scale Range (Torr)	Maximum Pressure for Zero Adjustment
1	$5 \times 10^{-5}$
10	$5 \times 10^{-4}$
100	$5 \times 10^{-3}$
1000	$5 \times 10^{-2}$
5000	$2.5 \times 10^{-1}$
10,000	$5 \times 10^{-1}$
15,000	$7.5 \times 10^{-1}$
20,000	1
25,000	1.25

Table 9: Maximum Pressure Reading for Zero Adjustment

2. Turn the zero potentiometer on the Amplifier board inside the 220 unit, shown in Figure 10, until the output is 0.0 Volts.

The zero adjustment may also be made at the front panel of an MKS supplied readout/power supply unit, if used.

**Note**

---

The coarse zero adjust is located on the amplifier board inside the 220 housing, shown in Figure 10. Do not adjust any other potentiometers on the Amplifier board.

---

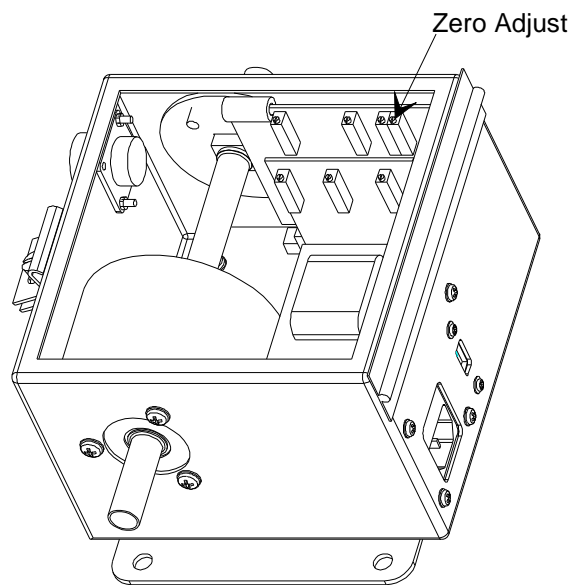

Figure 10: Zero Potentiometer on the Amplifier Board

## Chapter Five: Maintenance

### General Information

If the 220 pressure transducer fails to operate properly upon receipt, check for shipping damage, and check the cables for proper continuity. Any damage should be reported to the carrier and MKS Instruments immediately. If it is necessary to return the unit to MKS, obtain an RMA (Return Material Authorization) number from a MKS Service Center before shipping. Please refer to the inside back cover of this manual for a list of MKS Calibration and Service Centers.

---

**Warning**  **All returns to MKS Instruments must be free of harmful, corrosive, radioactive, or toxic materials.**

---

There are no user-repairable parts in the 220 transducer.

Periodically check for wear on the cables and inspect the enclosure for visible signs of damage.

### **How To Clean the Unit**

To clean the unit, wipe down the enclosure with a damp cloth.

### **How To Change the Fuse(s)**

1. Select the appropriate fuses.  
Refer to Table 6, page 26, for the fuse information.
2. Disconnect the power cord from the controller.

---

**Warning**  **Disconnect the power cord *before* proceeding to avoid an electrical shock.**

---

3. Insert a small, flat head screw driver under one side of the black fuse holder, then the other, to disengage the fuse holder.  
Refer to Figure 6, page 26, for the location of the fuse holder clip. The fuse holder will slide partially out of the instrument.
4. Carefully slide the fuse holder out and remove the fuse.
5. Insert the new fuse into the fuse holder.  
Be certain that the new fuse is the appropriate type for the line voltage selection.

6. Slide the fuse holder back into the Power Entry module.  
Be sure to snap the fuse holder completely into the instrument.
7. Connect the power cord.

## Appendix A: Product Specifications

### Common Specifications

Accuracy <sup>1</sup>	0.15% of Reading $\pm$ temperature coefficient
Ambient Operating Temperature	5° to 40° C (41° to 104° F)
Dimensions	7.5" H x 6" L (without fittings) x 6" D 190.5 mm x 152.4 mm (without fittings) x 152.4 mm
Fittings	½" tubulation Swagelok 8-VCR (only choice for units $\geq$ 5K Torr) 1.33 inch (33.7 mm) O.D. Conflat® NW16-KF
Full Scale Range (Torr)	1, 10, 100, 1000, 5000, 10000, 15000, 20000, 25000
Line Pressure (differential units only)	40 psig, maximum
Materials Exposed to Gases P <sub>X</sub> side P <sub>R</sub> side	Inconel® Inconel, ceramic, palladium, stainless steel, glass
Output Signal	0 to 10 VDC into $\geq$ 10K ohm load and 4 to 20 mA into $<$ 500 ohm load
Overpressure Limit	120% of Full Scale or 20 psi, whichever is greater
Resolution	0.01% Full Scale
Sensor Operating Temperature	45° C (113° F)
Temperature Coefficients Zero Span	0.005% F.S./° C 0.02% Reading/° C
Volume P <sub>X</sub> side P <sub>R</sub> side	7.00 cc 19.0 cc
Warm Up Time	4 hours

<sup>1</sup> Includes non-linearity, hysteresis, and non-repeatability.

## **AC Version Specifications**

CE Compliance Electromagnetic Compatibility <sup>2</sup> Low-Voltage Requirements Installation Category Pollution Degree Product Safety Requirements	EMC Directive 2004/108/EC Low-Voltage Directive 73/23/EC II, according to EN 61010-1 2, according to IEC 664 Product Safety Directive 92/59/EC
Fuse Ratings 115 V 230 V	250 mA (T) 125 mA (T)
Output Connector	MS3106A-14S-6P
Power Consumption Input Power Requirement	9.5 VA 115 or 230 VAC @ 50 - 60 Hz

## **DC Version Specifications**

CE Compliance Electromagnetic Compatibility <sup>2</sup>	EMC Directive 2004/108/EC
Input Power Required	22 to 30 VDC, 600 mA
Output Connector	MS3106A-18-1S

Due to continuing research and development activities, these product specifications are subject to change without notice.

---

<sup>2</sup> An overall metal braided shielded cable, properly grounded at both ends, is required during use.

## Appendix B: Model Code Explanation

### Model Code

The options of your 220 pressure transducer are identified in the model code when you order the unit.

The model code is identified as follows:

**220DXYYYYYZAB**

where:

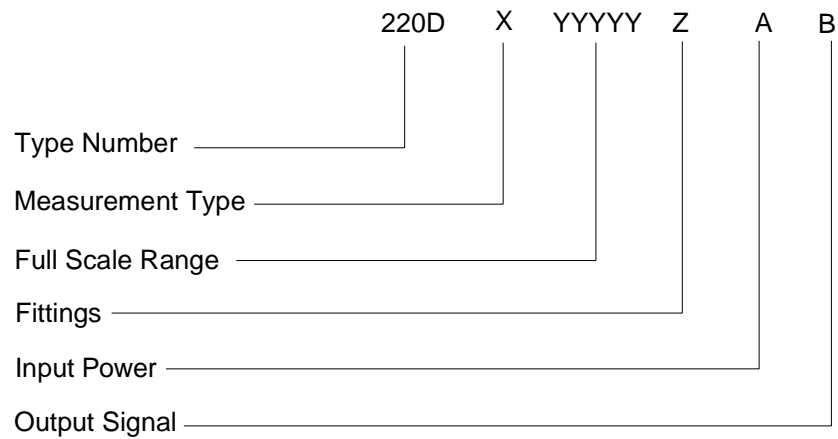

#### **Type Number (220D)**

This designates the model number of the instrument.

#### **Measurement Type (X)**

The measurement type, either absolute or differential, is represented by a one letter code.

#### **Measurement Type**

Absolute  
Differential

#### **Ordering Code**

A  
D

**Full Scale Range (YYYYY)**

The full scale range is indicated by a five digit code.

<b>Full Scale Range (Torr)</b>	<b>Ordering Code</b>
1	00001
10	00010
100	00100
1,000	01000
5,000	05000
10,000	10000
15,000	15000
20,000	20000
25,000	25000

**Fittings (Z)**

Four types of fittings are available, designated by a one letter code.

<b>Fittings</b>	<b>Ordering Code</b>
½" tube weld stub	A
Swagelok 8-VCR female	B
1.33 inch (33.7 mm) O.D. Conflat <sup>®</sup> , rotatable	C
NW16-KF (not available on ranges $\geq$ 5000 Torr)	D

**Input Power (A)**

The input power is designated by a single number code.

<b>Power</b>	<b>Ordering Code</b>
115/230 VAC	2
22 to 30 VDC	4

**Output Signal (B)**

The output signal is indicated by a single letter code.

<b>Output Signal</b>	<b>Ordering Code</b>
0 to 10 VDC and 4 to 20 mA	B



## Index

### A

Absolute transducer, 17  
AC powered, 17, 22, 26, 30, 38

### C

Cables, 20  
CE compliance, 17, 20, 31, 37  
Circuit, 29  
Connectors, 27, 28, 40  
Current output option, 30  
Customer support, 18

### D

DC powered, 17, 28  
Differential transducer, 17  
Dimensions, 23

### E

Electrical information, 40  
Enclosure, 17  
Environmental, 22

### F

Fittings, 37, 40  
Fuses, 26, 35

### G

Grounding, 20, 26

### I

Inlet port, 25  
Input power, 26, 28  
Installation Category, 22

Interface cables, 20

### L

Labels, 31  
Line voltage selector, 26

### M

Maintenance, 35  
Manual organization, 18  
Measurement type, 39  
Model code, 39  
Mounting, 25

### P

Pollution Degree, 22  
Power, 40  
Power supplies, 17, 22, 26, 28, 30

### R

Range, 40  
Returning the product, 18, 19, 35

### S

Sensor, 17, 29  
Specifications, 37–38

### T

Temperature, 22  
Transducer, 17, 29

### V

Vibration, 25

### Z

Zero, 33

