



MKS Baratron® Types 141A and 142A Vacuum/Pressure Switch

Instruction Manual

2 Technology Drive
Andover, MA, USA 01810

Main: 978.645.5500
USA: 800.227.8766
www.mksinst.com

112905-P1
Rev. F, 03/13
Instruction Manual



WARRANTY

for Type 141A/142A
Equipment

MKS Instruments, Inc. (MKS) warrants that the equipment described in the face of this warranty (the "equipment") manufactured by **MKS** shall be free from defects in materials and workmanship for a period of one year from date of shipment. For the period commencing with the date of shipment of this equipment and ending one year later, **MKS** will, at its option, either repair or replace any part which is defective in materials or workmanship without charge to the purchaser. The foregoing shall constitute the exclusive and sole remedy of the purchaser for any breach of **MKS** of this warranty.

The purchaser, before returning any equipment covered by this warranty, which is asserted to be defective by the purchaser, shall make specific written arrangements with respect to the responsibility for shipping the equipment and handling any other incidental charges with the **MKS** sales representative or distributor from which the equipment was purchased or, in the case of a direct purchase from **MKS**, with the **MKS** home office in Andover, Massachusetts, U.S.A.

This warranty does not apply to any equipment which has not been used in accordance with the specifications recommended by **MKS** for the proper and normal use of the equipment. **MKS** shall not be liable under any circumstances for consequential or incidental damages in connection with, or arising out of, the sale, performance, or use of the equipment covered by this warranty.

THIS WARRANTY IS IN LIEU OF ALL OTHER WARRANTIES BY **MKS**, EXPRESSED OR IMPLIED, INCLUDING THE IMPLIED WARRANTY OF MERCHANTABILITY, THE IMPLIED WARRANTY OF FITNESS FOR A PARTICULAR PURPOSE, AND ANY WARRANTY AGAINST INFRINGEMENT OF ANY PATENT.

5-96

112905-P1

SPECIAL NOTICE

This warranty is void if the product is installed using single or double metal ferrule compression type vacuum fittings, shown below. These fittings are commonly tightened incorrectly, causing damage to the pressure sensor.

Single Ferrule

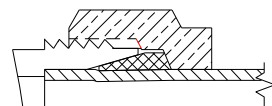

04/09

Double Ferrule

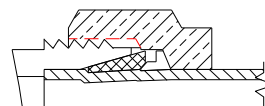

112905-P1

MKS Type 141A/142A Vacuum/Pressure Switch

Copyright © 2013 by MKS Instruments, Inc.

All rights reserved. No part of this work may be reproduced or transmitted in any form or by any means, electronic or mechanical, including photocopying and recording, or by any information storage or retrieval system, except as may be expressly permitted in writing by MKS Instruments, Inc.

Printed in the United States of America

Baratron® is a registered trademark of MKS Instruments, Inc., Andover, MA, USA.

Swagelok®, VCR®, and VCO® are registered trademarks of Swagelok Company, Solon, OH, USA.

Inconel® is a registered trademark of Inco Alloys International, Inc., Huntington, WV, USA.

Conflat® is a registered trademark of Varian Associates, Inc., Lexington, MA, USA.

Some Baratron® products may not be exported to many end user countries without both US and local government export licenses under ECCN 2B230.

Table of Contents

Pressure Transducer Safety Information	1
Symbols Used in This Instruction Manual.....	1
Symbols Found on the Unit	2
Safety Procedures and Precautions	3
Informations relatives à la sécurité pour le transducteur de pression	5
Symboles utilisés dans ce manuel d'utilisation	5
Symboles apparaissant sur l'unité	6
Mesures de sécurité et précautions	7
Sicherheitshinweise für den Druckmeßwertwandler	9
In dieser Betriebsanleitung vorkommende Symbole	9
Erklärung der am Gerät angebrachten Symbole	10
Sicherheitsvorschriften und Vorsichtsmaßnahmen.....	11
Medidas de seguridad del transductor de presión	13
Símbolos usados en este manual de instrucciones	13
Símbolos hallados en la unidad.....	14
Procedimientos y precauciones de seguridad	15
Chapter One: General Information	17
Introduction.....	17
How This Manual is Organized	18
Customer Support	18
Chapter Two: Installation	19
How To Unpack the Type 141A/142A Unit.....	19
Unpacking Checklist.....	19
Product Location and Requirements.....	20
Operating Environmental Requirements.....	20
Setup	21
Dimensions	21
Mounting.....	23
Electrical Information	24

Chapter Three: Overview	25
General Information	25
Labels	27
Serial Number Label	27
Chapter Four: Operation	29
General Information	29
How To Adjust the Relay Set Point	29
How To Activate Fail-Safe Operation	30
Chapter Five: Maintenance	31
General Information	31
How To Clean the Unit	31
Maintenance	31
Appendix A: Product Specifications	33
Electrical Specifications	33
Performance Specifications	33
Physical Specifications	34
Environmental Specifications	34
Appendix B: Model Code Explanation	35
Model Code	35
Index	37

List of Figures and Tables

Figures

Figure 1: Dimensions of a Type 141A Vacuum Pressure Switch.....	21
Figure 2: Dimensions of a Type 142A Vacuum Pressure Switch.....	22
Figure 3: Terminal Block Connections.....	24
Figure 4: Type 141A/142A Block Diagram	26
Figure 5: Serial Number Label	27

Tables

Table 1: Definition of Symbols Found on the Unit	2
Tableau 2: Définition des symboles apparaissant sur l'unité	6
Tabelle 3: Bedeutung der am Gerät angebrachten Symbole.....	10
Tabla 4: Definición de los símbolos hallados en la unidad.....	14

Pressure Transducer Safety Information

Symbols Used in This Instruction Manual

Definitions of WARNING, CAUTION, and NOTE messages used throughout the manual.

Warning  The **WARNING** sign denotes a hazard to personnel. It calls attention to a procedure, practice, condition, or the like, which, if not correctly performed or adhered to, could result in injury to personnel.

Caution  The **CAUTION** sign denotes a hazard to equipment. It calls attention to an operating procedure, practice, or the like, which, if not correctly performed or adhered to, could result in damage to or destruction of all or part of the product.

Note  The **NOTE** sign denotes important information. It calls attention to a procedure, practice, condition, or the like, which is essential to highlight.

Symbols Found on the Unit

The following table describes symbols that may be found on the unit.



















Definition of Symbols Found on the Unit			
  Off (Supply) IEC 417, No.5008	 Off (Supply) IEC 417, No.5008	  Protective earth (ground) IEC 417, No.5008	 Protective earth (ground) IEC 417, No.5008
  Direct current IEC 417, No.5032	 Direct current IEC 417, No.5032	  Alternating current IEC 417, No.5032	 Alternating current IEC 417, No.5032
 Both direct and alternating current IEC 417, No.5033-a	  Three phase alternating current IEC 617-2 No.020206	 Three phase alternating current IEC 617-2 No.020206	
 Caution, refer to accompanying documents ISO 3864, No.B.3.1	 Caution, risk of electric shock ISO 3864, No.B.3.6	 Caution, hot surface IEC 417, No.5041	

Table 1: Definition of Symbols Found on the Unit

Safety Procedures and Precautions

Observe the following general safety precautions during all phases of operation of this instrument. Failure to comply with these precautions or with specific warnings elsewhere in this manual violates safety standards of intended use of the instrument and may impair the protection provided by the equipment. MKS Instruments, Inc. assumes no liability for the customer's failure to comply with these requirements.

DO NOT SUBSTITUTE PARTS OR MODIFY INSTRUMENT

Do not install substitute parts or perform any unauthorized modification to the instrument. Return the instrument to an MKS Calibration and Service Center for service and repair to ensure that all safety features are maintained.

SERVICE BY QUALIFIED PERSONNEL ONLY

Operating personnel must not attempt component replacement and internal adjustments. Any service must be made by qualified service personnel only.

USE CAUTION WHEN OPERATING WITH HAZARDOUS MATERIALS

If hazardous materials are used, users must take responsibility to observe the proper safety precautions, completely purge the instrument when necessary, and ensure that the material used is compatible with the materials in this product, including any sealing materials.

PURGE THE INSTRUMENT

After installing the unit, or before removing it from a system, purge the unit completely with a clean, dry gas to eliminate all traces of the previously used flow material.

USE PROPER PROCEDURES WHEN PURGING

This instrument must be purged under a ventilation hood, and gloves must be worn for protection.

DO NOT OPERATE IN AN EXPLOSIVE ENVIRONMENT

To avoid explosion, do not operate this product in an explosive environment unless it has been specifically certified for such operation.

USE PROPER FITTINGS AND TIGHTENING PROCEDURES

All instrument fittings must be consistent with instrument specifications, and compatible with the intended use of the instrument. Assemble and tighten fittings according to manufacturer's directions.

CHECK FOR LEAK-TIGHT FITTINGS

Carefully check all vacuum component connections to ensure leak-tight installation.

OPERATE AT SAFE INLET PRESSURES

Never operate at pressures higher than the rated maximum pressure (refer to the product specifications for the maximum allowable pressure).

INSTALL A SUITABLE BURST DISC

When operating from a pressurized gas source, install a suitable burst disc in the vacuum system to prevent system explosion should the system pressure rise.

KEEP THE UNIT FREE OF CONTAMINANTS

Do not allow contaminants to enter the unit before or during use. Contamination such as dust, dirt, lint, glass chips, and metal chips may permanently damage the unit or contaminate the process.

ALLOW PROPER WARM UP TIME FOR TEMPERATURE-CONTROLLED UNITS

Temperature-controlled units will only meet specifications when sufficient time is allowed for the unit to meet, and stabilize at, the designed operating temperature. Do not zero or calibrate the unit until the warm up is complete.

Informations relatives à la sécurité pour le transducteur de pression

Symboles utilisés dans ce manuel d'utilisation

Définitions des indications AVERTISSEMENT, ATTENTION, et REMARQUE utilisées dans ce manuel.

Avertissement



L'indication **AVERTISSEMENT** signale un danger pour le personnel. Elle attire l'attention sur une procédure, une pratique, une condition, ou toute autre situation présentant un risque d'accident pour le personnel, en cas d'exécution incorrecte ou de non respect des consignes.

Attention



L'indication **ATTENTION** signale un danger pour l'appareil. Elle attire l'attention sur une procédure d'exploitation, une pratique, ou toute autre situation, présentant un risque d'endommagement ou de destruction d'une partie ou de la totalité de l'appareil, en cas d'exécution incorrecte ou de non respect des consignes.

Remarque



L'indication **REMARQUE** signale une information importante. Elle attire l'attention sur une procédure, une pratique, une condition, ou toute autre situation, présentant un intérêt particulier.

Symboles apparaissant sur l'unité

Le tableau suivant décrit les symboles pouvant apparaître sur l'unité.















Définition des symboles apparaissant sur l'unité			
			
Marche (sous tension) IEC 417, No.5007	Arrêt (hors tension) IEC 417, No.5008	Terre (masse) IEC 417, No.5017	Terre de protection (masse) IEC 417, No.5019
			
Masse IEC 417, No.5020	Equipotentialité IEC 417, No.5021	Courant continu IEC 417, No.5031	Courant alternatif IEC 417, No.5032
			
Courant continu et alternatif IEC 417, No.5033-a	Matériel de classe II IEC 417, No.5172-a	Courant alternatif triphasé IEC 617-2, No.020206	
			
Attention : se reporter à la documentation ISO 3864, No.B.3.1	Attention : risque de choc électrique ISO 3864, No.B.3.6	Attention : surface brûlante IEC 417, No.5041	

Tableau 2: Définition des symboles apparaissant sur l'unité

Mesures de sécurité et précautions

Prendre les précautions générales de sécurité suivantes pendant toutes les phases d'exploitation de cet appareil. Le non respect de ces précautions ou des avertissements contenus dans ce manuel constitue une violation des normes de sécurité relatives à l'utilisation de l'appareil et peut diminuer la protection fournie par l'appareil. MKS Instruments, Inc. n'assume aucune responsabilité concernant le non respect des consignes par les clients.

PAS DE SUBSTITUTION DE PIÈCES OU DE MODIFICATION DE L'APPAREIL

Ne pas installer des pièces de substitution ou effectuer des modifications non autorisées sur l'appareil. Renvoyer l'appareil à un centre de service et de calibrage MKS pour tout dépannage ou réparation afin de garantir le l'intégrité des dispositifs de sécurité.

DÉPANNAGE UNIQUEMENT PAR DU PERSONNEL QUALIFIÉ

Le personnel d'exploitation ne doit pas essayer de remplacer des composants ou de faire des réglages internes. Tout dépannage doit être uniquement effectué par du personnel qualifié.

PRÉCAUTION EN CAS D'UTILISATION AVEC DES PRODUITS DANGEREUX

Si des produits dangereux sont utilisés, l'utilisateur est responsable de la prise des mesures de précaution appropriées, de la purge complète de l'appareil quand cela est nécessaire, et de la garantie que les produits utilisés sont compatibles avec les composants de cet appareil, y compris les matériaux d'étanchéité.

PURGE DE L'APPAREIL

Après l'installation de l'unité, ou avant son enlèvement d'un système, purger l'unité complètement avec un gaz propre et sec afin d'éliminer toute trace du produit de flux utilisé précédemment.

UTILISATION DES PROCÉDURES APPROPRIÉES POUR LA PURGE

Cet appareil doit être purgé sous une hotte de ventilation, et il faut porter des gants de protection.

PAS D'EXPLOITATION DANS UN ENVIRONNEMENT EXPLOSIF

Pour éviter toute explosion, ne pas utiliser cet appareil dans un environnement explosif, sauf en cas d'homologation spécifique pour une telle exploitation.

UTILISATION D'ÉQUIPEMENTS APPROPRIÉS ET PROCÉDURES DE SERRAGE

Tous les équipements de l'appareil doivent être cohérents avec ses spécifications, et compatibles avec l'utilisation prévue de l'appareil. Assembler et serrer les équipements conformément aux directives du fabricant.

VÉRIFICATION DE L'ÉTANCHÉITÉ DES CONNEXIONS

Vérifier attentivement toutes les connexions des composants pour le vide afin de garantir l'étanchéité de l'installation.

EXPLOITATION AVEC DES PRESSIONS D'ENTRÉE NON DANGEREUSES

Ne jamais utiliser des pressions supérieures à la pression nominale maximum (se reporter aux spécifications de l'unité pour la pression maximum admissible).

INSTALLATION D'UN DISQUE D'ÉCHAPPEMENT ADAPTÉ

En cas d'exploitation avec une source de gaz pressurisé, installer un disque d'échappement adapté dans le système à vide, afin d'éviter une explosion du système en cas d'augmentation de la pression.

MAINTIEN DE L'UNITÉ À L'ABRI DES CONTAMINATIONS

Ne pas laisser des produits contaminants pénétrer dans l'unité avant ou pendant l'utilisation. Des produits contaminants tels que des poussières et des fragments de tissu, de glace et de métal peuvent endommager l'unité d'une manière permanente ou contaminer le processus.

RESPECT DU TEMPS D'ÉCHAUFFEMENT APPROPRIÉ POUR LES UNITÉS À TEMPÉRATURE CONTRÔLÉE

Les unités à température contrôlée atteignent leurs spécifications uniquement quand on leur laisse un temps suffisant pour atteindre d'une manière stable la température d'exploitation. Ne pas remettre à zéro ou calibrer l'unité tant que l'échauffement n'est pas terminé.

Sicherheitshinweise für den Druckmeßwertwandler

In dieser Betriebsanleitung vorkommende Symbole

Bedeutung der mit WARNUNG!, VORSICHT! und HINWEIS gekennzeichneten Absätze in dieser Betriebsanleitung.

Warnung!



Das Symbol **WARNUNG!** weist auf eine Gefahr für das Bedienpersonal hin. Es macht auf einen Arbeitsablauf, eine Arbeitsweise, einen Zustand oder eine sonstige Gegebenheit aufmerksam, deren unsachgemäße Ausführung bzw. ungenügende Berücksichtigung zu Verletzungen führen kann.

Vorsicht!



Das Symbol **VORSICHT!** weist auf eine Gefahr für das Gerät hin. Es macht auf einen Bedienungsablauf, eine Arbeitsweise oder eine sonstige Gegebenheit aufmerksam, deren unsachgemäße Ausführung bzw. ungenügende Berücksichtigung zu einer Beschädigung oder Zerstörung des Gerätes oder von Teilen des Gerätes führen kann.

Hinweis



Das Symbol **HINWEIS** macht auf wichtige Informationen bezüglich eines Arbeitsablaufs, einer Arbeitsweise, eines Zustands oder einer sonstige Gegebenheit aufmerksam.

Erklärung der am Gerät angebrachten Symbole

Nachstehender Tabelle sind die Bedeutungen der Symbole zu entnehmen, die am Gerät angebracht sein können.















Bedeutung der am Gerät angebrachten Symbole			
			
Ein (Netz) IEC 417, No.5007	Aus (Netz) IEC 417, No.5008	Erde IEC 417, No.5017	Schutzerdung IEC 417, No.5019
			
Rahmen, Chassis IEC 417, No.5020	Aquipotential- anschluß IEC 417, No.5021	Gleichstrom IEC 417, No.5031	Wechselstrom IEC 417, No.5032
			
Gleichstrom und Wechselstrom IEC 417, No.5033-a	Geräteklasse II IEC 417, No.5172-a	Drehstrom IEC 617-2, No.020206	
			
Vorsicht! Bitte Begleitdokumente lesen! ISO 3864, No.B.3.1	Vorsicht! Stromschlaggefahr! ISO 3864, No.B.3.6	Vorsicht! Heiße Oberfläche! IEC 417, No.5041	

Tabelle 3: Bedeutung der am Gerät angebrachten Symbole

Sicherheitsvorschriften und Vorsichtsmaßnahmen

Folgende allgemeine Sicherheitsvorschriften sind während allen Betriebsphasen dieses Instruments zu befolgen. Eine Mißachtung der Sicherheitsvorschriften und sonstiger Warnhinweise in dieser Betriebsanleitung verletzt die für dieses Instrument und seine Bedienung geltenden Sicherheitsstandards, und kann die Schutzvorrichtungen an diesem Gerät wirkungslos machen. MKS Instruments, Inc. haftet nicht für Mißachtung dieser Sicherheitsvorschriften seitens des Kunden.

Niemals Teile austauschen oder Änderungen am Gerät vornehmen!

Ersetzen Sie keine Teile mit baugleichen oder ähnlichen Teilen, und nehmen Sie keine eigenmächtigen Änderungen am Gerät vor. Schicken Sie das Instrument zwecks Wartung und Reparatur an den MKS-Kalibrierungs- und -Kundendienst ein. Nur so wird sichergestellt, daß alle Schutzvorrichtungen voll funktionsfähig bleiben.

Wartung nur durch qualifizierte Fachleute!

Das Auswechseln von Komponenten und das Vornehmen von internen Einstellungen darf nur von qualifizierten Fachleuten durchgeführt werden, niemals vom Bedienpersonal.

Vorsicht beim Arbeiten mit gefährlichen Stoffen!

Wenn gefährliche Stoffe verwendet werden, muß der Bediener die entsprechenden Sicherheitsvorschriften genauestens einhalten, das Instrument, falls erforderlich, vollständig ausblasen, sowie sicherstellen, daß der Gefahrstoff die am Gerät verwendeten Materialien, insbesondere Dichtungen, nicht angreift.

Ausblasen des Instrumentes

Nach dem Installieren oder vor dem Ausbau aus einem System muß das Instrument unter Einsatz eines reinen Trockengases vollständig ausgeblasen werden, um alle Rückstände des Vorgängermediums zu entfernen.

Anweisungen zum Ausblasen des Instrumentes

Das Instrument darf nur unter einer Ablufthaube ausgeblasen werden. Schutzhandschuhe sind zu tragen.

Gerät nicht zusammen mit explosiven Stoffen, Gasen oder Dämpfen benutzen!

Um der Gefahr einer Explosion vorzubeugen, darf dieses Gerät niemals zusammen mit (oder in der Nähe von) explosiven Stoffen aller Art eingesetzt werden, sofern es nicht ausdrücklich für diesen Zweck zugelassen ist.

Anweisungen zum Installieren der Armaturen

Alle Anschlußstücke und Armaturenteile müssen mit der Gerätespezifikation übereinstimmen, und mit dem geplanten Einsatz des Instrumentes kompatibel sein. Der Einbau, insbesondere das Anziehen und Abdichten, muß gemäß den Anweisungen des Herstellers vorgenommen werden.

Verbindungen auf Undichtigkeiten prüfen!

Überprüfen Sie sorgfältig alle Verbindungen der Vakuumkomponenten auf undichte Stellen.

Gerät nur unter zulässigen Anschlußdrücken betreiben!

Betreiben Sie das Instrument niemals unter Drücken, die den maximal zulässigen Druck (siehe Produktspezifikationen) übersteigen.

Geeignete Berstscheibe installieren!

Wenn mit einer unter Druck stehenden Gasquelle gearbeitet wird, sollte eine geeignete Berstscheibe in das Vakuumsystem installiert werden, um eine Explosionsgefahr aufgrund von steigendem Systemdruck zu vermeiden.

Verunreinigungen im Gerät vermeiden!

Stellen Sie sicher, daß Verunreinigungen jeglicher Art weder vor dem Einsatz noch während des Betriebs in das Instrumenteninnere gelangen können. Staub- und Schmutzpartikel, Glassplitter oder Metallspäne können das Gerät dauerhaft beschädigen oder Prozeß und Meßwerte verfälschen.

Bei Geräten mit Temperaturkontrolle korrekte Anwärmzeit einhalten!

Temperaturkontrollierte Instrumente arbeiten nur dann gemäß ihrer Spezifikation, wenn genügend Zeit zum Erreichen und Stabilisieren der Betriebstemperatur eingeräumt wird. Kalibrierungen und Nulleinstellungen sollten daher nur nach Abschluß des Anwärmvorgangs durchgeführt werden.

Medidas de seguridad del transductor de presión

Símbolos usados en este manual de instrucciones

Definiciones de los mensajes de advertencia, precaución y de las notas usados en el manual.

Advertencia

El símbolo de advertencia indica la posibilidad de que se produzcan daños personales. Pone de relieve un procedimiento, práctica, estado, etc. que en caso de no realizarse u observarse correctamente puede causar daños personales.

Precaución

El símbolo de precaución indica la posibilidad de producir daños al equipo. Pone de relieve un procedimiento operativo, práctica, estado, etc. que en caso de no realizarse u observarse correctamente puede causar daños o la destrucción total o parcial del equipo.

Nota

El símbolo de notas indica información de importancia. Este símbolo pone de relieve un procedimiento, práctica o condición cuyo conocimiento es esencial destacar.

Símbolos hallados en la unidad

La tabla siguiente contiene los símbolos que puede hallar en la unidad.















Definición de los símbolos hallados en la unidad			
			
Encendido (alimentación eléctrica) IEC 417, N° 5007	Apagado (alimentación eléctrica) IEC 417, N° 5008	Puesta a tierra IEC 417, N° 5017	Protección a tierra IEC 417, N° 5019
			
Caja o chasis IEC 417, N° 5020	Equipotencialidad IEC 417, N° 5021	Corriente continua IEC 417, N° 5031	Corriente alterna IEC 417, N° 5032
			
Corriente continua y alterna IEC 417, N° 5033-a	Equipo de clase II IEC 417, N° 5172-a	Corriente alterna trifásica IEC 617-2, N° 020206	
			
Precaución. Consulte los documentos adjuntos ISO 3864, N° B.3.1	Precaución. Riesgo de descarga eléctrica ISO 3864, N° B.3.6	Precaución. Superficie caliente IEC 417, N° 5041	

Tabla 4: Definición de los símbolos hallados en la unidad

Procedimientos y precauciones de seguridad

Las precauciones generales de seguridad descritas a continuación deben observarse durante todas las etapas de funcionamiento del instrumento. La falta de cumplimiento de dichas precauciones o de las advertencias específicas a las que se hace referencia en el manual, constituye una violación de las normas de seguridad establecidas para el uso previsto del instrumento y podría anular la protección proporcionada por el equipo. Si el cliente no cumple dichas precauciones y advertencias, MKS Instruments, Inc. no asume responsabilidad legal alguna.

NO UTILICE PIEZAS NO ORIGINALES O MODIFIQUE EL INSTRUMENTO

No instale piezas que no sean originales ni modifique el instrumento sin autorización. Para asegurar el correcto funcionamiento de todos los dispositivos de seguridad, envíe el instrumento al Centro de servicio y calibración de MKS toda vez que sea necesario repararlo o efectuar tareas de mantenimiento.

LAS REPARACIONES DEBEN SER EFECTUADAS ÚNICAMENTE POR TÉCNICOS AUTORIZADOS

Los operarios no deben intentar reemplazar los componentes o realizar tareas de ajuste en el interior del instrumento. Las tareas de mantenimiento o reparación deben ser realizadas únicamente por personal autorizado.

TENGA CUIDADO CUANDO TRABAJE CON MATERIALES TÓXICOS

Cuando se utilicen materiales tóxicos, es responsabilidad de los operarios tomar las medidas de seguridad correspondientes, purgar totalmente el instrumento cuando sea necesario y comprobar que el material utilizado sea compatible con los materiales del instrumento e inclusive, con todos los materiales de sellado.

PURGUE EL INSTRUMENTO

Una vez instalada la unidad o antes de retirarla del sistema, purgue completamente la unidad con gas limpio y seco para eliminar todo resto de la sustancia líquida empleada anteriormente.

USE PROCEDIMIENTOS ADECUADOS PARA REALIZAR LA PURGA

El instrumento debe purgarse debajo de una campana de ventilación y deben utilizarse guantes protectores.

NO HAGA FUNCIONAR EL INSTRUMENTO EN AMBIENTES CON RIESGO DE EXPLOSIÓN

Para evitar que se produzcan explosiones, no haga funcionar este instrumento en un ambiente con riesgo de explosiones, excepto cuando el mismo haya sido certificado específicamente para tal uso.

USE ACCESORIOS ADECUADOS Y REALICE CORRECTAMENTE LOS PROCEDIMIENTOS DE AJUSTE

Todos los accesorios del instrumento deben cumplir las especificaciones del mismo y ser compatibles con el uso que se debe dar al instrumento. Arme y ajuste los accesorios de acuerdo con las instrucciones del fabricante.

COMPRUEBE QUE LAS CONEXIONES SEAN A PRUEBA DE FUGAS

Inspeccione cuidadosamente las conexiones de los componentes de vacío para comprobar que hayan sido instalados a prueba de fugas.

HAGA FUNCIONAR EL INSTRUMENTO CON PRESIONES DE ENTRADA SEGURAS

No haga funcionar nunca el instrumento con presiones superiores a la máxima presión nominal (en las especificaciones del instrumento hallará la presión máxima permitida).

INSTALE UNA CÁPSULA DE SEGURIDAD ADECUADA

Cuando el instrumento funcione con una fuente de gas presurizado, instale una cápsula de seguridad adecuada en el sistema de vacío para evitar que se produzcan explosiones cuando suba la presión del sistema.

MANTENGA LA UNIDAD LIBRE DE CONTAMINANTES

No permita el ingreso de contaminantes en la unidad antes o durante su uso. Los productos contaminantes tales como polvo, suciedad, pelusa, lascas de vidrio o virutas de metal pueden dañar irreparablemente la unidad o contaminar el proceso.

CALIENTE ADECUADAMENTE LAS UNIDADES CONTROLADAS POR MEDIO DE TEMPERATURA

Las unidades controladas por medio de temperatura funcionarán de acuerdo con las especificaciones sólo cuando se las caliente durante el tiempo suficiente para permitir que lleguen y se estabilicen a la temperatura de operación indicada. No calibre la unidad y no la ponga en cero hasta que finalice el procedimiento de calentamiento.

Chapter One: General Information

Introduction

Note

Some Baratron® products may not be exported to many end user countries without both US and local government export licenses under ECCN 2B230.

The MKS Type 141A/142A Vacuum Pressure Switches are based on the well-known MKS Baratron® capacitance manometer and are dedicated to operating an internal relay, which provides two contact closures or openings as outputs (DPDT). The 141A/142A units offer fast, accurate, and reliable protection for vacuum equipment and processes. Designed for applications where a DC signal output is not required, the relay outputs are readily interfaced with alarms, valve actuators, computers, process controllers, or other protection devices. The 142A switch operates at an internal temperature of 100°C to help minimize effluent contamination build-up.

The 141A/142A switches combine the proven MKS high-accuracy sensor with full scale ranges from 1 Torr to 25,000 Torr (0.13 to 3333 kPa) and resolution of 0.01 % of full scale, together with signal conditioning and relay output circuitry within a single enclosure. The vacuum pressure switch senses the deflection of a diaphragm due to applied pressure, providing a switched output when pressure exceeds the chosen trip point. An LED provides visual "Above Set Point" indication, and facilitates adjustment of the trip point. The dual electrode design is an all metal, all welded design, thus exposing only corrosion-resistant Inconel® to the process gases. This design ensures fast response to pressure transients independent of gas composition.

The 142A switch also contains circuitry and thermal housing which controls the sensor temperature at 100°C, thereby minimizing effluent build-up and effects of ambient or process temperature variations typically encountered in process environments.

The vacuum pressure switches may be wired internally for Fail-Safe operation. In this mode, the output relay will be energized when the pressure is below the trip point instead of above. Failure of key components such as the relay (open coil) or loss of power supply voltage will then cause a high pressure (alarm) condition, in addition to any over-pressure faults.

How This Manual is Organized

This manual is designed to provide instructions on how to set up, install, and operate a Type 141A/142A unit.

Before installing your Type 141A/142A unit in a system and/or operating it, carefully read and familiarize yourself with all precautionary notes in the *Safety Messages and Procedures* section at the front of this manual. In addition, observe and obey all WARNING and CAUTION notes provided throughout the manual.

Chapter One, *General Information*, (this chapter) introduces the product and describes the organization of the manual.

Chapter Two, *Installation*, explains the environmental requirements and describes how to mount the instrument in your system.

Chapter Three, *Overview*, gives a brief description of the instrument and its functionality.

Chapter Four, *Operation*, describes how to use the instrument and explains all the functions and features.

Chapter Five, *Maintenance*, lists any maintenance required to keep the instrument in good working condition.

Appendix A, *Product Specifications*, lists the specifications of the instrument.

Appendix B, *Model Code Explanation*, describes the model code used to order the instrument.

Customer Support

Standard maintenance and repair services are available at all of our regional MKS Calibration and Service Centers, listed on the back cover. In addition, MKS accepts the instruments of other manufacturers for recalibration using the Primary and Transfer Standard calibration equipment located at all of our regional service centers. Should any difficulties arise in the use of your Type 141A/142A instrument, or to obtain information about companion products MKS offers, contact any authorized MKS Calibration and Service Center. If it is necessary to return the instrument to MKS, please obtain an RMA (Return Material Authorization) number from the MKS Calibration and Service Center before shipping. The RMA Number expedites handling and ensures proper servicing of your instrument.

Please refer to the inside of the back cover of this manual for a list of MKS Calibration and Service Centers.

Warning



All returns to MKS Instruments must be free of harmful, corrosive, radioactive, or toxic materials.

Chapter Two: Installation

How To Unpack the Type 141A/142A Unit

MKS has carefully packed the 141A/142A unit so that it will reach you in perfect operating order. Upon receiving the unit, however, you should check for defects, cracks, broken connectors, etc., to be certain that damage has not occurred during shipment.

Note

Do *not* discard any packing materials until you have completed your inspection and are sure the unit arrived safely.

If you find any damage, notify your carrier and MKS immediately. If it is necessary to return the unit to MKS, obtain an ERA Number (Equipment Return Authorization Number) from the MKS Service Center before shipping. Please refer to the inside of the back cover of this manual for a list of MKS Calibration and Service Centers.

Unpacking Checklist

Standard Equipment:

- Type 141A/142A Unit
- Type 141A/142A Instruction Manual (this book)

Product Location and Requirements

Operating Environmental Requirements

- Ambient operating temperature:
Type 141A: 0° C to 50° C (32° F to 122° F)
Type 142A: 20° C to 70° C (68° F to 158° F); temperature controlled at 100° C (212° F)
- Input power requirements:
Type 141A: +20 to +30 VDC (60 mA @ 24 VDC)
Type 142A: +20 to +30 VDC A 1.2 Amps. max. (875 mA @ 24 VDC)

Setup

Dimensions

Note



All dimensions are listed in inches with millimeters referenced in parentheses.

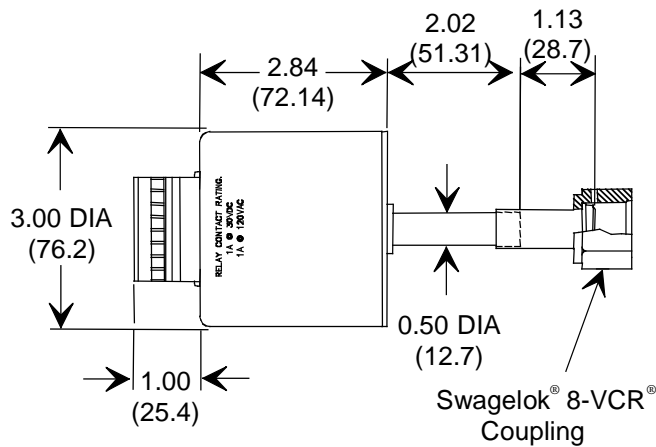

5K MM Through 25K MM

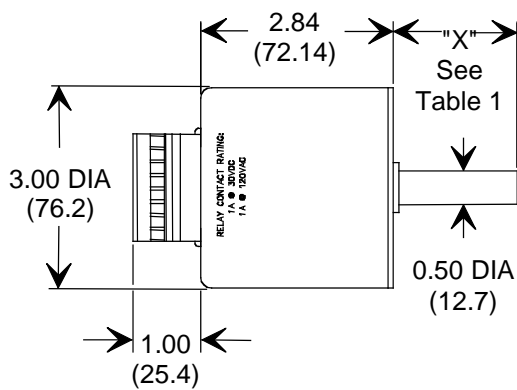

1 MM Through 1K MM

TABLE 1	
RANGE	DIM "X"
1 mm, 2 mm	1.82 (46.23)
10, 100, 1K mm	2.02 (51.31)

Figure 1: Dimensions of a Type 141A Vacuum Pressure Switch

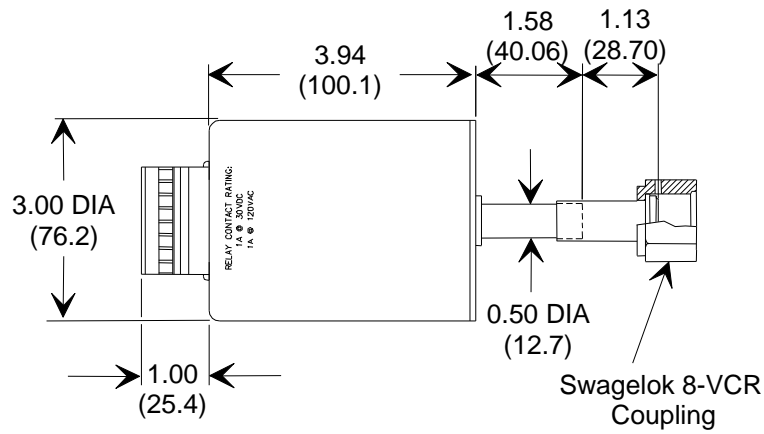

5K MM Through 25K MM

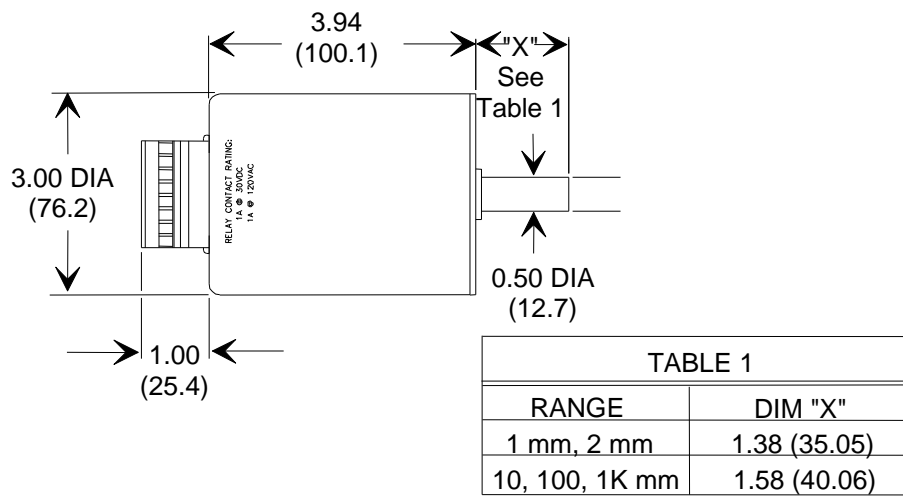

1 MM Through 1K MM

Figure 2: Dimensions of a Type 142A Vacuum Pressure Switch

Mounting

Before mounting the device, refer to *How To Activate Fail-Safe Operation*, page 30, and decide which mode of operation your application requires.

The unit is designed to be mounted in any orientation. It is recommended, however, that the unit be mounted with the inlet port vertically downward as any foreign matter entering the pressure port will fall away from the diaphragm, thereby not affecting the measurement. It is important that the unit be kept free of vibration, as the diaphragm when not subject to gas damping at low pressure, may become susceptible to resonance. The 1 Torr FS units are the most sensitive and any vibration that exists should be isolated from the unit by the use of sponge rubber pads and a bellows coupling.

Electrical Information

The 141A/142A switches require an external power supply capable of supplying +20 to +30 VDC at 60 mA for the 141A switch and 1.2 Amps maximum for the 142A switch in order to power the internal circuitry and ensure that the 142A switch is properly temperature regulated at 100° C over the wide range of supply voltages.

Figure 3 shows the terminal block connections for the 141A/142A switches.

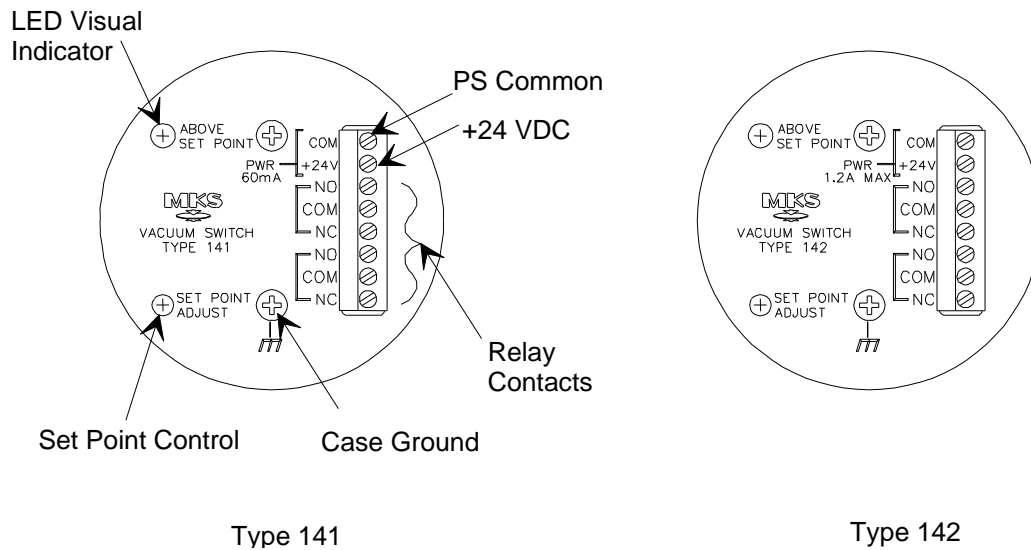

Figure 3: Terminal Block Connections

Shielded cable assemblies are recommended if the environment contains high EMI/RFI noise. The Normally Open (NO), Normally Closed (NC), and Common (COM) contacts are brought out for both sets of contacts. The relay is a DPDT (2 Form C) relay with contacts rated up to 1 Amp at 12 to 28 VDC or 1 Amp at 9 to 120 VAC resistive. The NO contacts are open when the unit is off and when the pressure is below the set point. When pressure is above the set point the relay will be energized and the NO contacts will close. Fail-Safe operation provides for the relay to be energized when pressure is below the set point (refer to *How To Activate Fail-Safe Operation*, page 30, for more information).

Chapter Three: Overview

General Information

The variable capacitance sensor consists of rigidly attached capacitive electrodes located on the back or reference side of a metal diaphragm. The reference side is permanently evacuated and sealed thus making the pressure measurement totally independent of the gas type or composition. When pressure is applied to the diaphragm, its deflection produces a change in the distance between the electrodes and the diaphragm and a resultant capacitance change.

The center electrode increases its capacity at a greater rate than does the outer concentric electrode. This imbalance of capacities caused by pressure is converted to a small DC Voltage in the first stage diode bridge (refer to Figure 4, page 26). The bridge is excited by a constant frequency oscillator. The resultant signal is zeroed, amplified and compared to the trip point voltage as set by the Set Point Adjust potentiometer. If the pressure signal is above the trip point voltage the comparator turns on the relay drivers and the LED to indicate an over-pressure condition. To eliminate relay chatter and ensure proper switching the circuit contains a small amount of hysteresis which results in trip point accuracy of $\pm 0.5\%$ of sensor range. In the Normal mode of operation the normally open relay contacts will close and the normally closed contacts will open. In the Fail-Safe mode of operation the comparator will turn the relay drivers on when the pressure signal is below the trip point voltage. When the pressure signal is above the trip point voltage the comparator turns the relay drivers off. The normally open contacts will open and the normally closed contacts will close.

The 142A sensor and bridge electronics are temperature controlled at 100° C. The thermal enclosure will reduce the effects of ambient temperature changes providing superior temperature stability over the 141A unit and minimizing effluent contamination build-up on the sensor.

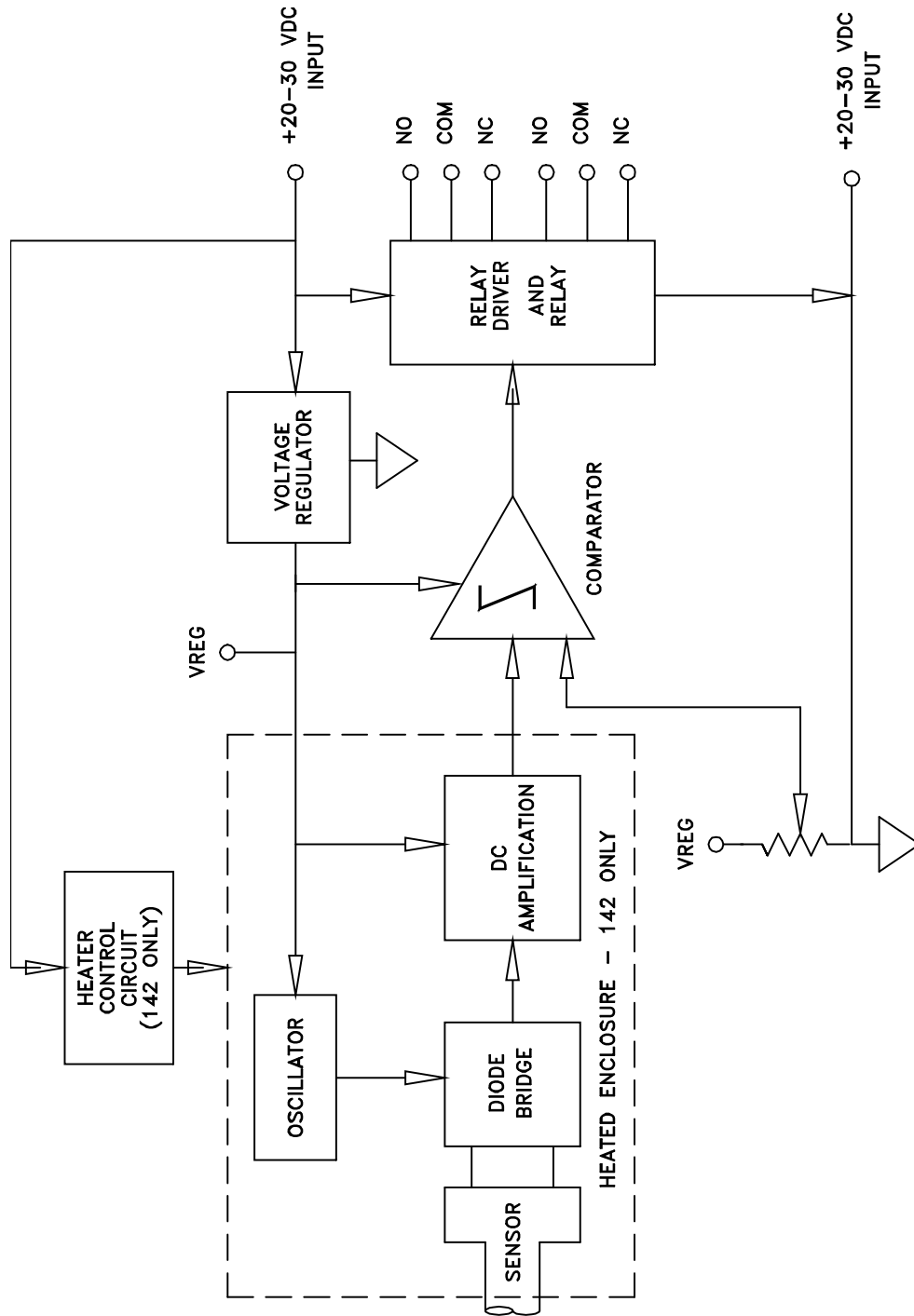

Figure 4: Type 141A/142A Block Diagram

Labels

Serial Number Label

The serial number label lists the serial number and the model number of the unit.



Figure 5: Serial Number Label

Note

If your 141A/142A unit was ordered for fail-safe operation, there will be a special number, SP111-90, marked on the serial number label.

This page intentionally left blank.

Chapter Four: Operation

General Information

The vacuum pressure switch should first be inspected and installed as outlined in *Chapter Two: Installation*, page 19. After the unit has been installed and power applied, a minimum of 15 minutes for the 141A switch and 4 hours for the 142A switch should be allowed for the unit to stabilize. In the case of the 142A switch, four hours is necessary to allow the heater in the transducer package to thermally stabilize the sensor at control temperature. While waiting for the sensor to reach stable thermal equilibrium, the appropriate vacuum pumps in the processing system could be engaged to facilitate calibrating the set point (relay trip point) of the switch. The vacuum pressure switch is calibrated to specifications at the factory and every effort is made to ensure that shipments arrive at the users location free of defects or need for further calibration other than set point adjustment. It is advised that users do not attempt adjustments other than the trip point adjust.

Caution



Components inside the 141A/142A instrument are susceptible to electrostatic discharge. To avoid damage to the unit, service personnel should handle all components as ESD sensitive devices and work on an appropriate ESD workstation.

How To Adjust the Relay Set Point

The set point adjustment potentiometer is accessed through a hole on the top of the 141A/142A enclosure. Increasing pressure, going above a given set point, will cause the relay contacts to change state and light the visual indicator. The LED should always remain dark when the monitored pressure is below the trip point. To adjust the trip point apply the required trip point pressure to the pressure switch. Adjust the potentiometer to find the trip point as indicated by the LED. A clockwise rotation of the set point adjust will raise the pressure level required to trip the relay contacts. Adjust the potentiometer slowly about the trip point making sure that the LED glows when the pressure is above the trip point. Set the final pressure trip level as required.

How To Activate Fail-Safe Operation

The pressure switch may be jumpered internally for Fail-Safe operation. In this mode the relay will be energized below the trip point instead of above. The normally open (NO) contacts will be closed and normally closed (NC) contacts will be open at pressures below the trip point. Failure of key components such as the relay coil or loss of power supply voltage will then cause an alarm condition, as well as any over-pressure faults.

Note

If the 141A/142A unit was ordered with fail-safe operation, there will be a special number, SP111-90, marked on the serial number label and the following instructions are not necessary.

To jumper the 141A/142A unit for fail-safe operation:

1. Remove the cover to expose the top printed circuit board.
2. For Normal operation jumper J3-1 to J3-2 and J3-3 to J3-4.
3. For fail-safe operation jumper J3-2 to J3-4 and J3-1 to J3-3.
4. Re-attach the cover to the unit.

Caution

Only change the operation mode jumper with power disconnected. When using the 142A unit which is heated to 100° C, ensure that the unit has had sufficient time to cool down (approximately ½ hour) before removing the cover. *Never operate the pressure switch with the cover removed.*

Chapter Five: Maintenance

General Information

Periodically check for wear on the cables and inspect the enclosure for visible signs of damage.

How To Clean the Unit

Periodically wipe down the unit with a damp cloth.

Maintenance

Should any difficulty be encountered in the use of this instrument, it is recommended that you contact any authorized MKS Calibration or Service Center, listed on the back cover, for repair instructions.

Note



MKS recommends that you do not attempt to repair the transducer signal conditioner electronics since replacement or movement of many PC board components may require complete recalibration of the unit.

This page intentionally left blank.

Appendix A: Product Specifications

Electrical Specifications

Power Required Type 141A Type 142A	+20 to +30 VDC (60 mA @ 24 VDC) +20 to +30 VDC A 1.2 Amps. max. (875 mA @ 24 VDC)
Electromagnetic Compatibility	Fully compliant to CE Directive 2004/108/EC ¹
Outputs Electromechanical Relay	DPDT (isolated) contacts rated up to 2 Amp @ 30 VDC. Relay is energized when pressure is above set point. Fail-Safe operation provides for the relay to be energized when pressure is below set point.

Performance Specifications

Accuracy	± 0.5% of Range (± temperature coefficients)
Full Scale Ranges	1, 2, 10, 100, 1000, 5000, 10000, 15000, 20000, 25000 Torr
Media Compatibility	Any gas compatible with Inconel and 300-series stainless steel
Overpressure	125% of FS or 35 psia, whichever is greater 1 and 2 Torr units have max. overpressure of 25 psia
Temperature Coefficients Zero: Type 141A Type 142A Span: Type 141A Type 142A	± 0.04% of FS/° C max. (400 ppm/° C) ± 0.015% of FS/° C max. (150 ppm/° C) ± 0.06% of FS/° C max. (600 ppm/° C) ± 0.03% of FS/° C max. (300 ppm/° C)
Time Response	< 20 msec
Trip Point Range	0.2 to 100% of Full Scale (units shipped with set point at 50% of FS unless otherwise specified)
Type of Measurement	Absolute
Volume 1 to 1000 Torr 5000 to 25000 Torr	7.0 cc 8.5 cc

Physical Specifications

Fittings Standard Optional	$\frac{1}{2}$ " (12.7 mm) tubulation Swagelok 8 female VCR, 1.33 inch (33.8 mm) O.D. Conflat [®] , NW-16-KF, Swagelok female 8-VCO [®] 5,000 to 25,000 Torr units are supplied with $\frac{1}{2}$ " diameter ports terminated with 8-VCR fittings
Mechanical Outline Type 141A Type 142A	Refer to Figure 1, page 21. Refer to Figure 2, page 22.

Environmental Specifications

Ambient Operating Temperature Range Type 141A Type 142A	0° to 50° C (32° to 122° F) 20° to 70° C (68° to 158° F); temperature controlled at 100° C (212° F)
Storage Humidity	0 to 95%, non-condensing

¹For CE compliance, an overall metal-braided shielded cable, properly grounded at both ends, must be used.

Due to continuing research and development activities, these product specifications are subject to change without notice.

Appendix B: Model Code Explanation

Model Code

The options of your unit are identified in the model code. The model code is identified as follows:

Type 14XA-XXXXXYZ

where:

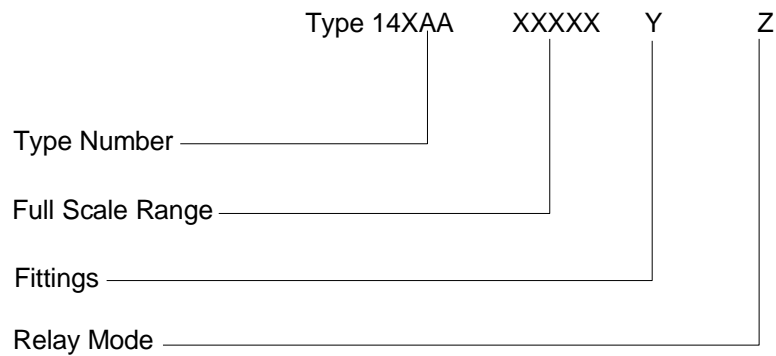

Type Number (14XA)

This designates the model number of the instrument; either 141A or 142A.

Full Scale Range (XXXXX)

The full scale range is indicated by a five-digit code.

Full Scale Range	Ordering Code
1	00001
2	00002
10	00010
100	00100
1000	01000
5000	05000
10000	10000
15000	15000
20000	20000
25000	25000

Fittings (Y)

The choice of fittings is designated by a single letter code.

Fittings	Ordering Code
½" Diameter Tubulation (10, 100 and 1000 Torr units only)	A
Swagelok® 8-VCR® Female	B
1.33 inch (33.8 mm) O.D. Conflat®, rotatable	C
NW-16-KF	D
Swagelok 8-VCO® Female	E

Relay Mode (Z)

This entry designates the operation of the relays, either standard or fail-safe.

Relay Mode	Ordering Code
Energize with pressure increasing (standard operation)	A
Energize with pressure decreasing (fail-safe operation)	B

Index

A

Accuracy, 33

C

Cleaning, 31

Customer support, 18

D

Dimensions, 21–22

E

Electrical, 24

F

Fail-safe, 17, 24, 30, 36

Fittings, 34, 36

Full scale range, 36

I

Informations relatives à la sécurité pour le transducteur de pression, 5

Input power, 20, 24, 33

Installation

 checklist, 19

M

Maintenance, 31

Manual organization, 18

Medidas de seguridad del transductor de presión, 13

Model code, 35

Mounting, 23

O

Operation

 fail-safe operation, 30

 set point adjustment, 29

P

Pressure Transducer Safety Information, 1

R

Relays, 17, 24, 33, 36

Returning the product, 18, 19

S

Sensor, 25

Serial number label, 27

Set point, 17

Set point adjustment, 29

Setup

 interconnections, 24

 mounting instructions, 23

Sicherheitshinweise für den Druckmeßwertwandler, 9

Specifications, 33–34

T

Temperature, 20, 34

Temperature controlled, 17, 20

Trip point, 17, 29, 33

Trip points, 36

W

Warm up, 29

