

Leak Detection

Vacuum Measurement
and Components

In Situ Analysis



LEYBOLD INFICON
The Instrumental Difference™

TH 10.211/ 8.02



UL 200

Helium Leak Detector

Cat. No.

140 00	141 00	142 00
140 01	141 01	142 10
140 10	141 10	142 11
140 11	141 11	

for software version V 2.6

Technical Handbook

Leybold Service

If equipment is returned to LEYBOLD, indicate whether the equipment is free of substances damaging to health or whether it is contaminated. If it is contaminated also indicate the nature of the hazard. LEYBOLD must return any equipment without a Declaration of Contamination to the sender's address (refer also to Chapter 3.1).

General

We reserve the right to alter the design or any data given in this handbook.

The illustrations are not binding.

Notes on how to use this handbook

Important remarks concerning operational safety and protection are emphasized as follows:

Warning



Indicates procedures that must be strictly observed to prevent hazards to persons.

Caution

Indicates procedures that must strictly be observed to prevent damage to, or destruction of the UL 200 helium leak detector.

Note

Indicates special requirements the user must comply with.

The references to diagrams, e.g. (2/5) consist of the Fig. No. and the Item No. in that order.

Contents

	Page
1 Description	3
1.1 General information	3
1.1.1 Purpose	3
1.2 Technical data	3
1.2.1 Physical data	3
1.2.2 Electrical data	3
1.2.3 Other data	4
1.3 Equipment	4
1.3.1 Supplied equipment	4
1.3.2 Accessories	4
1.4 Technical description	5
1.4.1 Forevacuum pump	5
1.4.2 Turbomolecular pump	5

	Page
1.4.3 Mass spectrometer	5
1.4.4 Ion source	5
1.4.5 Separation system	6
1.4.6 Ion collector	6
1.4.7 Electrometer amplifier	6
1.4.8 Mass spectrometer supply	6
1.4.9 Control	6
1.4.10 Operation and remote control	6
1.5 Description of the functions of the UL 200 ...	7
1.5.1 Vacuum Method	7
1.5.2 Partial Flow Method	7
1.5.3 Sniffer Mode	7
2 Operation	8
2.1 Installation of the instrument	10
2.1.1 Installation	10
2.1.2 Preparations for initial start-up	10
2.2 Electrical connections	10
2.3 Start-up (first pump-down cycle)	11
2.4 The controls and their functions	12
2.4.1 Overview of the controls and displays	12
2.4.2 The mains switch	12
2.4.3 Controls on the control panel	12
2.4.4 Controls on the hand unit	13
2.4.5 Displays on the hand unit	14
2.5 Equipment settings (menu structure)	15
2.5.1 Entry of equipment parameters	15
2.5.2 Password	15
2.5.3 Menu functions (overview)	16
2.5.4 Description of the individual menu functions	16
2.6 Equipment connections	27
2.6.1 RS 232 C interface (SERIAL)	27
2.6.2 Chart recorder outputs (RECORDER)	27
2.6.3 Control inputs and outputs (CONTROL) ...	27
2.6.4 Connection for accessories (OPTION)	28
2.7 Calibration	28
2.7.1 Internal calibration	28
2.7.2 External calibration	29
2.7.3 External calibration for sniffer applications ..	29
2.8 Shutdown	30
3 Maintenance	31
3.1 LEYBOLD service	31
3.2 Maintenance plan	31
3.2.1 Opening the UL 200	31
3.2.2 Exchanging the filter mats	32
3.2.3 Exchanging the oil	32
3.2.4 Cleaning	33
3.2.5 Exchanging the fuses	33
4 Messages	35
4.1 Equipment messages	35
4.2 Warnings and error messages	37
4.2.1 Warnings	37
4.2.2 Error messages	37
4.2.3 List of all warnings and error messages ...	38
5 Definition of terms	42

1 Description

1.1 General Information



The UL 200 helium leak detector is supplied ready for operation. Even so, we recommend that you carefully read the Operating Instructions and the Technical Handbook so as to ensure optimum operating conditions right from the start.

This handbook contains important information on functions, installation, start-up and operation of the UL 200.

Unpack the UL 200 helium leak detector immediately after it has been received even if it is to be put into operation at some later date.

Examine the shipping container for any external damage.

Completely remove all packaging materials.

Note

Retain the shipping container and the packaging materials in the event of possible complaints concerning any damages.

Check that the UL 200 helium leak detector is complete (see Section 1.4) and Carefully subject to a visual inspection.

If any damage is discovered please immediately inform the forwarding agent and the insurers. If it is required to exchange the damaged part please contact our orders department.

1.1.1 Purpose

The ULTRATEST UL 200 is a helium leak detector. This instrument may be used to localise and quantify leaks in test samples.

- when these have been evacuated first and are sprayed with helium on the outside. For this it is required that a vacuum connection is provided between the UL 200 and the test sample.
- In the case of small test samples, these may be evacuated by the UL 200 alone (vacuum method); in the case of larger volumes, the test samples must be evacuated together with a further pump system (partial flow vacuum method).
- when there is present in the test samples a helium overpressure and when the test sample is searched from the outside with a sniffer probe (sniffer method).

Caution



The UL 200 must not be operated while standing in water or when exposed to drip water. The same applies to all other kinds of liquids.

Caution



Avoid contact of the UL 200 with bases, acids and solvents as well as exposure to extreme climatic conditions.

1.2 Technical Data

1.2.1 Physical Data

Operation of the UL 200 helium leak detector is - as a rule - based on the counterflow principle.

Lowest detectable helium leak rate	
Vacuum mode	$\leq 5 \cdot 10^{-11}$ mbar·l·s ⁻¹
Sniffer mode	$\leq 1 \cdot 10^{-7}$ mbar·l·s ⁻¹
Greatest helium leak rate which can be displayed	0.1 mbar·l·s ⁻¹
Measurement range	9 decades
Detectable masses	2, 3 and 4
Mass spectrometer	180 ° sector field
Ion source	2 cathodes; iridium / yttrium
Max. inlet pressure (in measurement mode)	3 mbar
Equipment-specific processing time	time constant of the leak rate signal (blanked off, 63 % of the final value) < 1 s
Pumping speed at the inlet	S ≥ 1 l·s ⁻¹ FINE S ≥ 0.6 l·s ⁻¹ GROSS
Temperature coefficient	≤ 1 % / °C (10 to 40 °C)
Test port	DN 25 KF
Time until ready for operation	< 3 minutes

1.2.2 Electrical Data

Mains voltage (fixed)	100 V \pm 10 %; 50 / 60 Hz 110 - 120 V \pm 10 %; 60 Hz 220 - 240 / 230 V \pm 10 %; 50 / 60 Hz
Power consumption	≤ 350 W
Type of protection	IP 30
Mains cord	2.5 m

1.2.3 Other Data

Noise level	< 54 dBA
Valves	solenoid
Dimensions (W x H x D) in mm	490 x 430 x 250
Weight	37 kg
Permissible ambient temperature (during operation)	10 °C to 40 °C
Permissible storage temperature	- 40 °C to 60 °C
Max. rel. humidity	80 % non-condensing

1.3 Equipment

1.3.1 Supplied Equipment

UL 200 helium leak detector, ready for operation.

Mains cord, 2.5 m long

Operating Instructions

- ULTRATEST UL 200	GA 10.211
- Technical Handbook	TH 10.211
- Spare Parts List	ET 10.211
- Interface Description UL 200	SB 10.211
- TRIVAC D 2,5 E	GA 01.600
- Forms, Declaration of Contamination	

Blank flange DN 25 KF

Quick clamping ring DN 25 KF

DN 25 KF gasket

DN 25 KF centering ring

1 set of fuses

1 set of filter mats

2 L-type screwed connections (hose connections)

1 hose nozzle

1.3.2 Accessories

	Cat. No. / Ref. No.
Sniffer line for UL 200, 4 m	140 21 or 140 24
Retrofit calibrated leak	140 23
Extension cord for the hand unit, 8 m	140 22
Partial flow pump set	140 20; 140 25 140 26; 140 27; 140 28
QT 100 helium sniffer	155 94
Sniffer line for QT 100, 20 m long	155 76
Transport boy	140 97
Cart 200	140 93
Transport case	140 96
Set of connection plugs	200 28 782
PC software „LeakWare“	140 90

1.4 Technical Description

The UL 200 is capable of detecting and quantifying helium test gas flowing into a test sample having a leak by means of a selective mass spectrometer. Its operation is based on the counter flow principle, i.e. inflowing helium diffuses against the gas flow being pumped by the turbomolecular pump into the mass spectrometer whereas heavier gases, water vapour in particular, are held back. A cold trap using liquid nitrogen is thus not required.

The ULTRATEST UL 200 is composed of the following principal subassemblies:

- a 180 ° magnetic sector field mass spectrometer -the detection system
- a high vacuum pump system
- a valve block for controlling the gas flow
- the corresponding electrical and electronic subassemblies for supplying power and for signal conditioning. A detachable hand unit and a control panel on the instrument itself belong to this category.

1.4.1 Forevacuum Pump

A TRIVAC D 2.5 E rotary vane pump in the UL 200 serves as the forevacuum pump (2/16). All data and further information on this pump are given in the Operating Instructions GA 01.600.

The backing pump generates the forepressure required for operation of the turbomolecular pump.

In the vacuum mode the test sample is also evacuated, whereas in the sniffer mode the necessary gas flow is generated.

1.4.2 Turbomolecular Pump

A TURBOVAC TMP 35 LS is used in the ULTRATEST UL 200. The turbomolecular pump generates the high vacuum necessary for operation of the mass spectrometer.

Heavier gases are evacuated owing to the high compression, whereas the helium test gas is able to diffuse upstream into the mass spectrometer.

This pump offers two special features:

- Ahead of the turbomolecular stage (high pumping speed) there is a screw-type stage which provides a high compression. Thus the UL 200 may switch to the measurement mode already at high intake pressures.
- The TMP 35 LS has a side connection. Thus the high pumping speed may be utilised in the FINE mode at the inlet of the leak detector. This considerably reduces the response time of the leak detector. (Response time = volume of the test sample / effective pumping speed for helium)

The compression capacity of the TMP and the pumping speed of the forevacuum pump determine the sensitivity of the entire arrangement.

1.4.3 Mass Spectrometer

The mass spectrometer, MS (2/7) is chiefly composed of the ion source, the magnetic separator and the ion collector (1/5).

The ion source ionizes neutral gas particles and generates from these an ion beam. The positively charged ions are accelerated out of the ion source and then enter the magnetic field. Here they are deflected along a circular path, the radius of which depends on the mass-to-charge ratio of the ions. Only the helium ions are able to meet the separating conditions and arrive at the ion collector, where their presence can be measured as a current by an electrometer amplifier.

1.4.4 Ion Source

Electrons having an energy of 80 eV are used in the ion source.

The electrons which are emitted by the hot cathode (1/1)

Key to Fig. 1

- 1 Cathode 1
- 2 Anode
- 3 Cathode 2
- 4 Amplifier
- 5 Ion collector
- 6 Shield for ion collector
- 7 Suppressor
- 8 Magnetic field
- 9 Intermediate orifice
- 10 Extractor orifice
- 11 Guard ring

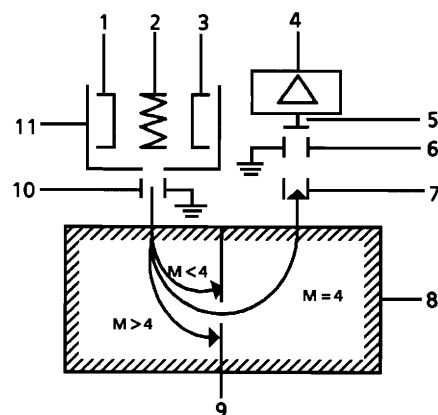

Fig. 1 Schematic diagram of the mass spectrometer

are attracted by the positively charged anode (1/2). But they do not immediately impinge on the anode (1/2); instead they oscillate to and fro several times until they finally arrive at the filament of the anode (1/2).

On this path they ionize the gas atoms by impact. These ions are extracted from the ion source by a ground-connected extractor orifice (1/10) and enter the magnetic separation system.

In order to avoid deposits of polymerized hydrocarbons (insulating layers which may impair sensitivity) the anode is heated while the UL 200 runs up.

Due to the operating temperature of the ion source (cathode heater), this is no longer required after the instrument has run up and the anode heater is then switched off for this reason.

Cathodes (1/1) and (1/3) are made of iridium tape which is coated with yttrium oxide. Due to this coating, the operating temperature of the iridium filaments is much lower compared to tungsten filaments, and these offer excellent resistance to burnout, embrittlement, oxygen, water vapour and hydrocarbons.

1.4.5 Separation System

A magnetic sector field (1/8) with 180 ° deflection is used as the separating system. Due to the inhomogeneous magnetic field perpendicular to the ion beam, additional focusing of the ions is attained in this direction (Z-focusing) resulting in a high sensitivity.

Unwanted ions from other gases are kept away in addition by means of the intermediate orifice (1/9).

1.4.6 Ion Collector

The ion collector (1/5) is composed of a tube-shaped suppressor and the actual collecting plate.

The suppressor (1/7) carries a positive potential which is slightly less than the anode potential. It is the purpose of the suppressor to prevent scattered ions which have a lower nominal energy from arriving at the collector. This improves resolution at low detection rates.

The impinging ions are collected by the collecting plate where they are neutralized. The corresponding current flows into the connected amplifier.

1.4.7 Electrometer Amplifier

The electrometer amplifier amplifies the current which is generated on the ion collector of the mass spectrometer. Gain of this amplifier can be switched over in four stages. The control assembly is responsible for the switching over and processing of the analogue output signal. The detection limit in the most sensitive range amounts to approximately $1 \cdot 10^{-15}$ A.

1.4.8 Mass Spectrometer Supply

The subassembly generates all the voltages and currents required for operation of the mass spectrometer:

- anode heating voltage
- cathode heating voltage
- anode voltage
- suppressor voltage

Errors in the mass spectrometer are detected and signalled to the control assembly. The control assembly monitors the mass spectrometer supply.

1.4.9 Control

The control assembly is the central assembly of the leak detector's electronics. All other subassemblies are controlled and monitored by this assembly. The microprocessor which is located here is thus continuously informed about the status of the entire leak detector and can respond accordingly. In order to accept commands from the operator and to output measured values and messages, the control subassembly is linked to the operating and display subassembly.

1.4.10 Operation and Remote Control

These two subassemblies are used to communicate with the operator. They accept commands from the key pad and output measurement results and messages via the display components.

1.5 Description of the Functions of the UL 200

The mass spectrometer (2/7) only operates under high vacuum conditions, i.e. the pressure here must always remain below 10^{-3} mbar. This vacuum is generated by the turbomolecular pump (2/6) with the support of the rotary vane pump (2/16). Except during the evacuation phase, the valve (2/3) between these two pumps always remains open so that this is ensured. In this state the UL 200 reverts to the standby mode; after completion of run-up, for example. All other valves are then closed. The pressure p_V between the two pumps is measured with a Pirani gauge (2/4) and this pressure lies in the range between 3 to 10^{-3} mbar while in the measurement mode. This pressure must not exceed a value of 3 mbar as otherwise the turbomolecular pump will not be capable of maintaining the vacuum in the mass spectrometer.

1.5.1 Vacuum Method

For the purpose of leak detection on a test sample (vacuum method), the sample has to be evacuated so that helium which is sprayed on to the outside, can enter through any leaks due to the pressure differential for detection by the leak detector.

The test sample is evacuated - START push-button (5/3) - by the rotary vane vacuum pump (2/16). In the case of larger test samples an additional external partial flow pump (2/15) with a corresponding linking valve (2/12) may be connected in parallel as required.

Inlet valve (2/14) is opened so that the evacuation may take place. At the same time valve (2/3) is closed in order to prevent an unacceptable pressure increase in the mass spectrometer.

In this context (valve (2/3) closed) the turbomolecular pump is operated without being supported by the rotary vane pump. Since generally no gas is pumped out of the mass spectrometer, p_V remains constant or increases only slowly.

The condition for the evacuation process described here is maintained until the inlet pressure p_E (2/13) has dropped ≤ 3 mbar. Now the valves (2/5) and (2/3) are opened and (2/14) is closed. Possibly present helium may now flow upstream against the pumping direction of the turbomolecular pump (2/6) into the mass spectrometer where it is detected. This measurement mode is called GROSS. In this mode, leak rates down to 10^{-9} mbar·l·s⁻¹ can be detected.

Since the rotary vane vacuum pump (2/16) continues to evacuate the test sample via valves (2/3) and (2/5) the inlet pressure p_E will continue to drop. When the pressure drops below $p_E < 0.2$ mbar, the UL 200 will switch to

the FINE mode, i.e. valve (2/5) closes and valve (2/8) opens so that the gas flow enters the turbomolecular pump (2/6) at the side. This offers two advantages:

- A part of the high pumping speed of the turbomolecular pump remains available for further evacuation of the test sample. The response time of the leak detector is reduced (response time is inversely proportional to pumping speed).
- The advantages offered by the counterflow principle can still be utilized.

In the FINE mode the full sensitivity of the UL 200 is reached.

When the leak detection process is stopped - STOP push-button (5/2) - all valves except valve (2/3) are closed.

Valve (2/10) is opened during venting.

1.5.2 Partial Flow Method

In the partial flow mode the test sample is additionally evacuated by an auxiliary pump. Using the optional partial flow pump set (see Chapter 1.3.2) offers to the user the following advantages:

- faster response
- entry into the measure mode already at an inlet pressure of the 1000 mbar
- faster venting of large test objects

1.5.3 Sniffer Mode

The UL 200 may simply be converted into a sniffer leak detector via two rugged sniffer lines (Cat. No. 140 21 or 140 24).

For this the KF flange of the sniffer line is connected to the inlet flange (3/2) and the sniffer mode is selected through menu item 2 (see Chapter 2.5.4). After pressing START, the inlet valve (2/14) opens. The sniffer lines have been designed in such a way that the UL 200 is operated in the FINE mode (as described in Chapter 1.5.1).

A calibration according to Chapter 2.7.3 is recommended.

In the measurement mode the helium present in the ambient air is now indicated as the leak rate (about $2 \cdot 10^{-6}$ mbar·l·s⁻¹). Smaller leaks may be detected by pressing the ZERO push-button (Chapter 2.4.4).

2 Operation

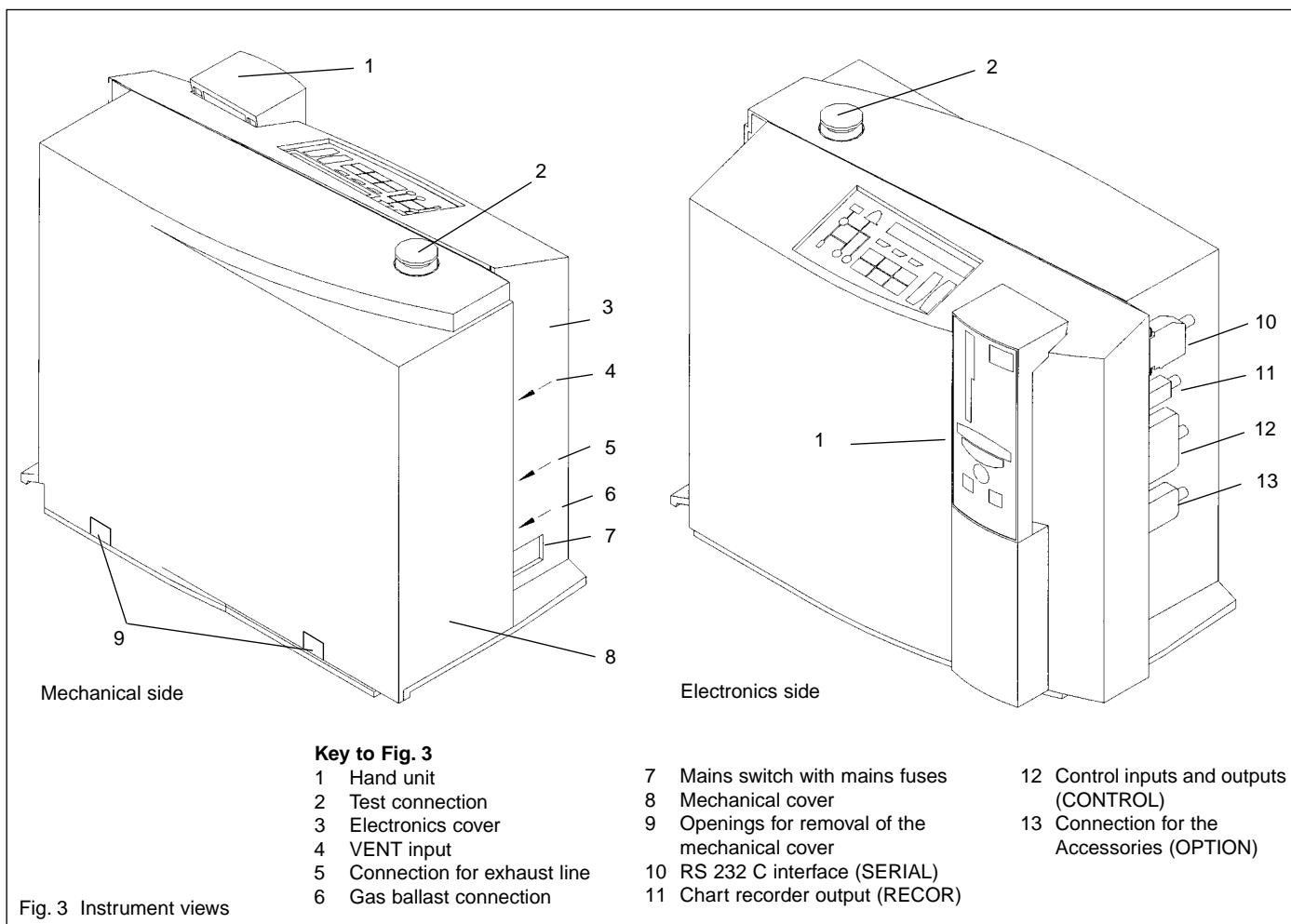
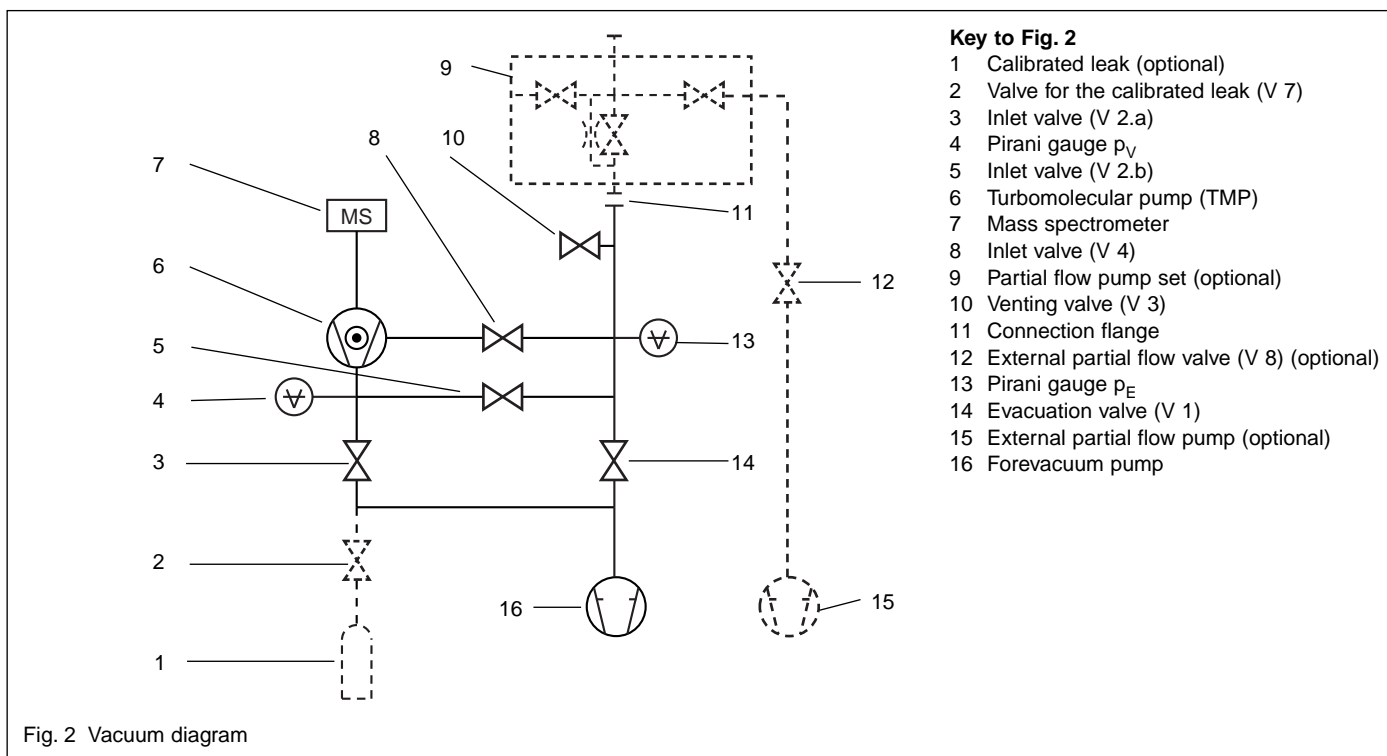

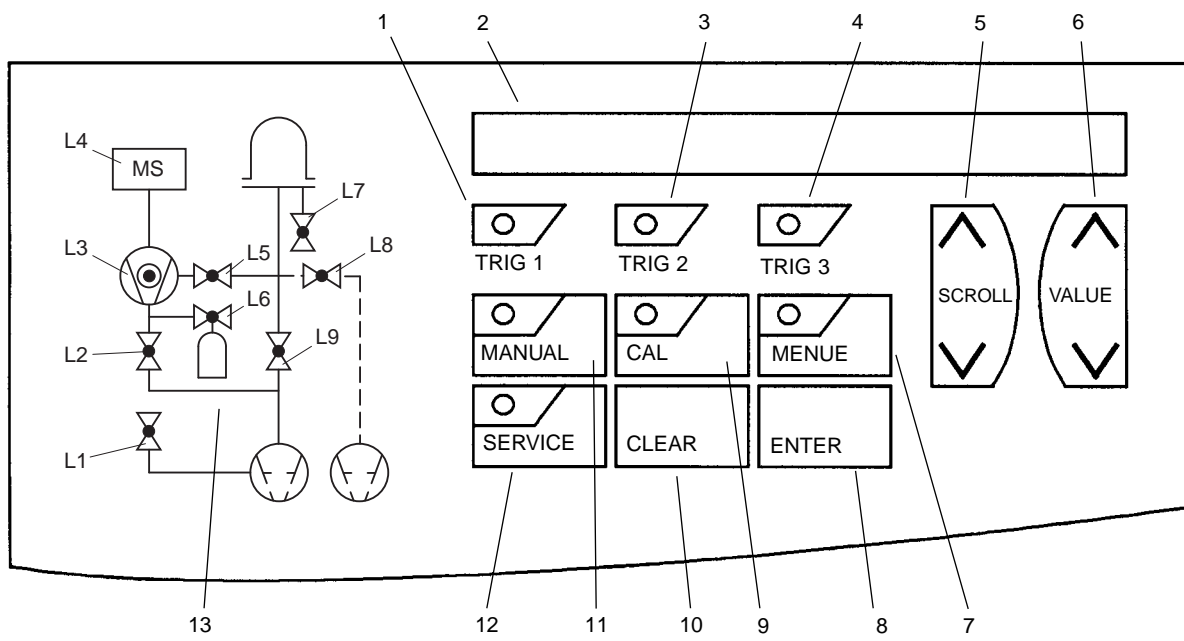

Key to Fig. 4

- | | | |
|----------------------|----------------------|----------------------------------|
| 1 LED for trigger 1 | 6 VALUE push-button | 11 MANUAL push-button |
| 2 LCD display | 7 MENU push-button | 12 SERVICE push-button |
| 3 LED for trigger 2 | 8 ENTER push-button | 13 Vacuum diagram (simplified) |
| 4 LED for trigger 3 | 9 CAL push-button | |
| 5 SCROLL push-button | 10 CLEAR push-button | L 1 to L 9 light emitting diodes |

Fig. 4 Control panel

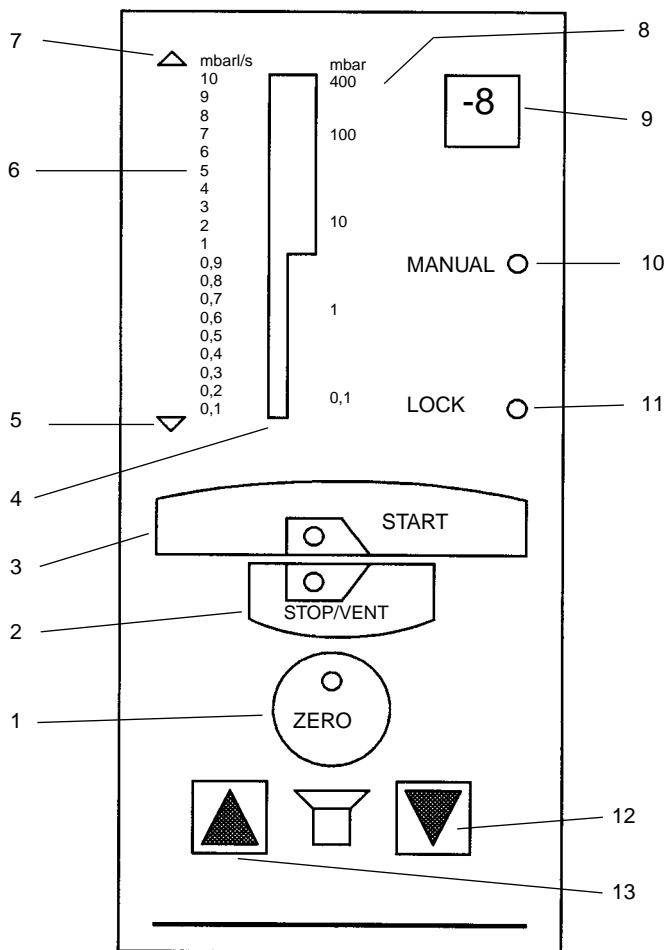

Key to Fig. 5

- | | |
|-----------------------------------|---|
| 1 ZERO push-button | 8 Scale for the pressure in the test sample |
| 2 STOP / VENT push-button | 9 Exponent |
| 3 START push-button | 10 MANUAL LED |
| 4 LED-Bargraph display | 11 LOCK LED |
| 5 Underflow display (under range) | 12 Acoustic signal quieter |
| 6 Leak rate scale | 13 Acoustic signal louder |
| 7 Overflow display (over range) | |

Fig. 5 Hand unit

2.1 Installation of the Instrument

2.1.1 Installation

Caution



In order to ensure adequate ventilation of the UL 200, a space of at least 10 cm must be kept unobstructed to the sides. Also the clearance at the rear must be no less than 10 cm. Moreover, the ventilation slits at the holder for the hand unit under the UL 200 as well as under the recess for the handles must not be covered. For this reason you must never place the UL 200 on thick and soft mats (foam rubber, for example).

The UL 200 is capable of reliable operation under normally encountered industrial conditions (for these refer also to Chapter 1.2.3).

2.1.2 Preparations for Initial Start-Up

The UL 200 is supplied ready for operation.

Caution



Before operating the instrument for the first time, you must remove the yellow shipping seals on the gas ballast connection (3/6) and the exhaust connection (3/5). Retain the shipping seals in case you want to ship the equipment at some later date.

When operating the UL 200 in closed rooms and especially when detecting leaks in the sniffer mode on large test objects or when actuating the pump's gas ballast, you should connect the „EXHAUST“ (3/5) connection to a line leading to the outside of the building. In rooms where the helium concentration significantly exceeds 5 ppm, the connection of fresh air feed lines is also recommended. Air which is free of helium should be supplied via a hose line which is connected to the „VENT“ connection (3/4). Additionally, the gas ballast connection „GAS BALLAST“ (3/6) should also be supplied with fresh air.

With the aid of the angled bracket which is supplied with the instrument it is possible to easily connect plastic tubes (6 mm outside diameter and 4 mm inside diameter).

Note

Before starting the instrument for the first time, check the oil level in the forevacuum pump.

In order to remove the mechanical cover, turn the UL 200 first in the way as shown in the left part of Fig. 3. Insert a flat blade screwdriver into the openings (3/9) in order to disengage the mechanical cover (3/8) at the lower side.

For this also refer to Chapter 3.2.1 with figures 6 and 7.

Then pull the mechanical cover upwards to the stop and take it away to the front (please refer to the enclosed operating instructions for the pump when wanting to check the oil level).

2.2 Electrical Connections

Note

In general, the regulations as laid down in the currently valid VDE 0100 must be observed.

Caution



Before connecting the instrument to the mains you must make sure that the mains voltage rating of the instrument coincides with the locally available mains voltage.

The mains voltage rating for the instrument can be read off from the name plate under the handle at the mains switch.

The mains voltage setting of the UL 200 is fixed and can not be changed.

A separate fuse for each of the mains conductors has been integrated into the mains socket (3/7).

The mains voltage is applied to the instrument via the detachable mains cable which is supplied with the instrument. A mains socket is available for this purpose at the left hand side of the instrument.

Caution



Only 3-core mains cables having a protective ground conductor must be used. Operation of the instrument where the ground conductor has been left unconnected is not permissible.

2.3 Start-Up (First Pump-Down Cycle)

No.	Activity	Response	Display on the control panel Fig. 4	Display on the hand unit Fig. 5
1	Check the mains voltage and connect the mains cable;	--	--	--
2	Blank off the connection flange (3/2)	--	--	--
3	Set the mains switch (3/7) to the „1“ position	Running up of the forevacuum pump and the turbomolecular pump. Pumpdown of the detection system. The automatic self test starts. The emission is switched on.	„LEYBOLD INFICON“ „UL 200 Version x.x“ Light emitting diode L2 (4/13) is on. Light emitting diode L3 (4/13) flashes. „Running Up TMP: 1050 Hz“ „Emission OFF ==> ON“ Light emitting diode L4 (4/13) flashes.	All display components are on. ROM and RAM test. Decimal point (5/9) flashes. Test of the display components. TMP speed is indicated on the bargraph display (5/4).
4	--	Indication of operational readiness by an acoustic signal.	„Standby“ Light emitting diodes L2, L3 and L4 (4/13) are on.	Display of helium background or the detection limit on the bargraph display (5/4) and exponent (5/9).
5	Press the START push-button (5/3) briefly	Initiation of the measurement process. Pumpdown of the dead volume at the inlet.	„Evacuation PE = 3.5+1 “ Light emitting diodes L3 and L4 are on. Light emitting diode L2 is off. Light emitting diode L9 is on.	START display (5/3) flashes; The pressure in the test sample (5/8) is indicated on the bargraph display (5/4).
6	--	The first measurement readout is obtained at an inlet pressure for $p_E < 3$ mbar (GROSS mode). When the inlet pressure $p_E < 0.2$ mbar the instrument changes to the FINE mode.	„LR = 3.1E-09 PE = 1.5 E+0“ Light emitting diodes L2, L3, L4 and L9 are on. Light emitting diode L9 is off. Light emitting diodes L2, L3, L4 and L5 are on.	START display (5/3) is on; Display of leak rate (5/6) on the bargraph display (5/4) and exponent (5/9). --
7	Press the STOP push-button (5/2) for over 1.5 s	Starting of the stopping process. Starting of the venting process.	„Vent“ Light emitting diode L5 is off. Light emitting diode L7 is on. Light emitting diodes L2, L3 and L4 are on.	Display of helium background on the bargraph display (5/4) and exponent (5/9); Vent LED (5/2) is on.
8	Open the test port (3/2)	--	--	--
9	Connect the test sample	--	--	--
10	Press the START push-button (5/3) briefly	Starting of the measurement process. Pumpdown of the dead volume at the inlet.	Light emitting diode L7 is off. „Evacuation PE = 3.5 E+1 “ Light emitting diodes L3 and L4 are on. Light emitting diode L2 is off. Light emitting diode L9 is on.	START display (5/3) flashes; Display of inlet pressure (5/8) on the bargraph display (5/4).
11	--	The first measurement readout is obtained at an inlet pressure for $p_E < 3$ mbar (GROSS mode). When the inlet pressure $p_E < 0.2$ mbar the instrument changes to the FINE mode.	„LR = 3.1E-09 PE = 1.5 E+0“ Light emitting diodes L2, L3, L4 and L9 are on. Light emitting diode L9 is off. Light emitting diodes L2, L3, L4 and L5 are on.	START display (5/3) is on; Display of leak rate (5/6) on the bargraph display (5/4) and exponent (5/9). --
12	Spray the test sample with	Display of the leak rate	„LR = 5.1 E-07 PE = 1.5 E-1	Leak rate on bargraph display (5/4) and exponent (5/9).
13	Press the STOP push-button (5/2) for over 1.5 s	Starting of the stopping process. Starting of the venting process.	„Vent“ Light emitting diode L5 is off. Light emitting diode L7 is on. Light emitting diodes L2, L3 and L4 are on.	Display of helium background on the bargraph display (5/4) and exponent (5/9); Vent LED (5/2) is on.
14	Disconnect the test sample	--	--	--

2.4 The Controls and their Functions

2.4.1 Overview of the Controls and Displays

Except for the mains switch, all controls and displays are located on the control panel (Fig. 4) and on the hand unit (Fig. 5)

The hand unit is detachable and linked to the instrument via a connecting cable. Magnets have been built into the hand unit, so that it may easily be attached to any magnetizable surface. If required, the connection cable of the hand unit leading to the UL 200 can be extended (extension cable Cat. No. 140 22).

The controls and displays are shown in Fig. 5.

The control panel on the UL 200 (Fig. 4) also contains the corresponding menu and function push-buttons. These are described in Chapter 2.4.3.

2.4.2 The Mains Switch

Operation of the mains switch (3/7) switches the entire instrument on or off.

2.4.3 Controls on the Control Panel

MANUAL push-button

Via the **MANUAL** push-button (4/11) it is possible to switch the manual ranging feature on and off. Once this function has been selected it is then possible to enter the display range for the leak rates (exponent) through the **VALUE** push-button (4/6).

When pressing the **MANUAL** push-button (4/11) the following happens:

The LED in the **MANUAL** push-button (4/11) and the **MANUAL LED** (5/8) on the hand unit come on.

The exponent (5/9) on the hand unit is frozen. When the leak rate changes it is only required to observe the bargraph display (5/4).

In case of a range overflow, the upper arrow (5/7) at the bargraph on the hand unit comes on and in the case of range underflow, the lower arrow (5/5) at the bargraph on the hand unit comes on.

The range of the exponent displayed by the LCD display (4/2) is also restricted. The same applies to the dynamic range of the chart recorder signal at the **RECORDER** output (3/11) (see description for menu item 13). The analogue voltage at pin 4 is constant. Only the signal at pin 1 may be used for logging of the change in the leak rate.

Note

The trigger thresholds (menu item 1) should fall into the range of the bargraph display. Trigger levels outside the range of the bargraph display are not usable in the case of manual range selection.

The LED in the **MANUAL** push-button is not on and the **MANUAL** status indicator (5/10) is off:

The range is selected automatically. The full measurement range is available.

SERVICE push-button

Pressing of the **SERVICE** push-button (4/12) activates or deactivates the service menu (see Chapter 2.5). When the service menu has been selected, the status indicators (4/7) and (4/12) come on. If the automatic functions have been switched off in the service menu (service menu item 70) the UL 200 will be restarted after the service menu has been exited, i.e. all monitoring and automatic functions are switched on again. After this, the UL 200 will be running in the Standby mode.

CAL push-button

Pressing the **CAL** push-button (4/9) starts a calibration process which may be run either in connection with an internal calibrated leak (optional) or an external calibrated leak (see Chapter Calibration). The UL 200 will then control everything else on its own and will inform the operator via the LCD display (4/2). The UL 200 autonomously decides whether to use the internal calibrated leak or external calibrated leak which is connected to the test port (3/2), depending on the instrument mode at the time of the key-press.

Pressing of the **CAL** push-button in the measurement mode: external calibration.

Pressing the **CAL** push-button in the Standby/Vent mode: runs an internal calibration, provided an internal calibrated leak has been built-in.

The process differs for the different operating modes. If the calibration process is to be performed with an external calibrated leak, then the calibrated leak must be connected to the inlet or the test sample before operating the push-button. Switchover between external and internal calibrated leak is possible by operating the **START** (5/3) and **STOP / VENT** (5/2) push-buttons.

The calibration process may be cancelled by pressing the **CAL** push-button (4/9) or the **CLEAR** push-button (4/10).

LED in the push-button is on: calibration process is active.

LED in the push-button is off: calibration process is inactive.

CLEAR push-button

The **CLEAR** push-button (4/10) is used to cancel processes and functions which have been started. Moreover, this push-button may be used to acknowledge warnings and error messages.

Also this push-button may be used to reset a value which has been changed through VALUE in a menu.

ENTER push-button

The **ENTER** push-button (4/8) is used to acknowledge and accept parameters which have been set up on the UL 200.

If several parameters can be changed in a single menu line, pressing of this push-button advances to the next parameter.

When the parameter is being accepted, the message „Updating Parameter“ is displayed briefly or the next parameter is indicated.

MENU push-button

The **MENU** push-button (4/7) permits many entries though which instrument settings can be made or for running of special instrument functions. For this also refer to Chapter 2.5.

Pressing the MENU push-button (4/7) lets the instrument enter the menu mode and this mode can be exited by pressing the MENU push-button once more.

After pressing the MENU push-button, that menu line which was active upon leaving the menu mode before is displayed. The desired menu line is selected by pressing the SCROLL push-button (4/5).

Within a menu line, the settings or values are changed by pressing the VALUE push-button (4/6).

Each change which is made within a menu line must be acknowledged by pressing the ENTER push-button (4/8). Otherwise the changed value will not be accepted by the UL 200.

LED in the push-button is on: menu mode is active.

LED in the push-button is off: menu mode is inactive.

SCROLL push-button

The **SCROLL** push-button (4/5) permits the selection of a menu items. Also refer to Chapter 2.5.1.

VALUE push-button

With the aid of the **VALUE** push-button (4/6) it is possible to change settings or values. Only the parameters which flash can be changed by operating the VALUE push-button. Also refer to Chapter 2.5.1.

2.4.4 Controls on the Hand Unit

An overview of the controls on the hand unit is given in Fig. 5.

START push-button

Based on the operating modes Standby or Vent of the UL 200, the START push-button (5/3) is used to start the measurement mode by evacuating the connected test sample. Here the UL 200 will operate either with automatic ranging or it will only display the measured values within a fixed range which has been selected by the operator (Manual).

The status of measurement readiness is indicated to the operator by a green LED at the START push-button. During the pumpdown phase this LED flashes. As soon as the status of measurement readiness has been reached, this LED stays on continuously.

When pressing the START push-button in the Standby mode, the internal Zero level is taken over anew, provided the UL 200 has been running in the Standby or Vent status for at least 10 s.

STOP / VENT push-button

The STOP / VENT push-button (5/2) has two different functions, depending on how long it is pressed:

STOP function

Based on the measurement mode of the UL 200, a brief press of the STOP push-button (5/2) interrupts the evacuation process of the test sample and the measurement mode is interrupted. The duration of this key press must be no longer than the time which is defined in menu item 22 (see Chapter 2.5.4). The default time is 1.5 s. The UL 200 will return to the Standby mode, i.e. all valves except valve V2a (2/3) are closed. This condition is indicated to the operator by the green LED in the START push-button (5/3) which is turned off.

After pressing the STOP / VENT push-button (5/2) the LCD display (4/2) will indicate the message „Standby“.

VENT function

When pressing the STOP / VENT push-button (5/2) for a period of time which exceeds the time as defined in menu item 22 (1.5 s default), the connected test sample is vented as soon as this time has elapsed. This is done by opening of the venting valve V3 (2/10). This operating mode is indicated to the operator by the green LED in the STOP / VENT push-button which comes on.

The venting valve may be closed again by pressing the STOP / VENT push-button briefly once more. The UL 200 will then return to the Standby mode. The „VENT“ display is turned off.

In the Standby mode and after a transitional period of

10 s, the helium background of the UL 200 is continuously monitored. This helium background may be indicated when selecting menu function „21: System BG display on“. The helium background determination process takes up to 10 s depending on the sensitivity setting. The helium background serves as the Zero level for the subsequent measurements.

When the START push-button (5/3) is pressed before this process has been completed, the Zero determination process is cancelled and the previous Zero value will be used once more.

The automatic gas ballast control is also monitored during the Standby mode. The monitoring facility to control the gas ballast valve will start 30 s after the UL 200 has returned to the Standby mode (see description for menu item 3).

ZERO push-button

A constant leak rate reading may be suppressed by pressing the ZERO push-button (5/1), i.e. a constant helium background within a test sample. This push-button is only active in the measurement mode.

The exponent on the hand unit is retained in the case of „Zero“ when the leak rate display always remains at the upper decade of the bargraph display. If the leak rate is indicated in the lower decade, the exponent is decremented by one in the case of „Zero“. Thus the displayed leak rate can always be suppressed by at least one decade so as to increase resolution.

Example

A leak rate of $4.1 \cdot 10^{-8}$ mbar·l·s⁻¹ can be displayed in two ways on the hand unit:

- The exponent indicates -8 and the narrow part of the bargraph display is fully on and the wider section is on up to number 4.
- The exponent indicates -7 and only the lower narrow section of the bargraph display is on up to number 0.4.

In both cases the exponent -8 and the bargraph display is dark after pressing of ZERO.

After the ZERO push-button (5/1) has been pressed, the currently indicated leak rate is stored as the „Zero level“ without changing the internal Zero level which has been determined by the Zero determination process.

Only values above this Zero level are indicated so that resolution of the displayed measurement signal is improved.

Note

It is not possible to reduce the detection limit of the instrument by pressing the ZERO push-button (5/1).

The ZERO function is cancelled by pressing the ZERO push-button once more. The Zero function is also can-

celled automatically as soon as the STOP / VENT push-button (5/2) is pressed.

The ZERO function has an effect on all output devices such as remote control, LCD display, chart recorder, triggers and RS 232 interface.

Should the helium background which has been suppressed with the aid of the ZERO push-button change in such way that no measured value is indicated for over $t = 5$ s, then the Zero level is readjusted automatically.

Acoustic signal

The acoustic signal is used to indicate the leak rate. An acoustic signal is also generated in the case of error messages. For details please refer to the description of menu item 18 in Chapter 2.5.4 and in Chapter 4.2.

The volume of the acoustic signal can be increased by operating the push-button (5/13) to the left of the loudspeaker. With the push-button (5/12) to the right of the loudspeaker the volume of the acoustic signal may be reduced.

2.4.5 Displays on the Hand Unit

Measurement range display

Here the leak rate is indicated by way of a bar (5/4). In case of a range overflow, the upper arrow (5/7) at the bargraph on the hand unit comes on and in the case of range underflow, the lower arrow (5/5) at the bargraph on the hand unit comes on.

The corresponding exponent (5/9) is indicated at the top to the right of the bargraph display.

Depending on the kind of hand unit which is supplied, the measured leak rate (bargraph display together with the exponent display) is indicated in mbar·l·s⁻¹ or Pa m³·s⁻¹.

Two leak rate decades can be indicated by the bargraph display (5/4). The panel for the upper leak rate decade (1 ... 10) is twice as wide as that for the lower decade (0.1 ... 1).

LOCK LED

The LOCK LED (5/11) comes on when the hand unit has been locked. For details on this please refer to the description for the menu line in Chapter 2.5.4.

MANUAL LED

The MANUAL LED (5/10) comes on when the manual ranging mode has been selected by pressing the MANUAL push-button (4/11) on the control panel.

2.5 Equipment Settings (Menu Structure)

Via the menu, the UL 200 may be adapted to prevailing ambient and operating conditions in a flexible manner. In order to provide a better overview, the menu has been divided into three parts. The individual menu items are numbered consecutively.

The first part - the basic menu - contains functions (No. 1 ... 9) which can be changed frequently and quickly when running a particular application. The second part - the extended menu - (No. 10 ... 49) permits access to those parameters which may have to be changed only once during initial start-up or in the case of changed ambient conditions, i.e. parameters which have to be changed only rarely. The third part - the service menu - (No. 50 ... 99) is used for servicing the UL 200 or for assistance during troubleshooting.

For reasons of clarity, only the basic menu is generally accessible. The extended menu can be accessed after entering a password in menu item No. 9.

The service menu can be accessed by pressing the Service push-button (4/12). When only wanting to display internal parameters of the instrument, the scroll push-button may be operated to move between the menu items of the service menu without necessarily having to enter the second password. However, if modifications are to be made here or for access to further test modes, the entry of the correct second password is required (with the exception of menu item 81). This password will only be made available after suitable training by Leybold.

2.5.1 Entry of Equipment Parameters

Pressing the MENU push-button (4/7) enters the menu mode. Refer also to Chapter 2.4.3.

The menu items are selected by operating the SCROLL push-button (4/5). The individual menu items are numbered consecutively. Pressing the upper symbol of the push-button decrements the menu item number by 1 (i.e. visually one passes through the menu table to the top) and operation of the lower symbol of the push-button increments the menu item level by one. When arriving at the end of the menu items, menu item „1“ is then selected automatically.

Those parameters which can be modified within a menu item are displayed flashing. At first the currently valid value of the parameter is displayed. The corresponding values may then be changed through the VALUE push-button (4/6). Each value which has been changed must then be acknowledged by operating the ENTER push-button (4/8) so that the UL 200 accepts and stores the newly changed value. At the same time, the next parameter which can be changed is selected or the message

„Updating Parameter“ is displayed.

Pressing the MENU push-button (4/7) once more exits the menu mode.

All parameters which are essential for proper operation remain stored when the instrument is disconnected from the mains.

A detailed example describing the way in which a parameter is changed is given in Chapter 2.5.4 under „01: Trigger“.

Note

If the message „Keyboard locked“ is displayed when trying to change a parameter, this means that access to the keyboard has been restricted. At this moment further entries can not be made. The keyboard must be unlocked first. For this refer to menu item „14: Control by“.

2.5.2 Password

In menu item 09 the operator is asked for the entry of a password in order to be able to access the further menu items (10 to 49).

The default password as entered in the factory is **0013**.

Note

The password may be changed by the operator at any time. The password should be kept at a secure place.

Entry of the password

This entry is performed digit by digit through the VALUE push-button (4/6) and the ENTER push-button (4/8).

When selecting menu item 09 for the first time, the message „locked“ will be displayed flashing to the right.

Pressing the VALUE push-button (4/6) lets the first digit of the password which is to be changed, flash. Pressing this push-button once more increments or decrements the displayed number starting at „0“. Acknowledge the desired number by operating the ENTER push-button (4/8). As soon as this has been done, the next digit is shown flashing. This number too, is changed by operating the VALUE push-button and acknowledged by operating the ENTER push-button.

All four digits are entered in this manner.

After having operated the ENTER push-button (4/8) for the fourth time, the check starts. The message „Password OK“ or „Password failed“ will appear for 2 seconds. In the case of an incorrect password, „locked“ will be displayed once more. In the case of the right password the message „opened“ will appear.

Access to the protected functions remains possible until the password is changed. Access to protected functions remains possible even if the instrument has been disconnected from the mains in the mean time.

Caution This type of locking will not protect the instrument against a fully intentional act of sabotage.

2.5.3 Menu Functions (Overview)

All menu functions of the UL 200 are described briefly in the following list. For detailed information on each menu item please refer to Chapter 2.5.4.

Display example (4/2)	Brief description
Basic menu:	
01:Trigger 1 3.0E+05	Set leak rate trigger values
02:Mode Vacuum	Select leak detection mode (vacuum, partial flow or sniffer leak detection)
03:Gas Ballast closed	Remove helium background with the gas ballast facility
04:Test <enter>	Check the measurement signal for helium
09:Password 1 locked	Enter password for access to the extended menu
Extended menu:	
10:EVAC Time 1 30s	Monitoring of gross leaks
11:Sensitivity normal	Select sensitivity
12:Display LR + PE	Select information which is to be displayed on the LCD (4/2)
13:Recorder LR	Select chart recorder function (3/11)
14:Control by Keyboard 1	Select control means (START / STOP / VENT)
15:RS232 Baud rate 9600	SERIAL connection (3/10), setting up of parameters
16:Relay Mode 1	Definition of the function output
18:Alarm Trigger off	Select acoustic warning
19:LCD Contrast 8	Change contrast for the LCD text display line (4/2)
21:System BG display off	Display / suppress helium background during Standby
22:Vent Delay 1.5s	Set venting delay time
23:System integration off	Switch systems leak detection mode on / off
24:Request for CAL off	Automatic request for calibration on / off
25:Mass 4	Select mass
26:Date 09.Apr.96	Set date and time
27:Language english	Language select
28:Power Frequency 50Hz	Set mains frequency
29:Pumping Speed 25 m ³ h ⁻¹	Entry of the pumping speed for the partial flow pump.
30:Cal Leak 6.9E-7 mbar·l·s ⁻¹	Entry of the value of the calibrated leak (internal)
31:Only GROSS off	Locks the FINE mode

Display example (4/2)	Brief description
32:ZERO-time 1 s	Entry of time constant for sliding Zero
33:QUICK-Pump time	Entry of time defining sequences in partial flow mode
49:Change Password 1 ?	Change password 1
Service menu:	
50:Password 2 locked	Permit changes in the service menu
51:2.4 14000 D970000000	Display software version number, catalogue number and serial number
52:01 E53 03.07.96 13:00	List error log
53:Status to RS232 <Enter>	Output status report through RS 232
54:Scan To Rec <Enter>	Output mass spectrum
55:Value PE 1.2E+2 mbar	Display (internal) measurement quantities
56:Cycles V1 0012354	Display valve cycle counter
57:Operat.Time 111111h	Operating hours counter
58:Task 00.00.00	Display process status
59:Offset 00.000V	Display characteristic quantities for leak rate calculations
70:Automatic on	Switch automatic functions on / off
71:Valve Supply Auto	Select valve supply voltage
72: 2a V1	Display valve status
73:Emission On	Switch emission on / off
74:Anode M4 462V	Run manual mass alignment
75:Amp Emi 500G 0.0035V	Display preamplifier voltage
76:Gain A 16 0.087V	Display A/D converter voltage
77:Cathode 1	Select cathode
78:Unit mbarl/s	Select unit of measurement
79:Default Reset <enter>	Reset parameters to default
82:Cal Leak Factor 3.39	Factor for the calibrated leak (internal)
90:Amp-Test <enter>	Preamplifier test
91:Burn In On <enter>	Burn-in test
92:Adjust Resistor	Auxiliary alignment functions
99:Change Password 2 ?	Change password 2

Via menu item 14 it is possible to lock the keyboard. This ensures that parameters of menu items 01 to 08 can not be changed.

2.5.4 Description of the Individual Menu Functions

The individual menu items are described in the following. The number and the general term of the menu item are printed in bold face, followed by the status of the text line as set up in the factory (default status).

01: Trigger 1 3.0E+05 Set leak rate trigger values

Here three trigger threshold levels can be entered independently of each other. The two-digit factor and the

exponent may be modified separately by operating the VALUE push-button (4/6).

As soon as the leak rate drops below one of these thresholds, the corresponding LED (4/1), (4/2) or (4/3) will come on. At the same time, the corresponding relay contacts at the „CONTROL connection“ (3/12) are switched.

Changeover relay contacts at CONTROL (3/12):

Leak rate exceeds the trigger threshold level, relay inactive	Leak rate drops below the threshold level, relay active
<p>Trigger 1 Pins 5 and 6 are not linked. Pin 5 is linked to pin 7.</p> <p>Trigger 2 Pins 8 and 9 are not linked. Pin 8 is linked to pin 10.</p> <p>Trigger 3 Pins 11 and 12 are not linked. Pin 11 is linked to pin 13.</p>	<p>Pins 5 and 6 are linked. Pin 5 is not linked to pin 7.</p> <p>Pins 8 and 9 are linked. Pin 8 is not linked to pin 10.</p> <p>Pins 11 and 12 are linked. Pin 12 is not linked to pin 13.</p>

When the measurement mode is not active, the three triggers are set to the inactive state.

The three trigger also influence the automatic control of the gas ballast (see explanations for menu item 3).

Trigger 1 causes sounding of the acoustic warning signal provided „Alarm trigger ON“ has been selected in menu item 18 (see explanations for menu item 18).

If the relay mode 3 is selected in menu item 16, only the threshold values 1 and 2 are available.

Note

In the case of manual ranging (MANUAL push-button (4/11)) only trigger values which fall within the bargraph display range can be detected.

The trigger threshold level for Trigger 1 is adjusted as follows:

Press MENU push-button (4/7).

Pressing the upper (^) or the lower (v) symbol on the SCROLL push-button (4/5) selects the desired menu item 01. The display will indicate the following, for example:

01: Trigger 1 2.5E-10

Note

The flashing 1 indicates that trigger threshold 1 has been selected. The currently stored trigger threshold level is indicated to the right.

By pressing the VALUE push-button (4/6) one may select the desired trigger 1, 2 or 3.

If it is required to change the corresponding trigger level (numerical value), then you must press the ENTER push-button (4/8).

If the message „Keyboard locked“ is displayed when trying to change a parameter, this means that access to the keyboard has been restricted. The parameters for this trigger can not be changed in such a case. The keyboard may be unlocked by selecting menu item 14. Otherwise the display will indicate:

01: Trigger 1 2.5E-10

The factor (2.5) flashes and can be changed through the VALUE push-button as required. Acknowledge the change by pressing the ENTER push-button. The display will indicate the following, for example:

01: Trigger 1 4.3E-10

The exponent (-10) flashes and can be changed in the same way as described above. Pressing of the ENTER push-button acknowledges the changed exponent. Then display will then display the newly entered trigger threshold level.

01: Trigger 1 4.3E-9

The trigger threshold levels for triggers 2 and 3 may be changed in the same way.

02: Mode Vacuum *Select leak detection mode (vacuum, partial flow or sniffer leak detection)*

Vacuum stands for vacuum leak detection mode. Refer to Operating Instructions GA 10.211, Chapter „Vacuum leak detection“ for more information.

Sniff stands for sniffer leak detection. Here two different sniffing modes may be selected:

NORMAL: for the standard sniffer mode when using the sniffer line for the UL 200 (Cat. No. 140 21 or 140 24). These sniffer lines are particularly well suited for especially sensitive measurements and offer a short response time.

QT for the Quicktest sniffer. Sniffer leak detection in connection with the Quicktest QT 100 (Cat. No. 155 94) sniffer. This sniffer is particularly well suited in the case of long sniffer lines (5; 20; 50 m).

Part.flow for connection of an external LEYBOLD partial flow pump set (see Chapter 1.3.2). Here two partial flow modes may be selected.

Normal: Standard partial flow operating mode
Oil-free Avoids possibly occurring backstreaming of oil vapour from the partial flow pump.

Note

Switch off the FINE MODE lock (menu item 31) „Only GROSS mode off“.

03: Gas ballast closed *Remove helium background with the gas ballast facility*

The gas ballast is employed to reduce a helium background in the UL 200 which is too high. For this, the built in gas ballast valve of the forevacuum pump must be opened in the Standby mode („Gas ballast **OPEN**“).

After 20 minutes the valve closes automatically. But the gas ballast valve may also be closed manually by selecting „Gas ballast **CLOSED**“.

The gas ballast valve will also closed after having selected „START“ (start of the measurement process).

The gas ballast valve may also be opened automatically. This is done in the setting „Gas ballast **AUTO**“. Here the internal helium background is monitored for the first time after 30 s have elapsed in the Standby mode. If a helium background in excess of 1/10th of the entered trigger level for triggers 1, 2 or 3 is detected, the gas ballast valve on the forevacuum pump will open automatically. The gas ballast valve also opens automatically when the helium signal is so great that measurements in the most sensitive range are not possible.
($Q \sim 1E-6 \text{ mbar}\cdot\text{l}\cdot\text{s}^{-1}$)

The internal helium background can be displayed in the Standby mode through the function „21: System BG display“.

04: Test <enter> *Check the measurement signal for helium*

In this mode, the UL 200 checks whether or not the signal is generated by helium or by a high water vapour background, for example. For this, tuning of the mass spectrometer in the UL 200 is briefly shifted by 1/2 of a mass unit, i.e. it is adjusted to the masses 3.5 amu and 4.5 amu. The corresponding intensities which are then measured must reduce by at least 50 % compared to the measurement signal for mass 4.

The message „Test OK“ indicates that the measurement signal is being caused by helium.

The message „Test failed“ means that there is no clear peak on mass 4.

Possible causes:

- The sensitivity curve of a neighbouring mass, mass 2, for example, extends over to mass 4, superimposing this mass.
- There is no helium signal present (during Standby or Vent, for example).

The same applies correspondingly when the UL 200 has been set to $M = 2 \text{ amu}$ (H_2) or $M = 3 \text{ amu}$.

05: to 08: *not assigned*

09: Password locked *Enter password for access to the extended menu.*

See Chapter 2.5.2.

10: Evac Time 1 30 s *Monitoring of gross leaks.*

This menu item is used to define when the gross leak message is to occur. The gross leak detection process operates in two steps and the limits can be adapted as required.

This menu item is particularly useful in series testing under the same conditions at all times.

After pressing the Start push-button the test sample is evacuated. If the pressure conditions are not attained, or if the pressure does not drop low enough within the periods of time specified here, the pumpdown process is terminated and the display (4/2) will indicate one of the messages „EVAC Stopped Time 1“ or „EVAC Stopped Time 2“.

Within the period of Time 1, the inlet pressure at the test flange (3/2) must have dropped below 100 mbar. The duration may be selected freely between 1 second and 9 minutes or can be set to endless. The default is 30 s.

Within the period of Time 2 the status of measurement readiness must have been attained, i.e. the inlet pressure must have dropped below 2 mbar. The duration may be freely selected between 1 minute and 10 minutes or can be set to endless. The default is 10 minutes.

The periods which are selected in each case depend firstly on the desired reaction time for the gross leak message, and secondly on the volume of the test sample and the effective pumping speed.

Caution



If the evacuation time was set to endless the oil level of the mechanical pump should be checked more often.

11: Sensitivity normal *Select sensitivity*

normal: The output of leak rates to the hand unit and the control panel is restricted.

For both hand unit and control panel „-9“ is the lowest exponent for the unit $\text{mbar}\cdot\text{l}\cdot\text{s}^{-1}$. Software filtering is performed over 8 measured values at intervals of 20 ms.

high: The sensitivity of the leak detector is increased. The detection limit is $Q < 5\cdot 10^{-11} \text{ mbar}\cdot\text{l}\cdot\text{s}^{-1}$. The reaction time of the UL 200 is now longer since software filtering is performed over 512 measu-

red values at intervals of 20 ms, provided the most sensitive preamplifier area has been selected.

Switchover occurs at a leak rate of about $1 \cdot 10^{-6}$ mbar·l·s⁻¹. This kind of averaging also applies when determining the offset. The calibration factor is calculated with normal filtering.

Note

When manual ranging has been selected (MANUAL 4/8), the exponent „-10“ can be selected also in the „normal“ status.

The resolution limit also affects the display in the Stand-by mode.

12: Display LR + PE *Select information which is to be displayed on the LCD (4/2)*

Information is displayed on the LCD panel (4/2) during the measurements. One may select between three different information modes:

- LR + UNIT: Leak rate and unit are displayed.
- LR + PE: Leak rate and inlet pressure are displayed.
- PE + PV: Inlet pressure and forevacuum pressure are displayed.

13: Recorder LR *Select chart recorder function (3/11)*

In the extended menu it is possible to define the assignment of the chart recorder outputs. Depending on what is the selected the following assignments result:

a) Selected assignment: LR

Pin	Assignment
1	Leak rate mantissa U = 0.1 to 10 V for manual ranging U = 1 to 10 V for automatic ranging
2	GND, reference ground
3	GND, reference ground
4	Leak rate exponent (step function) U = 1 to 10 V; 0.5 V / decade starting at 1 V = $1 \cdot 10^{-12}$ mbar·l·s ⁻¹ / $1 \cdot 10^{-12}$ Pa m ³ ·s ⁻¹ .

Pin 1



Pin 4

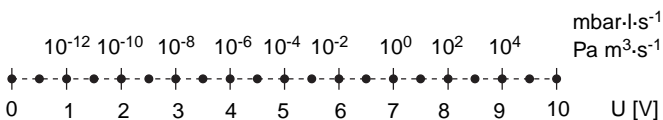

b) Selected assignment: LR + PE

Pin	Assignment
1	Leak rate, logarithmic U = 1 to 10 V; 0.5 V / decade starting at 1 V = $1 \cdot 10^{-12}$ mbar·l·s ⁻¹ / $1 \cdot 10^{-12}$ Pa m ³ ·s ⁻¹ .
2	GND, reference ground
3	GND, reference ground
4	Inlet pressure PE, logarithmic U = 1 to 10 V; 0.5 V / decade starting at 1 V = $1 \cdot 10^{-3}$ mbar / $1 \cdot 10^{-3}$ Pa.

Pin 1 LR

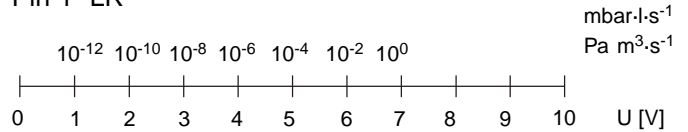

Pin 4 PE

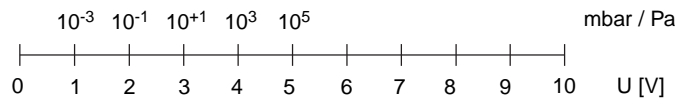

c) Selected assignment: PE + PV

Pin	Assignment
1	Inlet pressure PE, logarithmic U = 1 to 10 V; 0.5 V / decade starting at 1 V = $1 \cdot 10^{-3}$ mbar / $1 \cdot 10^{-3}$ Pa
2	GND, reference ground
3	GND, reference ground
4	Forevacuum pressure of the TMP PV, logarithmic U = 1 to 10 V; 0.5 V / decade starting at 1 V = $1 \cdot 10^{-3}$ mbar / $1 \cdot 10^{-3}$ Pa

Pin 1 PE

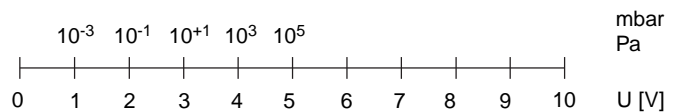

Pin 4 PV

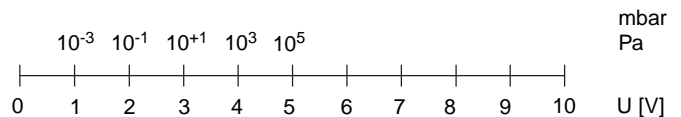

14: Control Keyboard 1 *Select control location / define locks*

The UL 200 may be controlled from 3 locations. Here it is possible to define which location is to control the UL 200.

Keyboard: The UL 200 is controlled by the hand unit (Fig. 4) and the control panel (Fig. 5). Access to the keyboard can be restricted in two levels.

Keyboard 1: The keyboard is fully operational. No restrictions for the hand unit or the control panel.

Keyboard 2: The CAL push-button (4/9) is locked. No changes can be made in the basic menu. Access to the extended menu as well as changes to the service menu are only possible after entering the passwords once more.

Keyboard 3: The push-button CAL, MANUAL and ZERO are locked. No changes can be made in the basic menu. Access to the extended menu as well as changes to the service menu can then only be made by entering the passwords once more. The UL 200 can only be controlled via the push-buttons START / STOP / VENT and volume control.

RS 232: A computer which is connected to SERIAL (2/10) socket controls the UL 200. All function keys on the hand unit and the control panel are locked. No changes can be made in the menus.

Ext. Inputs: The UL 200 is controlled via the CONTROL connections (3/12) Start, Stop and Zero. See Chapter 2.6.
The starting process is initiated by a rising edge at the corresponding input.
When a positive rising edge is applied to the STOP input, the measurement is stopped or an error is acknowledged.
Venting occurs when a logic level of „1“ is applied to the STOP input for a period of time which exceeds the time defined in menu item 22. In the same way as for the ZERO push-button (5/1) a constant background coming from the test sample may be suppressed via the CONTROL connection. When applying a logic signal 1 (high), the current leak rate is reset to Zero (suppression of the external helium background). When applying a logic signal 0 (low) (or when the ZERO input is left unused) the entire measurement signal will be displayed.

15:RS 232 Baud rate 9600 Parameter setting for the SERIAL connection (3/10) (refer also to the description for the interface SB 10.211).

16: Relay Mode 1 *Definition of the function output*

The function of the relay changeover contacts 11, 12, 13 or 14, 15 and 16 of the plug CONTROL (3/12) can be set by modifying the relay mode. 3 modes are available:

- Mode 1: Contacts 14, 15, 16 generate a ready signal
- Mode 2: Contacts 14, 15, 16 generate a fail signal
- Mode 3: Contacts 14, 15, 16 generate a ready signal
 Contacts 11, 12, 13 generate a fail signal

Note

In mode 3 the threshold value 3 is not available (see Chapter 2.5.4) the corresponding LED (4/4) is not controlled.

Instrument mode	Contact status / linked contacts	
	Mode 1 and 3: Ready	Mode 2: Fail (Mode 3: Fail)
UL 200 switched off	inactive/ Pin 14 and 16 closed	inactive/ Pin 14 and 16 (11 and 13) closed
UL 200 switched on	inactive/ Pin 14 and 16 closed	active / Pin 14 and 15 (11 and 12) closed
Standby	inactive/ Pin 14 and 16 closed	active / Pin 14 and 15 (11 and 12) closed
EVAC	inactive/ Pin 14 and 16 closed	active / Pin 14 and 15 (11 and 12) closed
Measurement mode	active / Pin 14 and 15 closed	active / Pin 14 and 15 (11 and 12) closed
Inlet vented, VENT	inactive/ Pin 14 and 16 closed	active / Pin 14 and 15 (11 and 12) closed
Calibration	inactive/ Pin 14 and 16 closed	active / Pin 14 and 15 (11 and 12) closed
Fault condition	inactive/ Pin 14 and 16 closed	inactive/ Pin 14 and 16 (11 and 13) closed
SERVICE (default)	inactive/ Pin 14 and 16 closed	active / Pin 14 and 15 (11 and 12) closed

18: Alarm Trigger off *Select acoustic warning*

The loudspeaker can output a signal which depends on the operating mode as described in the following.

off: The frequency of the acoustic output responds in the same way as the reading on the bargraph display (5/4). In this mode the presence of a leak can be localized very well without being able to see the UL 200 or the hand unit. The sound covers a range of appr. 300 Hz (underflow (5/5) indicator active) to appr. 3000 Hz (overflow indicator (5/7) active). When the reading on the bargraph (5/4) moves from the lower decade to the upper decade, a signal of f = 900 Hz is generated.

on: This operating mode is recommended when a passed/rejected statement is to be made.

The loudspeaker will be active if the leak rate falls - for the first time following the start procedure - below the threshold value 1. The activation is signalled by a short acoustic „Beep“.

As soon as the leak rate exceeds the trigger threshold of trigger 1 (see menu item 1) a frequency modulated signal is produced.

19: LCD Contrast 8 *Change contrast for the LCD text display line (4/2)*

The text display (4/2) on the UL 200 is of the liquid crystal type (LCD). This kind of display offers only a relatively limited optimum viewing angle. For this reason this menu item offers the possibility of being able to shift the optimum angle of view in the vertical direction.

21: System BG display off *Display / suppress helium background during Standby*

on: In the Standby or Vent mode the internal helium background of the UL 200 is displayed on the bargraph (5/4) of the hand unit and also on the control panel (4/2) (refer also to the description of the STOP push-button).

When running measurements for extended periods of time on samples where the leak rates are high, helium may accumulate in the leak detector. This helium background may be displayed via this menu function.

Note

The actual helium background may be up to $1.5 \cdot 10^{-9}$ mbar·l·s⁻¹ less than the displayed value.

off: In the Standby or Vent mode the detection limit is displayed on the bargraph display (5/4) of the hand unit and also on the control panel (4/2). During Standby the reading remains steady and constant.

22: Vent Delay 1.5s *Set venting delay time*

The push-button (5/2) on the hand unit, or CONTROL connection (3/12) pins 2 and 4 may be used to initiate two functions: STOP and VENT (see description of the STOP push-button). Through this menu item it is possible to define the delay time until the test connection is vented when operating the push-button or in the case of actuation via the control input.

0: The test connection of the UL 200 is vented immediately after operation of the push-button or actuation via the control input.

1; 1.5; 2: One of three delay times may be selected. When the push-button is pressed or the control input is actuated for a period of time which is shorter than the delay time specified here, the UL 200 will only change to the Standby mode.

When the push-button is pressed or the control input is actuated for a period of time which is longer than the delay time specified here, the UL 200 will vent the test connection and thus the connected sample.

No vent: No venting can be initiated by operating push-button (5/2) or via the control input (3/12). This setting is of particular advantage if inadvertent venting of the vacuum system is to be avoided.

23: System Integration off *Switch systems leak detection mode on / off*

off: This setting should be used during normal leak detection on components. The inlet area of the UL 200 and the connected test sample can be vented via the hand unit or by applying external signals (SERIAL or CONTROL). The test port (3/2) is vented when switching the UL 200 off.

on: When operating the UL 200 on an evacuated system, venting can be suppressed even in the case of a power failure or when inadvertently switching the UL 200 off. For this you must select the alternative „System integration on“. The setting which has been selected menu item 22 is overruled.

24: Request for CAL off *Automatic request for calibration*

Through this function the operator may be reminded of a necessary calibration.

on: The operator is reminded of the fact that a calibration has become necessary. The LCD display (4/2) will indicate the message „Request for CAL“. It is then left to the user to run the calibration or simply acknowledge the message by pressing the CLEAR push-button (4/10) and continue with the measurements. A request for calibration is issued when 1/2 hour has elapsed after having switched the instrument on or if the housing temperature in the preamplifier has changed by over 5 °C compared to the temperature during the most recent calibration.

off: The user is not reminded of the fact that a calibration has become necessary.

25: Mass 4 *Select mass*

Here the mass setting may be changed between 2, 3 or 4 amu. For helium you must select mass 4.

26: Date 09.Apr.96 *Set date and time*

Here date and time may be entered. If a printer is connected to the SERIAL socket, then the leak rates may be logged together with a date and time stamp. Moreover, date and time are used for logging of warnings, error messages and during the output of the status log (see service menu item 52 and 53).

27: Language *english* Set language
Choice between German, English, French or Italian language.

28: Power Frequency *50 Hz* Set mains frequency
Here the frequency of the mains power supply for the UL 200 must be entered.

The mains frequency has an effect on the effective pumping speed and also on the way in which the leak rates are calculated.

The mains frequency setting may be set to 50 Hz or 60 Hz.

29: Pumping speed *25 m³·h⁻¹*
Entry of the nominal pumping speed of the partial flow pump (from 4 - 80 m³·h⁻¹) at the set mains frequency.

30: Cal Leak *6.9E-7 mbar·l·s⁻¹* Entry of the value of the calibrated leak (*internal*)
In this menu item the leak rate of the built-in calibrated leak, can be read off or also changed.

The display of 0.0 E-07 means that the optional „internal calibrated leak“ has not been built-in. The entry range for this calibrated leak spans from 1.0 E-7 to 9.9 E-7 mbar·l·s⁻¹.

Note
The leak rate is **always** entered in mbar·l·s⁻¹.

31: Only GROSS off
When selecting the function „Only GROSS on“ the access to the FINE mode is locked. The leak detector remains in the GROSS mode with its valid specifications (Chapter 1.5.1)

Note
If the function „Only GROSS“ is switched on, oil vapours at low pressures can enter the vacuum lines of the leak detector and the test object.

32: ZERO-time *1 s* Entry of time constant for sliding zero
There are conditions at which the UL 200 may display „negativ“ leakrates, because the software subtracts internal and external background signals due to the Zero- und Autozero-function (please see chapter 2.4.4 and chapter 5). To avoid negative readings the stored background signals is updated. The ZERO-time adjustable between 0,5 s and 5 s defines the frequency of updates.

33: QUICK-Pump time *adjustment of sequences in partial flow mode*
The QUICK-Pump time T_Q is adjustable from 0 s to endless. T_Q defines whether and how long valve V 10 of the

partial flow valve block in opened (For detailed descriptions please refer to the operating instructions „GA 10.277“ of the partial flow pump system).

At $T_Q = 0$ s valve V 10 will not open for the time being. This selection is recommended for large volumes or dirty test objects.

At $T_Q = \infty$ (endless) valve V 10 will open when pressing START. At an inlet pressure $p_E < 3$ mbar the UL 200 switches to measurement mode and displays leak rates. $T_Q = \infty$ is recommended, if it is acceptable to wait for a while until measurement mode ($p_E < 3$ mbar) is reached and leak rate reading at high inlet pressures are not needed.

With times T_Q between 0 and endless V 10 is opened and the UL 200 tries to reach a inlet pressure of less than 3 mbar within this time T_Q . When T_Q has gone by V 10 is closed and the UL 200 switches to measurement mode (Helium inlet through the orifice of the partial flow valve block).

49: Change password 1 ? *Change password 1*
Access to the extended menu is protected by a password. If it is required to change this password you must first enter the old password according to the description given in Chapter 2.5.2 and then you must enter the password which is to be valid in future.

50: Password 2 locked *Permit changes in the service menu*
Through the service menu it is possible to make changes to the control system of the UL 200 and run test function.

The second password protects the service menus from being accessed inadvertently. The required password is only made available after corresponding training.

The second password remains valid (opened) until a password is entered with is not valid or until the instrument is switched off. After completion of any service work a password which is not valid should be entered or the instrument should be switched off.

Note
The second password restricts/enables access only to any **changes** which are made in the service menu, i.e. the user can access the service menu without having to enter the correct password as long he does not want to make any parameter changes.

51: 2.4 1400 D970000000 *Display software version number, catalogue number and serial number*
Display software version number, catalogue number and serial number.

In the case of failures or warranty claims, please state the serial number and the software version number of the instrument which are displayed here.

52: 01 E53 03.07.96 13:00 List error log

Outputs the 10 most recent error messages or warnings together with date and time.

Through the value push-buttons it is possible to call up the 10 most recent messages.

Since the number of digits of the text panel (4/2) is limited, only the number code 1 ... 99 of the error messages and warnings is indicated and error messages are marked by an „E“ whereas warnings are marked by a „W“.

A description for each error code number is given in the list of Chapter 4.2.

53: Status to RS232 <Enter> Output status report through RS 232

The status report provides important information on the internal conditions of the UL 200 for service work.

The status report may be output through a printer which is connected to the SERIAL connection (2/10) on the UL 200 or by using a computer running a terminal program (Windows TERMINAL, for example). How to connect a printer or a PC is described in the description of the interface SB 10.211.

54: Scan To Rec <Enter> Output mass spectrum

Via the chart recorder output (2/11) it is possible to output a mass spectrum for masses M2, M3 and M4.

Thus proper functioning of the detection system can be checked. You may connect either an X(t) or an XY chart recorder.

In order to be able to output the mass spectrum, you must first enter the second password (menu item 50) and switch of the automatic facility (menu item 70).

The preamplifier voltage is output through channel 1 [(2/11) pin 1 to pin 2]. The preamplifier voltage is output in a logarithmic manner.

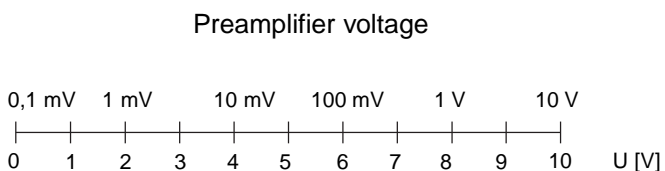

The mass spectrum can be run for each of the preamplifier's ranges (service menu 75).

The anode voltage which is required for selection of the mass is output through channel 2 [(2/11) pin 4 to pin 3] at a ratio of 1:100. The range of anode voltages which is swept ranges from 300 V to 1000 V (3 ... 10 V at the chart recorder output). Next, the anode voltage which has been stored for the selected mass is output.

The entire mass scan takes about 70 s.

Depending on the strength of the magnetic field of the built-in magnets, the peaks for the preamplifier voltages must fall into the following ranges:

- M2: 785 ... 995 V
- M3: 510 ... 670 V
- M4: 390 ... 520 V

How to proceed

Channel 1 is connected to the Y-input of the XY chart recorder or the voltage input of the X(t) chart recorder. When using an XY chart recorder you must also connect channel 2 to the X-input. Switch the chart recorder on and start the mass scan by pressing the ENTER push-button (3/8). When evaluating an X(t) recording you must take note of the fact that the anode voltage is increased by 5 V every 480 ms.

55: Value PE 1.2E+2 mbar Display (internal) measurement quantities

This menu item has been provided to indicate internal measurement quantities:

- PE Inlet pressure (1E-3 ... 1E+3 mbar)
- PV Forevacuum pressure (1E-3 ... 1E+3 mbar)
- Electronic Temperature on the electronics side in °C (10 ... 60 °C)
- Amplifier Preamplifier temperature in °C (10 ... 60 °C)
- TMP Turbomolecular pump frequency in Hz (1050 Hz)
- TMP status Status of the turbomolecular pump. 5 parameters are indicated, the status of which is indicated by 0 or 1. „0“ means OK, whereas „1“ indicates a fault condition. The status of the parameters is indicated from right to left: standard output of the converter, fail output of the converter, gate interrupt of the converter is missing, speed too low, speed too high.
- Anod-Cat Anode-Cathode voltage (30 V ... 130 V)
- Anode Anode voltage (M2: 785 ... 995 V, M3: 510 ... 670 V, M4: 390 ... 520 V)
- Suppressor Voltage at the suppressor of the ion collector
- Battery Battery voltage for date and time (U > 3 V)
- Rem.Cont. Supply voltage for the hand unit (U > 20 V)
- Ext. Supp. Voltage at the OPTION connection, pin 1, (20 V < U < 30 V)
- Reference Reference voltage (-10.02 V ... -10.44 V)
- Control Inp. Status of the 3 remote control inputs CONTROL (5/3) read from the left ZERO, STOP, START. „1“ means that the voltage at the corresponding connection exceeds 8 V.

56: Cycles V1 0012354 *Display valve cycle counter*
Here the number is displayed which indicates how often the valve has been opened. The desired valve may be selected through the Value push-button.

57: Operat. Time 111111h *Operating hours counter*
Displays the number of operating hours of the UL 200.

58: Task 00.00.00 *Display process status*
In the UL 200 several tasks are run in parallel. This menu item provides further servicing information.

59: Offset 00.000 V *Display characteristic quantities for leak rate calculations*

Offset Value of the offset in volts. As soon as the UL 200 has been running in the Standby mode for more than 20 s, the offset value is updated when changing from Standby to Measure. This offset value multiplied with the factor Fine produces as a result the internal helium background of the measurement system which is subtracted from the measurement signal during subsequent measurements. In the case of a clean measurement system this value must be less than 10 mV.

Factor Fine Calibration factor for vacuum leak detection ²⁾ (default: 7.265 E-13).

Factor G/F Sensitivity ratio between the vacuum ranges GROSS and FINE (1.000 ... 3.000). The ratio is defined in service menu item 92.

Factor Resistor True ratio of the most sensitive preamplifier resistors; see menu item 92 (30.00 ... 40.00). The factor is determined in service menu item 92.

Factor SN Calibration factor for standard sniffer leak detection²⁾ (default: 7.265E-13).

Factor SQT Calibration factor for Quicktest sniffer leak detection ²⁾ (default: 2.906E-10).

²⁾ The calibration factor is determined during an external calibration. The smaller the factor, the more sensitive the complete detection system of the UL 220 will be. The actual calibration factors may be by a factor of 2 greater or lower than the default value.

70: Automatic on *Switch automatic function on / off*

If changes are to be made to any of the automatically controlled functions, the automatic functions must be switched off first. This is required when wanting to make changes to the following service menu items:

54: Output of the mass spectrum

72: Manual operation of the valves / display valve status

75: Display preamplifier voltage / selection of the operating resistor

76: Selection of the post amplification factor / display of A/D converter voltage

First the second password has to be entered in service menu 50.

Caution When switching off the automatic functions, the built-in safety functions are partly disabled. Misoperation can lead to conditions where the leak detector may be impaired.

off: Autoranging, Autozero as well as fault and emission monitoring are switched off. The push-buttons CAL, START and STOP are disabled.

on: When the automatic function is switched on, the UL 200 will restart (warm boot).

71: Valve Supply Auto *Select valve supply voltage*

Auto: In order to reduce energy dissipation, valves V1, V2a, V4, V4.1, V6 and V7 are only briefly connected to the 24 V supply voltage (t = 200 ms) when actuated. Then the supply voltage drops to the holding level of U = 7.8 V.

High: The supply voltage remains at the 24 V level. The voltage is not reduced.

72: 12a2b3 V 4 *Display valve status*

Displayed to the right of the menu item number „72:“ on the LCD display (3/2) are those valves which are open at the moment. With the push-buttons VALUE and ENTER the valves may be opened and closed manually. However, before doing so, the automatic function must be switched off first (service menu item 70).

73: Emission On *Switch emission on / off*

When selecting this menu item, the current emission status is indicated first.

It is possible to switch the emission of the ion source on and off manually.

On: The emission is or has been switched on.

Off: The emission is switched off. The other supply voltages for the ion source remain switched on.

74: Anode M4 492V 10.000V *Run manual mass alignment*

Display anode voltage:

The anode voltage which corresponds to masses M2, M3 and M4 is displayed. Valid voltage ranges are:

M2: 785 ... 995 V

M3: 510 ... 670 V

M4: 390 ... 520 V

The mass number may be selected via the VALUE push-button.

Manual mass alignment:

As a rule, a mass alignment is run automatically during the calibration process. Through this menu item, the mass may be aligned manually.

For this a suitable calibrated leak (for example for M4: helium calibrated leak $10^{-8} \dots 10^{-6} \text{ mbar}\cdot\text{l}\cdot\text{s}^{-1}$) must be connected and the instrument must be running in the measurement mode. The correct password must be entered (service menu item 50) and the automatic function must be switched off (service menu item 70).

After the correct mass number has been selected, you must press the ENTER push-button (4/8).

The anode voltage flashes and can be changed via the VALUE push-buttons. At the same time the preamplifier voltage is monitored in the right-hand part of the LCD display (4/2) or on the bargraph display (5/4) of the hand unit. The anode voltage has been optimized as soon as the amplifier voltage has reached a maximum. The anode potential is stored in the EEPROM only when pressing the ENTER push-button once more and will thus be permanently available.

75: **Amp Emi 500G 10.000V** *Display preamplifier voltage*

Shown in this menu item is the preamplifier voltage. At the same time the current emission status as well as the selected preamplifier resistor is indicated.

The emission status can be changed and also the preamplifier range. The correct password must be entered (service menu item 50) and the automatic function must be switched off (service menu item 70). The status of the parameter has been changed only after pressing the Value push-button (4/6) and the Enter push-button (4/8) once.

Emi: Emission has been switched on.
off: Emission in Standby. No ionization takes place.
13M: Preamplifier resistor 13 M Ω
470M: Preamplifier resistor 470 M Ω
15G: Preamplifier resistor 15 G Ω
500G: Most sensitive preamplifier resistor 500 G Ω

76: **Gain A 16 2.5000V** *Display A/D converter voltage*

Shown in this menu is the current post amplification gain factor 0.25, 1, 4, 16 and the corresponding voltage of the analogue/digital converter. The voltage from the preamplifier is amplified by this factor and applied to the A/D converter. The A/D voltage lies in the range between 0 ... 2.5 V. The UL 200 selects the most favourable gain factor automatically. The four post amplification gain factors can be tested.

If, in the case of servicing, the post amplification factor is to be changed manually, the following conditions must be met first: enter the correct second password (service menu item 50), switch off the automatic function (service menu item 70). When running the service menu enter

„76: Gain M“ via the Value push-buttons and acknowledge by pressing the ENTER push-button. Then enter the required post amplification factor with the aid of the value push-buttons and the ENTER push-button. The corresponding A/D converter voltage can be read off in the right-hand part of the LCD display (4/2).

77: **Cathode 1** *Select cathode*

The ion source built into the UL 200 is equipped with 2 independent cathodes. Cathode 1 is used by default. The diode L4 (4/13) is green. When cathode 2 has been selected it is orange.

In the case of a failure the other cathode is selected automatically. A warning (W45 or W46) is issued when switching on the instrument. If a new ion source has been built in, the warning can only be erased after the corresponding cathode has been successfully switched on manually.

78: **Unit mbar·l·s⁻¹** *Select unit of measurement*

Switching between units.

When having selected $\text{mbar}\cdot\text{l}\cdot\text{s}^{-1}$ as the unit for the leak rates, the total pressure will be indicated in mbar.

When having selected $\text{Pa m}^3 \text{ s}^{-1}$ as the unit for the leak rates, the total pressure will be indicated in Pa (Pascal). Different hand units will be required depending on which unit has been selected.

79: **Default Reset <enter>** *Reset parameters to default*

All parameters of menu items 1, 2, 3, 9, 10 to 25, 27, 49 are reset to default.

The error log in service menu item 52 is deleted.

82: **CAL Leak Factor** 3.39

Gives the calculation factor between internal and external calibrated leak.

90: **Amp-Test <enter>** *Preamplifier test (amplifier test)*

When running the amplifier test it is possible to qualitatively check the operation of the measurement chain (suppressor signal, preamplifier, post amplifier and A/D converter). When switching on this test, a test signal is applied to the preamplifier so that at the output a square wave is produced which is symmetrical about 0 V or the offset voltage. The positive signal amplitude (about 0.6 V) can be read off on the LCD display.

The frequency is about 2 Hz. In this mode the emission is set to Standby and the preamplifier is switched to the most sensitive range (500 G Ω).

Before, the correct second password must have been entered (service menu item 50).

The AMP test is started by pressing the ENTER push-

button (4/8) whereas pressing of the CLEAR push-button (4/10) ends the AMP test. For accurate testing, the pre-amplifier signal should be displayed on an oscilloscope (BMEVS and EVS on the control assembly).

91: Burn In On <enter> *Burn in test*

Through this function it is possible to check the stability of the leak detector.

The UL 200 runs a repetitive sequence composed of Measuring (about 80 s), Stop (30 s) and Venting (10 s). If an internal calibrated leak is present, an internal calibration is run after each 5th run during the Stop phase. If logging of the leak rate on a printer has been selected in menu item 15, then the current leak rate is output to the SERIAL connection (2/10) at the end of each measurement phase.

The automatic function must be active for this test (service menu item 70).

This test may be terminated by pressing the CLEAR push-button (4/10).

The push-buttons START, STOP and CAL are disabled during this test.

92: Adjust Resistor *Auxiliary alignment functions*

After having exchanged the preamplifier, the vacuum gauges, the EEPROMs or after having made major modifications to the vacuum system, these functions will assist proper alignment of the UL 200.

Three functions are available here:

- Resistor (preamplifier alignment)
- GROSS/FINE (alignment of the two vacuum ranges) and
- Thermovac (alignment of atmospheric pressure reading).

Before, the correct second password (service menu item 50) must be entered. The automatic (menu item 70) must be switched on.

Resistor:

In the preamplifier, the most sensitive range may be adapted to the other ranges.

Connect a calibrated leak of $5E-7 \dots 9.9E-7$ mbar·l·s⁻¹ to the test port (2/2) and open it.

Start the measurement process by pressing START (4/3) and wait until the FINE vacuum range has been attained.

Select service menu item „92: Adjust Resistor“ and start by pressing the ENTER push-button (4/8). During the alignment process the message „Performing Adjust“ will be displayed. As soon as the alignment process has been completed, the LCD display will return to its initial state „92: Adjust Resistor“. The alignment value which has been calculated can be read off through service menu item „59: Factor Resistor“.

GROSS / FINE:

Sensitivities alignment in the GROSS and FINE vacuum ranges.

Connect a calibrated leak of $1E-7 \dots 9.9E-7$ mbar·l·s⁻¹ to the test port (2/2) and open it.

Start the measurement process by pressing START (4/3) and wait until the FINE vacuum range has been attained.

Select service menu item „92: Adjust GROSS / FINE“ and start by pressing the ENTER push-button (4/8).

At first the reminder „Connect calibrated leak <enter>“ will be displayed. When acknowledging this once more by pressing ENTER, the alignment process will begin. First the FINE and then the GROSS range is measured. In order to indicate what is happening, the LCD display indicates the message „Performing Adjust“.

After completion of the alignment process, the alignment factor which has been calculated is displayed for about 2 s. This factor may also be displayed through service menu item „59: Factor G/F“.

Thermovac:

Auxiliary function for alignment of the Thermovac gauges which measure PE and PV. These are aligned at atmospheric pressure. Alignment is performed through the 1 k Ω trim pot. on the I/O board.

The lower pot. is used to align the gauge for PE whereas the upper pot. is used to align the gauge for PV.

How to proceed:

1. Switch the UL 200 off.
2. Remove the electronics cover.
3. Unscrew the fuse F6 in the left chapter of the wiring backplane (Fig. 8).
4. Switch the instrument on and select the service mode.
5. Enter password 2 (service menu item 50).
6. Switch the automatic function off (service menu item 70).
7. Open valves V3 and V2b (service menu item 72); the gauges are vented.
8. Select menu item „92: Adjust Thermovac“ and acknowledge by pressing ENTER.
9. Adjust PE and PV to 8.67 V via the trim pots.
10. Switch the instrument off, insert fuse F6 and fit the electronics cover.

During the alignment process the push-buttons START, STOP and CAL are disabled.

The CLEAR push-button (4/10) terminates the alignment process.

99: Change Password 2 ? *Change password 2*

The second password protects the service menus against inadvertent changes.

If it is required to change this password you must first enter the old password according to the description

given in Chapter 2.5.2 and then you must enter the password which is to be valid in future.

2.6 Equipment Connections

The mechanical and electrical connections are located separately at the connector strips on the side of the instrument.

The mechanical connections serve the purpose of applying or removing gases. With the aid of the angled bracket which is supplied with the instrument, it is possible to easily connect plastic tubes (6 mm outside diameter and 4 mm inside diameter).

The connections have been assigned as follows (from top to bottom):

- Venting gas with silencer (3/4)
- Exhaust (3/5)
- Gas ballast connection (3/6)

The UL 200 is equipped with four different multi-pin connection sockets for the purpose of electrical communication:

- **SERIAL (3/10)**: RS 232 interface (25 pins) to control the UL 200 via a PC or for connecting a printer.
- **RECORD (3/11)**: Chart recorder output (4 pins), 2 channels, 0 to 10 V.
- **CONTROL (3/12)**: Inputs / outputs (16 pins) for access to the four relay contacts and to control the UL 200 by means of digital START / STOP signals.
- **OPTION (3/13)**: Connections for driving of Leybold accessories (8 pins) (partial flow valve, for example).

The option „Set of connection plugs“ (see Chapter 1.3.2) is recommended in order to provide the corresponding links for the connections RECORD, CONTROL and OPTION. Commercially available connectors may be used for the SERIAL link.

Note

The optional plugs which have been supplied, are not numbered since they will only fit into their corresponding sockets. **In each case, the lower contact pin carries the number „1“.**

The exact way in which the pins of these connectors have been assigned, is given in the following.

2.6.1 RS 232 C Interface (SERIAL)

This RS 232 C interface (3/10) is wired as data communication equipment (DCE) and permits the connection of a printer or a PC for monitoring and data logging. The connection is made through a 25 way sub-D socket. Refer also to the interface description SB 10.211.

2.6.2 Chart Recorder Outputs (RECORDER)

The RECORDER output (3/11) may be used to log the leak rate, the inlet pressure and the forevacuum pressure.

The measured values are output by way of an analogue signal in the range from 0 ... 10 V. Resolution is limited to 10 mV. The instrument which is connected here (X(t) chart recorder, for example) should have an input resistance of no less than 2.5 k Ω . The measured values are available through pins 1 and 4. The reference potential (GND) is available at pins 2 and 3. **The contacts are numbered from bottom to top.**

The mode of the RECORDER output may be selected in menu item 13 (see Chapter 2.4).

Note

The chart recorder outputs are electrically isolated from the other plugs. If, in spite of this, hum interference is apparent it is recommended to operate the UL 200 and the chart recorder from the same mains phase. If this is not possible, you must make sure that the frame ground of both instruments is kept at the same potential.

2.6.3 Control Inputs and Outputs (CONTROL)

Via this connection (3/12) it is possible to control and monitor the UL 200 from a central system controller. Via the relay changeover contacts the three triggers (menu item 1) and the mode (Ready / Fail) of the UL 200 (menu item 16) may be monitored. The maximum rating for the relay contacts is 60 V DC / 1A. Moreover, the functions of the START (5/3), STOP (5/2) and ZERO (5/1) push-buttons may alternatively be controlled by applying logic signals to the CONTROL connection (menu item 14). The level of the logic signals must not exceed 35 V.

For operation please refer to the description of the individual menu items (e.g. menu items 14, 16). All CONTROL connections are electrically isolated.

The contacts are numbered from bottom to top.

Pin	Assignment
1	Start, $U < 7 \text{ V} / I = 0 \text{ A}$ (logic state 0) $U > 13 \text{ V} / I = 7 \text{ mA}$ (logic state 1)
2	Stop, $U < 7 \text{ V} / I = 0 \text{ A}$ (logic state 0) $U > 13 \text{ V} / I = 7 \text{ mA}$ (logic state 1)
3	Zero, $U < 7 \text{ V} / I = 0 \text{ A}$ (logic state 0) $U > 13 \text{ V} / I = 7 \text{ mA}$ (logic state 1)
4	GND, reference potential for contacts 1, 2, 3
5,6,7	Relay for Trigger 1; (compare with menu item 01) 5 center contact; 6 normally open contact, 7 normally closed contact This relay is activated when the level drops

Pin	Assignment
	below the trigger threshold, i.e. center contact 5 is then connected to contact 6.
8,9,10	Relay for Trigger 2
11,12,13	Relay for Trigger 3
14,15,16	Relay for the signal: ready to measure respectively error (compare with manu item 16)

Note

The pin assignment for contacts 8 to 16 follows the same order as for pins 5 to 7.

2.6.4 Connection for Accessories (OPTION)

Contact pins 1 and 3 are fused with an 0.8 A slow-blow fuse. The amount of power which can be drawn is limited to 10 W.

The following accessories may be connected here:

- external venting valve
- external partial flow valve
- sniffer probe

Pin	Assignment
1	+24 V, constantly applied, power supply for the LEYBOLD partial flow valve or sniffer lines.
2	GND
3	+24 V, switched by the UL 200 for an external venting valve
4,5,6 7,8	These pins are used in connection with accessories.

The contacts are numbered from bottom to top.

2.7 Calibration

The UL 200 may be calibrated in all its operating modes. A difference is made between internal calibration and external calibration.

Internal calibration (also see Chapter 2.7.1) is run during Standby using the optionally built-in calibrated leak for helium (must be present) and with the inlet valve closed.

External calibration (see also Chapter 2.7.2 and 2.7.3) requires an additional separate calibrated leak. Under certain circumstances external calibrations offer the advantage that these may be performed under conditions which resemble the conditions during the measurements more closely.

Note

- During initial start-up and before running the first calibration, the valid mains frequency /see Chapter 2.5 / menu item 26) should be entered.
- If the UL 200 is connected to a vacuum system, the calibrated leak must be connected to a point on the vacuum system which is as far away from the inlet as possible when running an external calibration. It will then also be possible to determine the response time.

In the case of systems leak detection, the influences of the pressure within the test samples and the pressure conditions in the partial flow mode of operation must be taken into account. In the case of sniffer leak detection, the distance between the tip of the sniffer and the test object and the velocity at which the tip of the sniffer is moving must be taken into account. Therefore, the method of external calibration is recommended in the case of systems leak detection (menu item 2: Mode P.Flow) and also in the case of sniffing (menu item 2: Mode Sniff).

A voltage which is supplied by the detection system and a calibration factor are used by the control computer to calculate the leak rate. Independent calibration factors are stored for the sniffer mode and the vacuum mode. Thus it will not be required to recalibrate when changing the operating mode (sniffer mode, vacuum mode) provided both operating modes have been calibrated beforehand.

2.7.1 Internal Calibration

For leak detection on components a calibration is normally started using the optionally built-in calibrated leak by pressing the CAL push-button (see Chapter 2.4.3 - Description of the CAL push-button). If the no internal calibrated leak has been built-in, an external calibration will have to be run. The internal calibration can only be run while the UL 200 is running in the Standby or Vent mode. Then the UL 200 will control everything else automatically, this being:

- Mass alignment
- Measurement of the calibrated leak
- Zero measurement
- Calculation of the calibration factor

The calibration process takes about 25 s and has been completed when the message „Calibration complete“ appears on the LCD display (4/2) and when an acoustic signal can be heard.

The calibration process can be terminated by pressing the CLEAR push-button (4/10) or by operating the CAL push-button (4/9) once more. Depending on the operating mode - vacuum or sniffer leak detection - the calibration factor „Factor Fine“ or „Factor Sniff N/QT“ is changed.

Note for sniffer mode N and QT

During the internal calibration process, the internal sensitivity of the UL 200 is calibrated. The calculated number is multiplied by the standard factor of 400 for Quick-test operation and 1 for standard sniffer operation and the result represents the calibration factor for the sniffer mode.

2.7.2 External Calibration

In the case of a calibration with an external calibrated leak, the external calibrated leak is attached to the test sample on the system or directly to the test port (3/2).

The use of calibrated leaks is permissible which produce a reading in the range from $5 \cdot 10^{-9}$ to $9.9 \cdot 10^{-4}$ mbar·l·s⁻¹.

Note

In the case of external calibration on systems where the pumping speed of the pump system is high, the circumstances may be such that a calibrated leak can not be detected owing to the high partial flow factor. In such cases a calibrated leak with a higher leak rate must be used.

For external calibration it is required that the UL 200 is running in the measurement mode.

Select the measurement mode by pressing the START push-button, for example.

When the green light emitting diode on the hand unit (5/3) is on continuously, or when the LCD display indicates a measured value, then press the CAL push-button (4/9).

The running process may be terminated by pressing the CLEAR push-button (4/10) or by pressing the CAL push-button (4/9) once more. In contrast to the fully automatic internal calibration process, the external calibration process is interactive. After it has been started, the LCD display (4/2) will indicate messages which inform the operator about the process and ask him to run further operations.

Displayed message (4/2)	Action required by the operator
Autotune	none
Open Cal-Leak <enter>	Open the calibrated leak and acknowledge by pressing ENTER.
Cal-Leak: (z.B.) <u>3.5</u> E-07 mbar·l·s ⁻¹	Enter the value of the mantissa and acknowledge by pressing ENTER.
Cal-Leak: 3.5 E- <u>07</u> mbar·l·s ⁻¹	Enter the exponent and acknowledge by pressing ENTER.
Signal Stable ? <enter>	Wait until the readout (5/4) is stable and then press ENTER.
Performing mass alignment Acoustic signal after completion	none
Close Cal-Leak <enter>	Close the calibrated leak and then press ENTER.
Signal Stable <enter>	Wait until the readout (5/4) is stable and then press ENTER.
Calibration finished	The measurement may now be continued.

The calibration factor is calculated on the basis of a two-point measurement (open calibrated leak and closed calibrated leak).

Note

For proper determination of the calibration factor a minimum difference between open and closed leak is required. If this difference is too small then the error message „E78: CAL difference too small“ will appear. In such a case use a larger calibrated leak.

Depending on the operating mode - vacuum or sniffer leak detection - the calibration factor „Factor Fine“ or „Factor Sniff N/QT“ is changed.

If the calibration is run in the partial flow mode where the partial flow valve is open, then the calibration factor „Factor F/P“ (see description for menu item 59) is changed.

2.7.3 External Calibration for Sniffer Applications

For sniffer applications, the UL 200 should be calibrated externally. For this it is required that the UL 200 is running in the measurement mode and that a sniffer has been connected to the test port (3/2). The instrument must be running in the sniffer mode „2: Mode Sniff NORMAL“ or „2: Mode Sniff QT“.

Enter the measurement mode by operating the START push-button, for example.

When the green light emitting diode on the hand unit (5/3) is on continuously, or when the LCD display (4/2) indicates a measured value, then press the CAL push-button (4/9).

The running process may be terminated by pressing the CLEAR push-button (4/10) or by pressing the CAL push-button (4/9) once more. After it has been started, the LCD display (4/2) will indicate messages which inform the operator about the process and ask him to run further operations as above.

For calibration of the helium leak rate, a sniffer calibrated leak (e.g. Cat. No. 155 88, TL 4-6) is required. However, also a sample of a leaky component which is filled with helium where the leak rate is known may be used as a reference leak. After having entered the nominal leak rate and after having unscrewed the blocking valve on the leak (the opening of the leak is directly accessible) proceed in the same way as described in Chapter 2.7.2 „External Calibration“ but with the following exceptions:

- When the message „Open Test Leak < enter>“ is displayed, the tip of the sniffer must be held as closely as possible in front of the external leak instead of opening it.
- When the message „Close Cal-Leak <enter>“ is displayed, the tip of the sniffer must be held in uncontaminated ambient air, i.e. no helium may be sprayed around in the vicinity.

2.8 Shutdown

To shut down the UL 200, set the mains ON / OFF mains switch (2/7) to the „0“ position regardless of the operating mode the UL 200 is currently running. Nothing else is required. When switching off the instrument it is vented as is the test sample too.

Note

If venting of the test sample or the system is to be prevented when switching the instrument off you should select in menu item 23: System integration „ON“ before doing so.

The operating mode of the UL 200 and all other parameters are saved. After switching the instrument on again it will resume operation in the same mode.

3 Maintenance

3.1 LEYBOLD Service

If equipment is returned to LEYBOLD, indicate whether the equipment free of substances damaging to health or whether it is contaminated. If it is contaminated also indicate the nature of the hazard. For this you must use a form which has been prepared by us which we will provide upon request or you may copy the form which has been reproduced on the next to the last page of this handbook.

Please attach this form to the equipment or enclose it with the equipment.

This „Declaration of Contamination“ is required to meet German Law and to protect our personnel. Leybold must return any equipment without a „Declaration of Contamination“ to the sender's address.

Before shipping, fit the yellow screw-on seals on to the connections EXHAUST (3/5) and GAS BALLAST (3/6) (see Chapter 2.1.2).

3.2 Maintenance Plan

Maintenance work should be done on the UL 200 as required. This work will normally be limited to exchanging the oil in the D 2,5 E rotary vane pump and the built-in air filters.

As a preventive measure it is recommended that you check the rotary vane pump once a month. Here note should be taken of the oil level and the colour of the oil. For details on this please refer to the Operating Instructions GA 01.600 for the TRIVAC D 2,5 E which have been enclosed.

Caution Only Arctic oil (Cat. No. 200 28 191) must be used in the TRIVAC D 2,5 E in the UL 200.

The monthly interval for the check is just a nominal period. If the leak detector is used heavily, in particular in the sniffer mode, then this check should be performed more frequently. The rotary vane pump is located on the side of the mechanical section at the bottom of the leak detector.

3.2.1 Opening the UL 200

Switch the UL 200 off.



Pull the mains cord on the UL 200.

Remove the cover (6/8) for the mechanical section. Separate the UL 200 from other vacuum components at the test port (6/2).

Turn the UL 200 so that it is orientated in the same way as shown in Fig. 6.

Key to Fig. 6

- 1 Hand unit
- 2 Test port
- 3 Cover for the electronics section
- 4 VENT input
- 5 Connection for the exhaust line
- 6 Gas ballast connection
- 7 Mains switch with mains fuses
- 8 Cover for the mechanical section
- 9 Openings for removal of the cover for the mechanical section
- 10 Four screws for loosening the cover for the electronics section

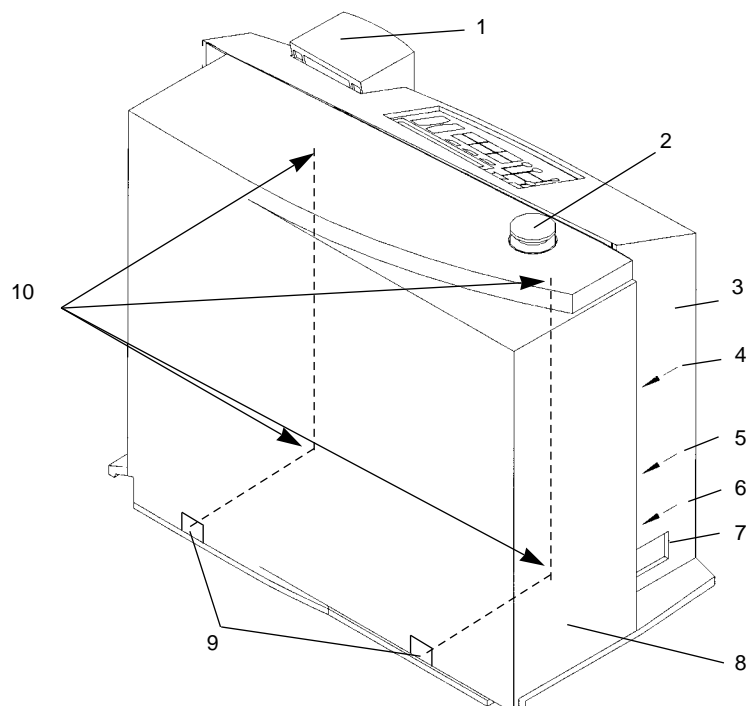

Fig. 6 View of the mechanical side

Use two flat blade screwdrivers and insert these into the openings (6/9) and lever the cover for the mechanical section out at the bottom.

In doing so, the cover should at first be moved somewhat to the front by the downward motion of the screwdrivers (7/1). Then cover may be lifted up by the upwards motion (7/2) of the screwdrivers so that the cover is disengaged completely.

Then pull the cover off the mechanical section up to its stop and remove it to the front.

After completion of all maintenance work the cover of the mechanical section (6/8) must engage properly in the openings (6/9) at the bottom.

Removing the cover (6/3) for the electronics section.

Detach the hand unit (6/1). Pull the cable for the hand unit out of its container on the UL 200.

Remove the cover for the mechanical section (6/8) as described above.

Remove the four Phillips screws (6/10).

Pull the cover of the electronics section (6/7) back to the rear and place it aside.

3.2.2 Exchanging the Filter Mats

The filter mats have been built-in to filter the dust out of the air which is taken in. In order to ensure that the filter mats will not throttle the air flow and so that sufficient cooling is possible at all times, the filter mats should be cleaned or exchanged as soon as these have attained a dark grey colour.

Filter mats are used at three places within the UL 200.

- a.) at the ventilation slit behind the attached hand unit (only partly visible from the outside)
- b.) on the face side to the back (only partly visible from the outside)
- c.) at the fan of the turbomolecular pump (not visible from the outside).

To exchange the filter mats remove the covers (see Chapter 3.2.1).

Filter mat a.) This filter mat is attached to the cover of the electronics section by means of a metal grid. Unscrew the grid and exchange the filter mat.

Filter mat b.) This filter mat is located on the side together with a further metal grid in a recess. It can be exchanged without having to use any tools.

Filter mat c.) This filter mat is fixed in place by the fan of the turbomolecular pump. Unscrew the two screws which attach the fan and exchange the filter mat.

Under certain circumstances a dirty mat may be cleaned by shaking the dust out or by using a vacuum cleaner so that the filter mat may be reused.

3.2.3 Exchanging the Oil

Remove the cover of the mechanical section (2/8) as described in Chapter 3.2.1.

Warning



Before starting with any disassembly work on the pumps, pull the mains plug first. When the pump has been pumping hazardous substances, determined the kind of hazard first and ensure that suitable safety precautions are taken.



Observe all safety regulations!

Caution



When disposing of waste oil you must observe the applicable regulations for the safety of the environment!

The type of maintenance work and the maintenance intervals as well as the oil change procedure are described in the corresponding Operating Instructions and

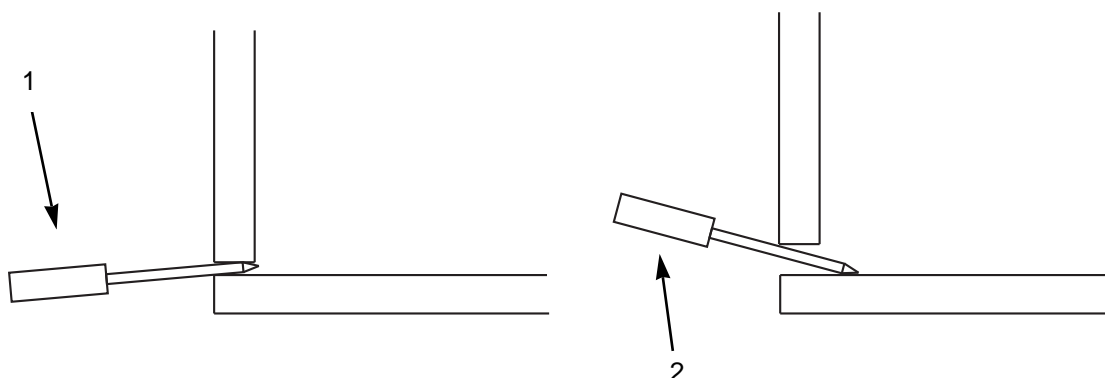

Fig. 7 Disengaging the cover of the mechanical section

these must be followed closely.

As already stated in Chapter 3.2 only Arctic oil must be used for the D 2,5 E pump in the UL 200.

Fit the cover for the mechanical section (6/8).

3.2.4 Cleaning

The housing of the UL 200 is made of painted plastic parts. Thus for the purpose of cleaning, only such agents should be used which are generally also used for other painted or plastic surfaces (mild household cleaning agents, for example). Normally a moistened piece of cloth will do. Never use any solvents which are capable of dissolving paint (like acetone, toluol, etc.).

A soft brush or a vacuum cleaner is recommended for cleaning the ventilation slits.

3.2.5 Exchanging the Fuses

Warning Before exchanging the fuses you must disconnect the mains cord.



Switch the UL 200 off.

Pull the mains cord on the UL 200.

Use a screwdriver to fold out the lid of the mains socket (3/7) from the right (the mains switch is not affected by this).

The fuses can be removed by pulling the drawers out which are marked by the arrows. When reinserting these make sure that the arrows point downwards.

In any case two fuses of the same rating must be inserted. The required mains fuses are:

- T 3.15 A slow-blow (20 x 5 mm dia.) for the 230 V model.
- T 6.3 A slow-blow (20 x 5 mm dia.) for the 100 / 110 V model.

After having exchanged the fuse(s) press the lid of the mains socket firmly back on.

Insert the mains cord into the UL 200 and switch the instrument on.

Besides these mains fuses several internal circuits are fused separately. These fuses are listed in the following table. See also Fig. 8.

In order to exchange these fuses you must proceed as follows:

- Switch the UL 200 off.
- Pull the mains cord on the UL 200.
- Remove the cover for the mechanical section (6/8) and the cover for the electronics section (6/3) according to Chapter 3.2.1.

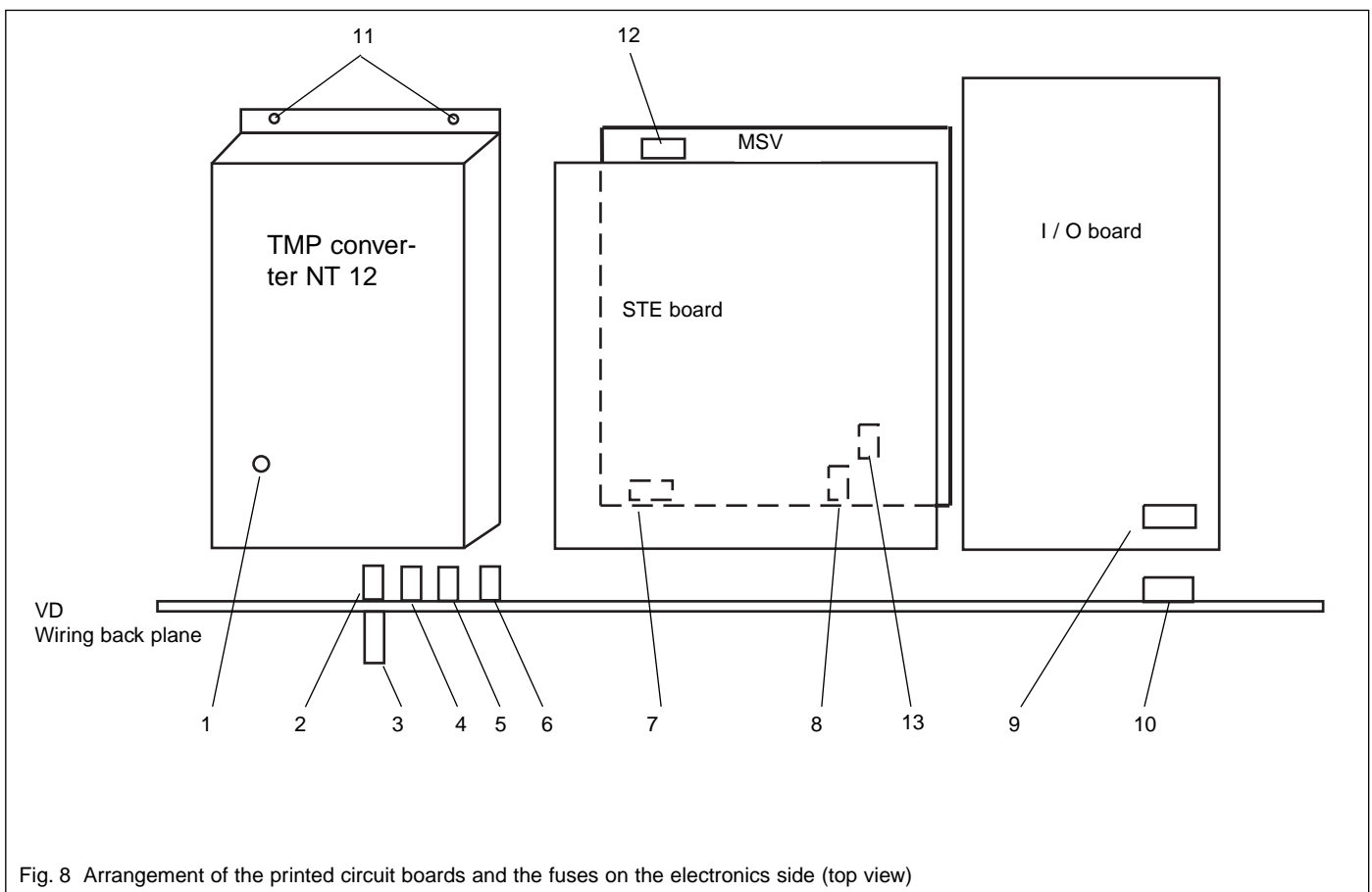

No in Fig. 8	Designation	Fuse rating	Remark	No in Fig. 8	Designation	Fuse rating	Remark
1	F1 in NT 12	1 AT	Protects the electronics which drive the turbomolecular pump. Pull the electronics which drive the turbomolecular pump out to the top. For this loosen screws (8/11). Unscrew fuse F1.	8	F2 on MSV	2AT	24 V system voltage of the mass spectrometer supply. Loosen control panel (Fig. 4) (two Phillips screws). Loosen the panel which holds the MSV board in place (two Phillips screws). Pull the MSV board up to the top. For this insert a screwdriver into two the recesses at the sides (top) one after the other and lever the MSV board out by resting the screwdriver on the STE board.
2	F5 on VD	0.032AT	Protects „TMP-Fail“ signal. Pull the electronics which drive the turbomolecular pump out to the top. For this loosen screws (8/11).	9	F1 on I/O board	0.8AT	Protects the 24 V supply carried by the OPTION socket (3/13).
3	F6	6.3AT	For protection of the forevacuum pump and the turbomolecular pump.	10	F1 on MB	0.8AT	Supply voltage for the hand unit.
4	F4	0.032AT	Protects „TMP Normal“ signal. Pull the electronics which drive the turbomolecular pump out to the top. For this loosen screws (8/11).	11	--	--	--
5	F2	0.032AT	Protects „TMP Gate“ signal. Pull the electronics which drive the turbomolecular pump out to the top. For this loosen screws (8/11).	12	F3 on MSV	1 AT	For generating + 5 V and ± 15 V
6	F3	0.032AT	Protects „TMP Frequency“ signal. Pull the electronics which drive the turbomolecular pump out to the top. For this loosen screws (8/11).	13	F4 on MSV	0.032 AMT	Fuses for the anode and cathode voltages
7	F1 on MSV	2AT	24 V system voltage of the mass spectrometer supply. Loosen control panel (Fig. 4) (two Phillips screws). Loosen the panel which holds the MSV board in place (two Phillips screws). Pull the MSV board (the board at the back) up to the top. For this insert a screwdriver into two the recesses at the sides (top) one after the other and lever the MSV board out by resting the screwdriver on the STE board.	<p>As can be seen in Fig. 8, Fuse 1 in the NT 12 frequency converter.</p> <p>Fuses 2, 4, 5, 6 are located on the wiring backplane under the NT 12 frequency converter.</p> <p>Fuse 3 is located beneath the wiring backplane.</p> <p>Fuses 7 and 8 are located on the MSV board.</p> <p>Fuse 9 is located on the I/O board.</p> <p>Fuse 10 is located on the wiring backplane under the I/O board.</p> <p>Finally re-install the covers for the electronics section and the mechanical section in the reverse order.</p>			

4 Messages

During leak detection operations, the LCD display (3/2) will indicate information which supports the operator operating the UL 200. Besides measurement data also current equipment conditions, operating hints as well as warnings and error messages can be displayed.

4.1 Equipment Messages

All messages are listed in the following table in alphabetical order.

LCD text display	Meaning
Abort with <Clear>	Function can be terminated by pressing the „CLEAR“ push-button.
Are you sure ? <enter>	Is this function to be continued? Continue by pressing the ENTER push-button (4/8). The function can be terminated with „CLEAR“.
Cal-Leak: x.xE-xxmbarl/s	The value of the external calibrated leak can be entered.
Calibration finished	The calibration process has finished.
Calibration stopped	The calibration process has been stopped.
Close Cal-Leak <enter> ,	The external calibrated leak should now be closed. Continue by pressing the ENTER push-button (4/8).
Connect Testleak <enter>	Connect the external calibrated leak to the test port (3/2) or the test sample, open calibrated leak.
Emission OFF ==> ON	The emission of the mass spectrometer (MS) is off and will now be switched on. The corresponding LED L4 (4/13) on the control panel flashes.
Evacuation PE=x.xE-x	The test sample connected to the test port (3/2) is pumped down. The inlet pressure is displayed.
GROSS/FINE = x.xxx	The GROSS/FINE conversion factor is displayed.
Invalid Key	Operation of this push-button is not allowed in this mode.
Keyboard locked	The keyboard has been locked. If required, unlock through menu item 14. The ZERO function is accessed via the OPTIONS socket (sniffer line, for example).

LCD text display	Meaning
LEYBOLD INFICON	First message to appear after the instrument has been switched on.
LR = x.xE-xx mbar-l/s	Indication of the leak rate in the unit mbar-l-s ⁻¹ .
LR = x.xE-xx Pa m ³ /s	Indication of the leak rate in the unit Pa Pa m ³ /s.
LR=x.xE-xx PE=x.xE-x	Simultaneous display of leak rate and inlet pressure in the unit which has been selected (menu item 12).
No Cal in Menu	Calibration can not be called up as long as the menu is open. First exit the menu by operating the MENU push-button (4/7).
No Gasballast allowed	The gas ballast valve can only be opened in the Standby mode. Operate STOP push-button (5/2).
No Int. Cal-Leak	Internal calibration can not be run. Either a calibrated leak has not been built in or its value has not been entered (service menu item 81).
No Menu in Cal	A calibration is running at the moment. The menu can not be selected. Terminate the calibration process or cancel it by pressing the CLEAR push-button (4/10).
No Zero in CAL	During calibration the ZERO push-button is disabled. Terminate the calibration process or cancel it by pressing the CLEAR push-button (4/10).
No Zero in Standby	The ZERO function can not be run in the Standby mode.
No Zero in Vent	The ZERO function can not be run in the Vent mode.
Open Cal-Leak <enter>	Open the externally fitted calibrated leak and continue the calibration process by pressing the ENTER push-button (4/8).
Password 1 changed	The password has been successfully changed.
Password 2 changed	The password has been successfully changed.
Password 1 locked	The first password has not been entered. Access to the extended menu (menu lines 10 to 49) is restricted. The default password is 0013.
Password 2 locked	Access to the service menu item has been restricted and no changes can be made.

LCD text display		Meaning	LCD text display		Meaning
		The correct password must be entered in service menu item 50 first.	Performing Standby		After having switched on the automatic functions (serv. menu item 70), the UL 200 performs a warm boot and then enters the Standby mode.
Password failed		The wrong password has been entered. The default password 1 is „0013“.	Performing Status RS 232		A status log is output to the SERIAL connection.
Password ok		The password has been entered correctly. The extended menu (password 1) is now accessible or changes can now be made in the service menu.	Performing Test		Function of menu item 4 is active.
PE=x.xE-x	PV=x.xE-x	Display of inlet and forevacuum pressure in the previously selected unit (menu item 12).	Running Up TMP:xxxxHz		The speed of the turbomolecular pump is indicated during run-up.
PE=xx.xxV	PV=xx.xxV	Display of sensor bridge voltage for inlet and forevacuum pressure. In the vented state (V3 and V2b open) a voltage of 8.67 V must be displayed. In the case of greater deviations (± 100 mV) an alignment should be run (see explanations for service menu item 92).	Signal Stable ? <enter>		The leak rate signal which is indicated on the bargraph display (5/4) must be stable. Then the calibration may be continued by pressing the ENTER push-button (4/8).
Performing Adjust		Running of service menu item 92. Function can be terminated by operating the „CLEAR“ push-button (4/10).	Sniff x.xE-xx mbar-l/s		The instrument is running in the sniffer mode (menu item 2) and the measured leak rate is displayed.
Performing Autotune		During the calibration process, the anode voltage of the detection system is changed so that the correct mass position is used. Function can be terminated by operating the „CLEAR“ push-button (4/10).	Standby		The Standby mode has been attained.
Performing Burn In		Continuous test in the sequence START, STOP, VENT (service menu item 91) is running. Function can be terminated by operating the „CLEAR“ push-button (4/10).	Switch off Automatic		This service menu item can only be changed after having switched off the automatic function (service menu item 70).
Performing CAL intern		A calibration is being run with the internal calibrated leak. Function can be terminated by operating the „CLEAR“ push-button (4/10).	Switch off Pump		Both forevacuum pump and turbomolecular pump must be switched off when aligning the Thermovac gauge. See description for service menu item 92.
Performing Mass Scan		A mass spectrum is output to the RECORDER output. Duration 70 s approx. Function can be terminated by operating the „CLEAR“ push-button (4/10).	Test failed		Result of the mass test function of menu item 4. No helium signal is measured. The helium signal is lost in the signals from mass 2 or mass 3.
Performing Offset		Determination of the helium background after the gas ballast valve has been closed.	Test ok		Result of the mass test function of menu item 4. The measurement signal is generated by helium (mass 4).
			UL 200 Version		Display of instrument designation and software version number when switching the instrument on.
			Updating Parameter		A parameter which remains permanently stored in the case of mains failures has been changed and stored.
			Vent		Vent mode, test connection (3/2) is vented. An optionally connected venting valve (OPTION) is activated.

4.2 Warnings and Error Messages

The UL 200 is equipped with comprehensive self-diagnostic facilities. When a fault condition has been sensed by the control board, this condition is indicated to the operator via the LCD display (4/2) as far as possible. Basically a difference is made between warnings and error messages.

4.2.1 Warnings

Warnings are indicated

- when the measurement process has been interrupted and when the UL 200 has been able to continue on its own without user intervention (for example when cathode 1 is faulty the UL 200 automatically switches over to cathode 2).
- when external influences impair the measurements (for example an air inrush will cause the UL 200 to revert to the Standby mode).

The UL 200 will indicate a message on the display („W21: xxxxxxxx“) and will remain in the Standby or the measurement mode.

Warnings remain displayed until they are acknowledged by pressing CLEAR or via a signal at the CONTROL connection (see menu 14). Warnings are logged and can be also be displayed at a later date through service menu item 52.

4.2.2 Error Messages

Errors are events which force the UL 200 to interrupt its measurement operations whereby the UL 200 is not able to continue on its own. Errors are logged, and can be also be displayed at a later date through service menu item 52.

The UL 200 remains in the error status described in the following. After the fault cause has been removed the error can be acknowledged by pressing the CLEAR push-button (4/10) or via the CONTROL connection (menu 14): The UL 200 then reverts to Standby.

Instrument status / instrument response in the case of errors:

Hand unit Fig. 5:

All LEDs on the hand unit flash. As far as the error is related to the hand unit the error code will also be displayed in the exponent display (5/9). START and STOP push-buttons are disabled.

Control panel Fig. 4:

The trigger status displays (4/1), (4/3) and (4/4) are off. The error information is indicated by the LCD display whereby an unambiguous error cause has been assigned to each error condition (e.g. „E21: ...“).

In the case of several errors, the individual errors are displayed cyclically for 2 s each.

Loudspeaker:

A frequency variable signal can be heard through the loudspeaker. The frequency changes every 400 ms from 500 to 1200 Hz so that this signal stands out well from any ambient noises normally encountered, and it can also be heard very well around the instrument.

RECORDER connection (3/11):

A voltage of 0 V is output through channels 1 and 2 of the analogue outputs. This voltage is not attained during normal operation.

CONTROL connection (3/12)

Function	Contact closed	Contact open
Trigger 1	5, 7	5, 6
Trigger 2	8, 10	8, 9
Trigger 3 / Fail	11, 13	11, 12
Ready/Fail	14, 16	14, 15

Note

During a fault valve 2a is open. All other valves (except the exhaust valve) are closed. Detection system and test flange are separated. The emission is switched off depending on the nature of the fault.

System errors are errors which occur in the control electronics and indicate the presence of a fault in the control assembly or in the operation of the instrument. Due to the nature of the fault, the information which can be provided is limited and incomplete.

The errors are mostly detected during initialization of the UL 200. Logging is not possible. The instrument can not be operated. Errors which are marked by a number between 10 ... 19 belong to this category of errors.

Note

Under extreme conditions (unknown software errors, excessively high electromagnetic interference levels) the built-in „watchdog“ circuit will prevent uncontrolled operation of the UL 200. This watchdog will cause the UL 200 to restart. After having done so, the instrument will be running in the Standby mode. No error message will be output.

Caution

In case of enquiries please keep the serial number and the software version number of the instrument at hand (service menu item 51).

4.2.3 List of all Warnings and Error Messages

Each message is composed of three parts:

The first letter of the message (E or W) indicates whether this message is an error message or a warning message. This letter is followed by a two-digit number and then the actual abbreviated message is displayed.

Listed in the following are all messages together with a brief explanation as to what has caused this message and what measures can be introduced.

Any abbreviations used in this list which may not be quite so familiar are explained at the end of this list.

Hardware problems are covered by messages 01 to 61, application-related problems by messages 71 to 81 and software problems by messages 84 to 93.

Hardware Problems

Note

The first 17 error messages will possibly not be displayed in the way they are described. For this reason these error messages are given in brackets.

E01: (FB-RAM)

RAM test for the hand unit (Fig. 5) has failed; exchange the hand unit (Fig. 5).

E02: (FB-ROM)

ROM test for the hand unit (Fig. 5) has failed; exchange the hand unit (Fig. 5).

E03: (FB-No Communication) during self test only

No communication during the self test.
Hand unit (Fig. 5) or interface component is faulty.

E04: (FB-Watch-Dog)

Watchdog in the hand unit has sensed something wrong.
Hand unit is faulty.

E05: (FB-Communication)

There is no communication. The hand unit is not receiving any data from the control board.
Interface component on the control board is faulty.
Interface component in the hand unit (Fig. 5) is faulty.

E10: (GB-Failed)

Busy flag on the control panel has not been reset.
Exchange control panel (Fig. 4).

E11: (STE RAM failed)

Write/read test has failed during initialization.
Control board faulty.

E12: (STE ROM failed)

An incorrect checksum has been determined.
Control board faulty.

E13: (STE EEPROM failed)

- Acknowledgement signal ACK has not been received.
- Write/read test has failed during initialization.
EEPROM faulty.

E14: (STE Real-time Clock failed)

- Time and data information does not make any sense.
- Clock has stopped or control board is faulty.

E15: (STE Recorder failed)

Clock signal is not present; control board is faulty.

E16: (STE DUART failed)

No characters are output through the V24 interface.
Interface component on the control board is faulty.

E17: (STE A/D Converter failed)

The test measurement was not completed during initialization.
Control board is faulty.

E20: STE Ref U > -10.02 V

Limit at -10.02 V. The reference voltage is generated on the control board.
Control board is faulty.

E21: STE Ref U < -10.44 V

Limit at -10.44 V.
The reference voltage is generated on the control board.
Control board is faulty.

W22: STE Battery U < 3 V

The battery voltage (U_{batt}) on the control board has dropped below 3 V.
The battery on the control board must be exchanged.

E 23: OPTION U24 > 30 V

$U > 30$ V at the options socket.
- A voltage which is too high has been applied to pin 1 of the OPTION socket.
- 24 V power supply in the UL 200 has developed a fault.

E 24: OPTION U24 < 20 V

24 V at pin 1 of the OPTION socket is too low.
 $U < 20$ V. Fuse on the I/O board has blown.

E 25: IO Valve U < 7 V

The voltage for the valves is dropped to under 8 V; affects V1, for example.
I/O board is faulty.

E26: IO Valve > 10 V

When the voltage for the valves has dropped, the voltage is > 10 V; affects V1, for example.
I/O board is faulty.

E30: FB U24 < 20 V

Voltage for the hand unit is too low $U < 20$ V. Possibly the fuse (9/10) on the wiring backplane has blown.

E32: Amp T > 60 °C

Temperature of the preamplifier is too high $T > 60$ °C.
- Ambient temperature is too high.
- Air filters are dirty and must be exchanged.

W33: Amp T < 10 °C

- The temperature sensor in the preamplifier signals T < 10 °C.
Run-up time for the forevacuum pump will be longer.
- Temperature sensor faulty.

E34: MSV U24 > 18.3 V

- Signal MVPZN on the MSV board is active;
24 V signal voltage is too low U < 18.3 V.
- Fuse F1 on the MSV board has blown.
 - 24 V power supply voltage is missing.

!!! Switch the UL 200 off!!

- The missing voltage will cause the exhaust valve on the rotary vane pump to close which in turn can lead to a contamination of the vacuum system. Clean the UL 200 as required and check the oil level.
- Reference voltage UREF on the MSV board XT7/1 is too high > 5 V.

E35: MSV Anod-Cat-U > 130 V

- Anode-Cathode voltage is too high, U > 130 V.
MSV is faulty.

E36: MSV Anod-Cat-U < 30 V

- Anode-Cathode voltage is too low, U < 30 V.
MSV is faulty.

E37: MSV Sup-Nom U>>

- Signal MFSZH on MSV board is active.
Suppressor signal command variable is too high.
- Suppressor voltage has a short circuit.
- MSV is faulty.

E38: MSV Sup-Pot > 363 V

- U > 363 V
MSV is faulty.

E39: MSV Sup-Pot < 297 V

- U < 297 V
MSV is faulty.

E40: MSV Anod-Pot U>>

- The actual anode potential exceeds its nominal value by 10 %.
The nominal value can be displayed in the service menu (line 55).
MSV is faulty.

E41: MSV Anod-Pot U<<

- The actual anode potential has dropped below its nominal value by over 10%. The nominal value can be displayed in the service menu (line 55).
MSV is faulty.

E42: MSV Anod-Nom U>>

- Signal MFAZH on MSV board is active.
- Anode voltage has been short-circuited.
 - Nominal value of the anode voltage is too high. Anode voltage is limited to about 1,200 V.

E43: MSV Cat-Heater I>>

- Signal MPKZH on MSV board is active; cathode current is too high;
I > 3.6 A
MSV is faulty.

E44: MSV Cat-Heater I<<

- Signal MPKZN on MSV board is active; cathode current is too low;
I < 0.2 A
MSV is faulty.

W45: MSV Cathode 1 defect

- Signal MSIBE on MSV board is not active.
Emission for cathode 1 can not be switched on.
UL 200 switches to cathode 2.
Warning is repeated when switching on the UL 200 the next time. The warning will cease to appear when switching on the emission for cathode 1 manually through the service menu.
Order a new ion source.

W46: MSV Cathode 2 defect

- Signal MSIBE on MSV board is not active.
Emission for cathode 2 can not be switched on.
UL 200 switches to cathode 1.
Warning is repeated when switching on the UL 200 the next time.
The warning will cease to appear when switching on the emission for cathode 2 manually through the service menu.
Order a new ion source.

E47: MSV Cathodes defect

- Signal MSIBE on MSV board is not active.
Emission can not be switched on.
- Exchange the cathodes by exchanging the ion source.
After having exchanged the ion source it must be possible to switch on both cathodes manually via the service menu.

E48: MSV Fuse F2 defect

- Signal MSAFD on MSV board is active; anode heater fuse has blown.
Replace fuse F2 on the MSV board.

E49: TMP-Fail

- Signal on the NT 12 is active.
Turbomolecular pump has failed.
Priority: 1
- Fuse (1 A) in the NT 12 has blown.
 - Turbomolecular pump is faulty.

E50: TMP No Clock

- Clock from the frequency converter has failed.
Priority: 2
- NT 12 is faulty.

E51: TMP-Freq F>1100 Hz

- TMP frequency is too high f = 1100 Hz
Priority: 3
- NT 12 is faulty.

E52: TMP-Freq F<<,t>5min

TMP frequency is too low.

The frequency of $f = 1000$ Hz has not been reached after $t = 5$ minutes. Time t starts as soon as the pressure has dropped below the PV threshold pressure of

PV = 1 mbar;

Priority: 3

- NT 12 is faulty.
- Turbomolecular pump is faulty.

E53: TMP-FREQ<<

TMP frequency too low.

- Signal TMP-Normal is no longer active
- Fuse F4 has blown
- NT 12 faulty
- Turbomolecular pump faulty

E54: Electr. T>60 °C

The temperature on the electronics side is too high

$T > 60$ °C.

- Ambient temperature is too high.
- Internal ventilation has failed.
- Air filters are dirty and must be exchanged.

W55: Electr. T<10°C

- The temperature sensor on the wiring plane indicates $T < 10$ °C.

The forevacuum pump will take longer to run up.

- The temperature sensor is faulty.

E56: PE defect U<270mV

$U < 0.27$ V; filament broken.

Exchange the sensing cell on the Thermovac which measures PE.

E57: PE U>9.5V

The bridge voltage PE > 9.5 V for over 500 ms; see service menu item 92.

Realign on I/O board, or exchange the sensing cell on the Thermovac gauge (short circuited or low resistance filament).

This error message is not checked during the pumpdown process and during „Vent“.

E58: PV defect U<270mV

$U < 0.27$ V; filament broken.

Exchange the sensing cell on the Thermovac which measures PV.

E59: PV U>9.5V

The bridge voltage PV > 9.5 V for over 500 ms; see service menu item 92.

Realign on I/O board, or exchange the sensing cell on the Thermovac gauge (short circuited or low resistance filament).

This error message is not checked during the pumpdown process and during „Vent“.

W60: PV> 1mbar,t=5min

Pv > 1 mbar after $t = 5$ minutes since switching on.

Run up time for the forevacuum pump is too long.

E61: Emission Fail

Emission should be switched on. MSV subassembly indicates a fault.

MENB emission current not within range.

E62: Capillary blocked

In the sniffer mode the intake pressure of the sniffer line is controlled. If the pressure falls below 0.1 mbar, the flow through the capillary is too low (contamination) or the capillary is blocked (foreign objects, particles).

E63: Capillary broken

In the sniffer mode the intake pressure of the sniffer line is controlled. If the pressure exceeds 0.3 mbar, the flow through the capillary is too big (no leak tightness, broken capillary)

Application-Related Problems

W71: No Part. Flow Valve

No return signal from the partial flow valve after it has been activated.

24 V missing at OPTION pin 6.

Partial flow valve has not been properly connected or it is faulty.

W72: Emission Off PE>>

PE $>> 0.2$ or 3 mbar.

Due to an air inrush, for example.

The UL 200 will again try to resume the measurement mode.

W73: Emission Off PV>>

PV $>> 0.2$ or 3 mbar

Due to an air inrush, for example.

The UL 200 will again try to resume the measurement mode.

W75: EVAC stopped Time 1

See explanations for menu item 10.

- Check the application.
- Optimize Time 1.

W76: EVAC stopped Time 2

See explanations for menu item 10.

- Check the application.
- Optimize Time 2.

E77: Peak not in Range

The signal maximum has shifted to the mass range alignment limits.

- Check the basic setting for the anode voltage through the service menu.
- Check calibrated leak.

W78: Difference too small

The amplifier voltage difference between opened and closed calibrated leak is less than 10 mV.

Calibrated leak has not been closed properly.

W79: Signal too small

Calibrated leak is too small or has not been opened.
Pre-amplifier voltage < 10 mV.
The tune process is ignored and the calibration process is continued.

W80: Request for Cal

Request for calibration.
See explanations for menu item 24.
Since the last request for calibration, the temperature has changed by 5 °C or the UL 200 has warmed up for 30 minutes.

W81: Factor out of Range

The calculated factor falls out of the valid range. The old factor which has been calculated is retained.

Possible fault cause:

- The conditions for calibration have not been maintained.
- The leak rate of the calibrated leak which was entered is much too high or much too small.

W93: Syntax Error

See interface description SB 10.211.

Abbreviations which are used:

FB	Hand unit
MSV	Mass spectrometer supply (the rear board of the two electronics boards)
STE	Control board = CPU board (the front board of the two electronics boards)
TMP	Turbomolecular pump

Software Problems**W84: EEPROM Write XX**

The parameter could not be written into the EEPROM.
XX indicates the number of the parameter.

E85: Parameter Lost XX

At least one parameter has been lost.
The UL 200 will assume the default value for that parameter.
Check trigger values and calibrate the instrument. XX indicates the number of the parameter.

W86: FB Timeout

No data have been received from the hand unit for 500 ms.
This error occurs as a follow-up error to error numbers 1 ... 5.
The hand unit has not been connected.

E87: FB CRC-Error

The data from the hand unit have not been received correctly over a period of 500 ms.
- Faulty data link.

W88: Serial Parity

See interface description SB 10.211.

W89: Serial Framing

See interface description SB 10.211.

W90: Serial Overrun

See interface description SB 10.211.

W91: Serial B. Overrun

See interface description SB 10.211.

W92: Serial Missing EOS

See interface description SB 10.211.

5 Definition of Terms

<p>Autoranging</p>	<p>The range of the preamplifier and the vacuum ranges are selected automatically.</p> <p>The autoranging feature of the UL 200 covers the entire range or leak rates depending on the selected operating mode: „2: Mode Vacuum“, „2: Mode Sniff N/QT“ or „2: Mode Partial normal/oil-free“. Not only the leak rate signal, but also the pressure in the test sample (inlet pressure PE) and the forevacuum pressure (PV) are used for control purposes. Range switching between the main ranges is performed via valves. Fine range switching within the main ranges is implemented by switching over the gain factor of the preamplifier.</p>	<p>the lowest value which can be obtained. In this way the values adapt automatically to a decaying background (adaptive background correction).</p> <p>The entire measurement process may take up to 10 s after operating STOP. However, this process is interrupted automatically when operating the START push-button in the mean time.</p>
<p>Autotune, mass alignment</p>	<p>This function automatically aligns the mass spectrometer so that a maximum leak rate is displayed. The control computer changes the voltage which accelerates the ions in the selected mass range until a maximum ion current is detected by the ion detector. During each calibration the mass alignment is run automatically.</p>	<p>Basic menu</p> <p>Comprises menu lines 1 to 9. This part of the menu is not protected by a password. For details please refer to Chapter 2.5 and 2.5.4 (menu line 14).</p>
<p>Autozero</p>	<p>Determination and compensation of the helium background.</p> <p>With this function, the internal Zero level of the leak rate signal is determined in order to avoid a readout of the internal helium background and mistaking it as a proper measured value.</p> <p>This function is run automatically each time when pressing STOP to enter Standby or Vent, or when entering the CAL mode. The Zero measurement is only run in the most sensitive preamplifier range and it is calculated for the other ranges. The Zero values which have been determined in this way for the various measurement ranges are stored and are used to correct all leak rates which are determined later on.</p> <p>If subsequently negative leak rates are obtained due to this correction, the stored offset values are changed so that Zero will be</p>	<p>CONTROL</p> <p>Control connection on the rear of the instrument.</p> <p>Default condition</p> <p>Status of the UL 200 when supplied by the factory.</p> <p>Extended menu</p> <p>Comprises menu lines 10 to 49. Access to this part of the menu can be restricted / or enabled by entering the first password (see also Chapter 2.5).</p> <p>FINE</p> <p>Valves V2a and V4 are open; PE < 0.2 mbar; the turbomolecular pump with its high pumping speed is connected to the inlet flange.</p> <p>GROSS</p> <p>Valves V2a and V2b are open; PE = 0.2 ... 3 mbar.</p> <p>Internal helium background</p> <p>The existing helium partial pressure in the measurement system. The level of the internal helium background is measured in the Standby mode and subtracted from the measured signal.</p> <p>Measure, measurement mode</p> <p>The UL 200 measures the leak rate of the test sample.</p> <p>Menu item</p> <p>Menu lines numbered from 1 ... 99.</p> <p>Standby</p> <p>Mode which is attained by operating the STOP push-button; the START LED on the hand unit is turned off. The LCD display (3/2) indicates the message Standby. All valves leading to the test connection are closed. The measurement system is internally disconnected from the test connection.</p>

Service menu	Comprises menu lines 50 to 99. The service menu is called up by operating the Service push-button (see also Chapter 2.5 and 2.5.4).
Partial flow range 1	Valves V2a, V4.1 and V8 are open; PE = 1 ... 100 mbar.
Partial flow range 2	Valves V2a, V2b and V8 are open; PE = 0.1 ... 2 mbar; equivalent to the GROSS state plus additional external partial flow pump.
Partial flow range 3	Valves V2a, V4 and V8 are open; PE = 0.01 ... 0.1 mbar; equivalent to the FINE state plus additional external partial flow pump.

Declaration of Contamination of Vacuum Equipment and Components

The repair and/or service of vacuum equipment and components will only be carried out if a correctly completed declaration has been submitted. Non-completion will result in delay. The manufacturer could refuse to accept any equipment without a declaration.

This declaration can only be completed and signed by authorized and qualified staff.

Copies: Page 1 (white) to manufacturer or representative - Page 2 (yellow) attach to consignment packaging securely - Page 3 (blue) copy for file of sender

1. Description of Vacuum Equipment and Components - Equipment type/model: _____ - Code No.: _____ - Serial No.: _____ - Invoice No.: _____ - Delivery date: _____	2. Reason for Return _____ _____ _____ _____
---	---

3. Condition of the Vacuum Equipment and Components - Has the equipment been used? yes <input type="checkbox"/> no <input type="checkbox"/> - What type of pump oil/liquid was used? _____ - Is the equipment free from potentially harmful substances? yes <input type="checkbox"/> (go to Section 5) no <input type="checkbox"/> (go to Section 4)	4. Process related Contamination of Vacuum Equipment and Components: - toxic yes <input type="checkbox"/> no <input type="checkbox"/> - corrosive yes <input type="checkbox"/> no <input type="checkbox"/> - explosive*) yes <input type="checkbox"/> no <input type="checkbox"/> - biological hazard*) yes <input type="checkbox"/> no <input type="checkbox"/> - radioactive*) yes <input type="checkbox"/> no <input type="checkbox"/> - other harmful substances yes <input type="checkbox"/> no <input type="checkbox"/>
---	---

*) Vacuum equipment and components which have been contaminated by biological explosive or radioactive substances, will not accepted without written evidence of decontamination!

Please list all substances, gases and by-products which may have come into contact with the equipment:

Trade name Product name Manufacturer	Chemical name (or Symbol)	Dangerous material class	Measures if spillage	First aid in case of human contact
1.				
2.				
3.				
4.				
5.				

5. Legally Binding Declaration

I hereby declare that the information supplied on this form is complete and accurate. The despatch of the contaminated vacuum equipment and components will be in accordance with the appropriate regulations covering Packaging, Transportation and Labelling of Dangerous Substances.

Name of organisation or company: _____

Address: _____ Post code: _____

Tel.: _____

Fax: _____ Telex: _____

Name: _____

Job title: _____

Date: _____ Company stamp: _____

Legally binding signature: _____



LEYBOLD INFICON

Bonner Strasse 498 (Bayenthal)
D-50968 Cologne

Tel.: + 49 (221) 347-0

Fax: + 49 (221) 347-1250

<http://www.leyboldvac.de>

e-mail: documentation@leyboldvac.de