

MKS Type LDM-A Local Display Module

Copyright © 2009 by MKS Instruments, Inc.

All rights reserved. No part of this work may be reproduced or transmitted in any form or by any means, electronic or mechanical, including photocopying and recording, or by any information storage or retrieval system, except as may be expressly permitted in writing by MKS Instruments, Inc.

Baratron[®] is a registered trademark of MKS Instruments, Inc., Andover, MA

Bendix[®] is a registered trademark of Amphenol Corp., Bendix Connector Operations, Sidney, NY

Table of Contents

Safety Information	7
Symbols Used in This Instruction Manual.....	7
Symbols Found on the Unit	8
Safety Procedures and Precautions	9
Sicherheitshinweise.....	10
In dieser Betriebsanleitung vorkommende Symbole	10
Am Gerät angebrachte Symbole	11
Sicherheitsvorschriften und Vorsichtsmaßnahmen.....	12
Informations relatives à la sécurité	13
Symboles utilisés dans ce manuel d'utilisation	13
Symboles apparaissant sur l'appareil	14
Mesures de sécurité et mises en garde	15
Información sobre seguridad.....	16
Símbolos usados en el manual de instrucciones	16
Símbolos que aparecen en la unidad.....	17
Procedimientos y precauciones de seguridad.....	18
Chapter One: General Information	19
Introduction.....	19
Mounting Style	19
How This Manual is Organized	20
Customer Support	20
Chapter Two: Installation	21
How To Unpack the Type LDM-A Unit.....	21
Unpacking Checklist.....	21
Product Location and Requirements.....	22
Operating Environmental Requirements.....	22
Setup	23
Dimensions	23

Electrical Information	25
Electrical Information for the Voltage Version	26
Electrical Information for the 4 to 20 mA Version	29
Rotating the Display	32
Installing the Panel Mount Version	33
Chapter Four: Operation and Maintenance	35
Operating Information	35
Overpressure Reading	35
Displaying Pressures Values Over 1999	35
Maintenance	36
Appendix A: Product Specifications	37
Physical Specifications	37
Performance Specifications	38
Environmental Specifications	38
Appendix B: Model Code Explanation	39
Mode Code Description	39
Type Number	39
Pressure Range	39
Engineering Units	40
Calibration Type	40
Power Input and Transducer Signal	40
Transducer Connector	41
System Connector	41
Mounting Style	41
Index	43

List of Figures and Tables

Figures

Figure 1: Dimensions of the LDM-A Readout	23
Figure 2: Dimensions of the Panel Mount Bracket.....	24

Tables

Table 1: Definition of Symbols Found on the Unit	8
Tabelle 2: Definitionen der am Gerät angebrachten Symbole	11
Tableau 3: Définition des symboles apparaissant sur l'appareil.....	14
Tabla 4: Definición de los símbolos que aparecen en la unidad	17
Table 5: Dimension Variations for Each Connector Type.....	23
Table 6: Interface Cables	25
Table 7: Voltage Version Flying Leads Pinout (Model Code L).....	26
Table 8: Voltage Version Flying Leads Pinout (Model Code F).....	26
Table 9: Voltage Version Bendix Pinout	26
Table 10: Voltage Version 9-Pin Type “D” Pinout	27
Table 11: Voltage Version 15-Pin Type “D” Pinout	28
Table 12: 4 to 20 mA Version Flying Leads Pinout (Model Code L)	29
Table 13: 4 to 20 mA Version Flying Leads Pinout (Model Code F)	29
Table 14: 4 to 20 mA Version Bendix Pinout.....	29
Table 15: 4 to 20 mA Version 9-Pin Type “D” Pinout.....	30
Table 16: 4 to 20 mA Version 15-Pin Type “D” Pinout.....	31

Safety Information

Symbols Used in This Instruction Manual

Definitions of WARNING, CAUTION, and NOTE messages used throughout the manual.

Warning

The **WARNING** sign denotes a hazard. It calls attention to a procedure, practice, condition, or the like, which, if not correctly performed or adhered to, could result in injury to personnel.

Caution

The **CAUTION** sign denotes a hazard. It calls attention to an operating procedure, practice, or the like, which, if not correctly performed or adhered to, could result in damage to or destruction of all or part of the product.

Note

The **NOTE** sign denotes important information. It calls attention to a procedure, practice, condition, or the like, which is essential to highlight.

Symbols Found on the Unit

The following table describes symbols that may be found on the unit.















Definition of Symbols Found on the Unit			
 On (Supply) IEC 417, No.5007	 Off (Supply) IEC 417, No.5008	 Earth (ground) IEC 417, No.5017	 Protective earth (ground) IEC 417, No.5019
 Frame or chassis IEC 417, No.5020	 Equipotentiality IEC 417, No.5021	 Direct current IEC 417, No.5031	 Alternating current IEC 417, No.5032
 Both direct and alternating current IEC 417, No.5033-a	 Class II equipment IEC 417, No.5172-a	 Three phase alternating current IEC 617-2 No.020206	
 Caution, refer to accompanying documents ISO 3864, No.B.3.1	 Caution, risk of electric shock ISO 3864, No.B.3.6	 Caution, hot surface IEC 417, No.5041	

Table 1: Definition of Symbols Found on the Unit

Safety Procedures and Precautions

The following general safety precautions must be observed during all phases of operation of this instrument. Failure to comply with these precautions or with specific warnings elsewhere in this manual violates safety standards of intended use of the instrument and may impair the protection provided by the equipment. MKS Instruments, Inc. assumes no liability for the customer's failure to comply with these requirements.

DO NOT SUBSTITUTE PARTS OR MODIFY INSTRUMENT

Do not install substitute parts or perform any unauthorized modification to the instrument. Return the instrument to an MKS Calibration and Service Center for service and repair to ensure that all safety features are maintained.

SERVICE BY QUALIFIED PERSONNEL ONLY

Operating personnel must not remove instrument covers. Component replacement and internal adjustments must be made by qualified service personnel only.

DO NOT OPERATE IN EXPLOSIVE ATMOSPHERES

To avoid explosion, do not operate this product in an explosive environment unless it has been specifically certified for such operation.

Sicherheitshinweise

In dieser Betriebsanleitung vorkommende Symbole

Definition der mit WARNUNG!, VORSICHT! und HINWEIS überschriebenen Abschnitte in dieser Betriebsanleitung.

Warnung!



Das Symbol **WARNUNG!** weist auf eine Gefahrenquelle hin. Es macht auf einen Arbeitsablauf, eine Arbeitsweise, einen Zustand oder eine sonstige Gegebenheit aufmerksam, deren unsachgemäße Ausführung bzw. ungenügende Berücksichtigung zu Körperverletzung führen kann.

Vorsicht!



Das Symbol **VORSICHT!** weist auf eine Gefahrenquelle hin. Es macht auf einen Bedienungsablauf, eine Arbeitsweise oder eine sonstige Gegebenheit aufmerksam, deren unsachgemäße Ausführung bzw. ungenügende Berücksichtigung zu einer Beschädigung oder Zerstörung des Produkts oder von Teilen des Produkts führen kann.

Hinweis



Das Symbol **HINWEIS** weist auf eine wichtige Mitteilung hin, die auf einen Arbeitsablauf, eine Arbeitsweise, einen Zustand oder eine sonstige Gegebenheit von besonderer Wichtigkeit aufmerksam macht.

Am Gerät angebrachte Symbole

Der untenstehenden Tabelle sind die Bedeutungen der Symbole zu entnehmen, die an dem Gerät angebracht sind.















Definitionen der am Gerät angebrachten Symbole			
			
Ein (Netz) IEC 417, Nr. 5007	Aus (Netz) IEC 417, Nr. 5008	Erde IEC 417, Nr. 5017	Schutzleiter IEC 417, Nr. 5019
			
Rahmen oder Chassis IEC 417, Nr. 5020	Äquipotentialanschluß IEC 417, Nr. 5021	Gleichstrom IEC 417, Nr. 5031	Wechselstrom IEC 417, Nr. 5032
			
Wechselstrom und Gleichstrom IEC 417, Nr. 5033-a	Geräteklasse II IEC 417, Nr. 5172-a	Drehstrom IEC 617-2 Nr. 020206	
			
Vorsicht! Bitte Begleitdokumente lesen! ISO 3864, Nr. B.3.1	Vorsicht! Stromschlaggefahr! ISO 3864, Nr. B.3.6	Vorsicht! Heiße Fläche! IEC 417, Nr. 5041	

Tabelle 2: Definitionen der am Gerät angebrachten Symbole

Sicherheitsvorschriften und Vorsichtsmaßnahmen

Die untenstehenden allgemeinen Sicherheitsvorschriften sind bei allen Betriebsphasen dieses Instruments zu befolgen. Jede Mißachtung dieser Sicherheitsvorschriften oder sonstiger spezifischer Warnhinweise in dieser Betriebsanleitung stellt eine Zuwiderhandlung der für dieses Instrument geltenden Sicherheitsstandards dar und kann die an diesem Instrument vorgesehenen Schutzvorrichtungen unwirksam machen. MKS Instruments, Inc. haftet nicht für eine Mißachtung dieser Sicherheitsvorschriften seitens des Kunden.

Keine Teile austauschen und keine Veränderungen vornehmen!

Bauen Sie in das Instrument keine Ersatzteile ein, und nehmen Sie keine eigenmächtigen Änderungen am Gerät vor! Schicken Sie das Instrument zu Wartungs- und Reparaturzwecken an einen MKS-Kalibrierungs- und -Kundendienst ein! Dadurch wird sichergestellt, daß alle Sicherheitseinrichtungen voll funktionsfähig bleiben.

Wartung nur durch qualifizierte Fachleute!

Das Gehäuse des Instruments darf vom Bedienpersonal nicht geöffnet werden. Das Auswechseln von Bauteilen und das Vornehmen von internen Einstellungen ist nur von qualifizierten Fachleuten durchzuführen.

Gerät nicht in explosiver Atmosphäre benutzen!

Um der Gefahr einer Explosion vorzubeugen, darf dieses Gerät nicht in der Nähe explosiver Stoffe eingesetzt werden, sofern es nicht ausdrücklich für diesen Zweck zertifiziert worden ist.

Informations relatives à la sécurité

Symboles utilisés dans ce manuel d'utilisation

Définition des indications AVERTISSEMENT, ATTENTION et REMARQUE utilisées dans ce manuel.

Avertissement



L'indication **AVERTISSEMENT** signale un danger potentiel. Elle est destinée à attirer l'attention sur une procédure, une utilisation, une situation ou toute autre chose présentant un risque de blessure en cas d'exécution incorrecte ou de non-respect des consignes.

Attention



L'indication **ATTENTION** signale un danger potentiel. Elle est destinée à attirer l'attention sur une procédure, une utilisation, une situation ou toute autre chose présentant un risque d'endommagement ou de dégât d'une partie ou de la totalité de l'appareil en cas d'exécution incorrecte ou de non-respect des consignes.

Remarque



L'indication **REMARQUE** signale des informations importantes. Elle est destinée à attirer l'attention sur une procédure, une utilisation, une situation ou toute autre chose présentant un intérêt particulier.

Symboles apparaissant sur l'appareil

Le tableau suivant décrit les symboles apparaissant sur l'appareil.















Définition des symboles apparaissant sur l'appareil			
			
Marche (sous tension) IEC 417, No. 5007	Arrêt (hors tension) IEC 417, No. 5008	Terre (masse) IEC 417, No. 5017	Terre de protection (masse) IEC 417, No. 5019
			
Masse IEC 417, No. 5020	Equipotentialité IEC 417, No. 5021	Courant continu IEC 417, No. 5031	Courant alternatif IEC 417, No. 5032
			
Courant continu et alternatif IEC 417, No. 5033-a	Matériel de classe II IEC 417, No. 5172-a	Courant alternatif triphase IEC 617-2 No. 020206	
			
Attention : se reporter à la documentation ISO 3864, No. B.3.1	Attention : risque de secousse électrique ISO 3864, No. B.3.6	Attention : surface brûlante IEC 417, No. 5041	

Tableau 3: Définition des symboles apparaissant sur l'appareil

Mesures de sécurité et mises en garde

Prendre toutes les précautions générales suivantes pendant toutes les phases d'utilisation de cet appareil. Le non-respect de ces précautions ou des avertissements contenus dans ce manuel entraîne une violation des normes de sécurité relatives à l'utilisation de l'appareil et le risque de réduire le niveau de protection fourni par l'appareil. MKS Instruments, Inc. ne prend aucune responsabilité pour les conséquences de tout non-respect des consignes de la part de ses clients.

NE PAS SUBSTITUER DES PIÈCES OU MODIFIER L'APPAREIL

Ne pas utiliser de pièces détachées autres que celles vendues par MKS Instruments, Inc. ou modifier l'appareil sans l'autorisation préalable de MKS Instruments, Inc. Renvoyer l'appareil à un centre d'étalonnage et de dépannage MKS pour tout dépannage ou réparation afin de s'assurer que tous les dispositifs de sécurité sont maintenus.

DÉPANNAGE EFFECTUÉ UNIQUEMENT PAR UN PERSONNEL QUALIFIÉ

L'opérateur de l'appareil ne doit pas enlever le capot de l'appareil. Le remplacement des composants et les réglages internes doivent être effectués uniquement par un personnel d'entretien qualifié.

NE PAS UTILISER DANS UNE ATMOSPHÈRE EXPLOSIVE

Pour éviter tout risque d'explosion, ne pas utiliser l'appareil dans une atmosphère explosive à moins qu'il n'ait été approuvé pour une telle utilisation.

Información sobre seguridad

Símbolos usados en el manual de instrucciones

Definiciones de los mensajes de ADVERTENCIA, PRECAUCIÓN Y OBSERVACIÓN usados en el manual.

Advertencia



El símbolo de **ADVERTENCIA** indica un riesgo. **Pone de relieve un procedimiento, práctica, condición, etc., que, de no realizarse u observarse correctamente, podría causar lesiones a los empleados.**

Precaución



El símbolo de **PRECAUCIÓN** indica un riesgo. **Pone de relieve un procedimiento, práctica, etc., de tipo operativo que, de no realizarse u observarse correctamente, podría causar desperfectos al instrumento, o llegar incluso a causar su destrucción total o parcial.**

Observación



El símbolo de **OBSERVACIÓN** indica información de importancia. **Pone de relieve un procedimiento, práctica, condición, etc., cuyo conocimiento resulta esencial.**

Símbolos que aparecen en la unidad

En la tabla que figura a continuación se indican los símbolos que aparecen en la unidad.















Definición de los símbolos que aparecen en la unidad			
 Encendido (alimentación eléctrica) IEC 417, N.º 5007	 Apagado (alimentación eléctrica) IEC 417, N.º 5008	 Puesta a tierra IEC 417, N.º 5017	 Protección a tierra IEC 417, N.º 5019
 Caja o chasis IEC 417, N.º 5020	 Equipotencialidad IEC 417, N.º 5021	 Corriente continua IEC 417, N.º 5031	 Corriente alterna IEC 417, N.º 5032
 Corriente continua y alterna IEC 417, N.º 5033-a	 Equipo de clase II IEC 417, N.º 5172-a	 Corriente alterna trifásica IEC 617-2 N.º 020206	
 Precaución. Consultar los documentos adjuntos ISO 3864, N.º B.3.1	 Precaución. Riesgo de descarga eléctrica ISO 3864, N.º B.3.6	 Precaución. Superficie caliente IEC 417, N.º 5041	

Tabla 4: Definición de los símbolos que aparecen en la unidad

Procedimientos y precauciones de seguridad

Las precauciones generales de seguridad que figuran a continuación deben observarse durante todas las fases de funcionamiento del presente instrumento. La no observancia de dichas precauciones, o de las advertencias específicas a las que se hace referencia en el manual, contraviene las normas de seguridad referentes al uso previsto del instrumento y podría impedir la protección que proporciona el instrumento. MKS Instruments, Inc., no asume responsabilidad alguna en caso de que el cliente haga caso omiso de estos requerimientos.

NO UTILIZAR PIEZAS NO ORIGINALES NI MODIFICAR EL INSTRUMENTO

No se debe instalar piezas que no sean originales ni modificar el instrumento sin autorización. Para garantizar que las prestaciones de seguridad se observen en todo momento, enviar el instrumento al Centro de servicio y calibración de MKS cuando sea necesaria su reparación y servicio de mantenimiento.

REPARACIONES EFECTUADAS ÚNICAMENTE POR TÉCNICOS ESPECIALIZADOS

Los operarios no deben retirar las cubiertas del instrumento. El cambio de piezas y los reajustes internos deben efectuarlos únicamente técnicos especializados.

EVITAR SU USO EN ENTORNOS EXPLOSIVOS

Para evitar el riesgo de explosión, no usar este instrumento o en un entorno explosivo, a no ser que haya sido certificado para tal uso.

Chapter One: General Information

Introduction

The LDM-A display module connects to your 700/800 Baratron® Series transducer to provide a 3½ digit readout of the pressure at the transducer. Versions are available that connect to transducers with the following connectors:

- 9-pin D-subminiature
- 15-pin High Density D-subminiature
- Bendix® 4 Position PTO

The LDM-A can connect to your system through one of the following connectors:

- Bendix 4 Position PTO
- 9-pin D-subminiature
- 15-pin High Density D-subminiature
- Flying Leads

The LDM-A connects to an absolute, gage (reference to atmospheric pressure), or compound calibration transducer with voltage or current (4 to 20 mA) input/output. The pressure reading is displayed in one pressure unit, specified when you ordered the LDM-A unit.

Note

The LDM-A does not include the additional wires necessary to support the optional trip points on some 700/800 Series transducers.

Mounting Style

The LDM-A is available in two mounting styles: transducer or panel mount. When the LDM-A is mounted directly on the transducer, use the zero pot provided by the transducer to zero the display reading. The panel mount unit provides a zero pot so you can zero the reading remotely. However, if the transducer is nearby you may choose to zero the panel mount version using the zero pot on the transducer.

How This Manual is Organized

This manual is designed to provide instructions on how to set up, install, and operate a Type LDM-A unit.

Before installing your Type LDM-A unit in a system and/or operating it, carefully read and familiarize yourself with all precautionary notes in the *Safety Messages and Procedures* section at the front of this manual. In addition, observe and obey all WARNING and CAUTION notes provided throughout the manual.

Chapter One, *General Information*, (this chapter) introduces the product and describes the organization of the manual.

Chapter Two, *Installation*, explains the environmental requirements and describes how to mount the instrument in your system.

Chapter Three, *Operation and Maintenance*, describes how to use the instrument and explains all the functions and features.

Appendix A, *Product Specifications*, lists the specifications of the instrument.

Appendix B, *Model Code Explanation*, describes the model code.

Customer Support

Standard maintenance and repair services are available at all of our regional MKS Calibration and Service Centers, listed on the back cover. In addition, MKS accepts the instruments of other manufacturers for recalibration using the Primary and Transfer Standard calibration equipment located at all of our regional service centers. Should any difficulties arise in the use of your Type LDM-A instrument, or to obtain information about companion products MKS offers, contact any authorized MKS Calibration and Service Center. If it is necessary to return the instrument to MKS, please obtain an RMA (Return Material Authorization) Number from the MKS Calibration and Service Center before shipping. The RMA Number expedites handling and ensures proper servicing of your instrument.

Please refer to the inside of the back cover of this manual for a list of MKS Calibration and Service Centers.

Warning



All returns to MKS Instruments must be free of harmful, corrosive, radioactive, or toxic materials.

Chapter Two: Installation

How To Unpack the Type LDM-A Unit

MKS has carefully packed the Type LDM-A unit so that it will reach you in perfect operating order. Upon receiving the unit, however, you should check for defects, cracks, broken connectors, etc., to be certain that damage has not occurred during shipment.

Note

Do *not* discard any packing materials until you have completed your inspection and are sure the unit arrived safely.

If you find any damage, notify your carrier and MKS immediately. If it is necessary to return the unit to MKS, obtain an RMA (Return Material Authorization) Number from the MKS Service Center before shipping. Please refer to the inside of the back cover of this manual for a list of MKS Calibration and Service Centers.

Caution

Only qualified individuals should perform the installation and any user adjustments. They must comply with all the necessary ESD and handling precautions while installing and adjusting the instrument. Proper handling is essential when working with all highly sensitive precision electronic instruments.

Unpacking Checklist

Standard Equipment:

- Type LDM-A Unit
- Type LDM-A Instruction Manual (this book)

Optional Equipment:

- Electrical Connector Accessories Kit - LDM-A-K1 (includes two (2) short screws and a new cover necessary to rotate units with a Type “D” connector)
- Interface cables, refer to *Electrical Information*, page 25, for details

Product Location and Requirements

Operating Environmental Requirements

- Ambient Operating Temperature: 0 °C to 50 °C (32°F to 122 °F)
- Operating Humidity Range: 0 to 95% relative humidity, non-condensing
- Ventilation requirements include sufficient air circulation

Setup

The transducer mount version attaches directly to the connector on the 700/800 Series transducer. The panel mount unit provides hardware to mount the unit securely in position.

Dimensions

Note  All dimensions are listed in inches with millimeters referenced in parentheses.

Transducer Mount Version

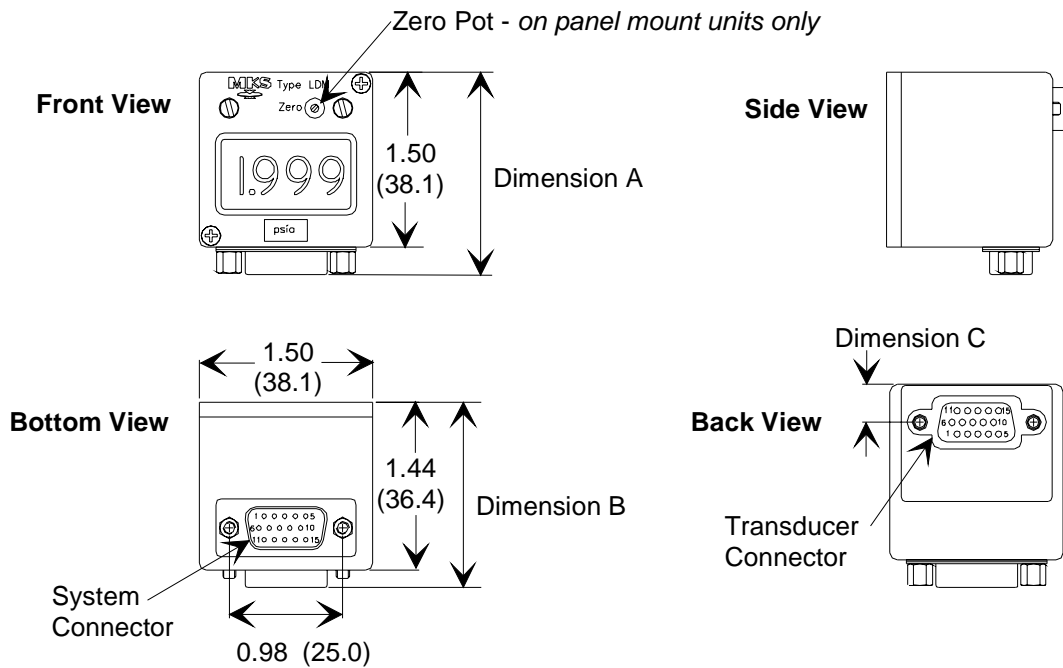

Figure 1: Dimensions of the LDM-A Readout

Dimension Variations for Each Connector Type		
	D-subminiature*	Bendix
Dimension A	1.74 (44.1)	2.01 (50.9)
Dimension B	1.58 (40.2)	1.97 (49.9)
Dimension C	0.32 (8.2)	0.5 (12.7)
* Applies to both the standard 9-pin and the High Density 15-pin connector		

Table 5: Dimension Variations for Each Connector Type

Panel Mount Version

The panel mount version enables you to mount the LDM-A unit in a panel or wall. The LDM-A is shipped from the factory with its mounting bracket attached.

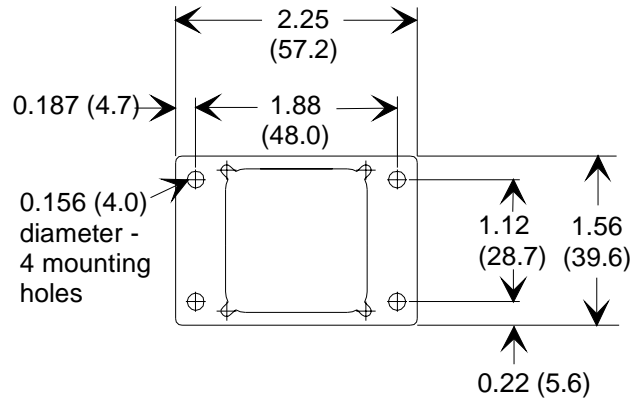

Figure 2: Dimensions of the Panel Mount Bracket

Electrical Information

You select the type of connector that connects the LDM-A to the transducer and the system. The transducer connector is located on the bottom of the unit; the system connector on the back of the unit. The pinouts listed in this section apply to the connector *type*, regardless of the connector location (transducer or system connector).

Note



1. Metal, braided shielded cables are required to meet CE Mark specifications.
2. To order a metal, braided, shielded cable, add an “S” after the cable type designation. For example, to order a connection cable, for an LDM-A unit with a 9-pin connector to a 146 unit, use part number CB700-1-X; for a metal, braided, shielded cable use part number CB700S-1-X.

Interface Cables			
LDM-A Connector	MKS Power Supply/Readout	Cable Description	Cable Number*
9-pin Type “D”	Type 146, 660	9-pin Type “D” to 15-pin Type “D”	CB700-1-X CB700S-1-X
	PDR-C-1, PDR-C-2	9-pin Type “D” to flying leads	CB700-2-X CB700S-2-X
Bendix	Type 146, 660	Bendix to 15-pin Type “D”	CB700-3-X CB700S-3-X
	PDR-C-1, PDR-C-2	Bendix to flying leads	CB700-4-X CB700S-4-X
15-pin High Density Type “D”	Type 146, 660	15-pin Type “D” to 15-pin Type “D”	CB700-5-X CB700S-5-X
	PDR-C-1, PDR-C-2	15-pin Type “D” to flying leads	CB700-6-X CB700S-6-X
<i>* where X indicates the length of the cable, in feet</i>			

Table 6: Interface Cables

Electrical Information for the Voltage Version

Note

Units with flying leads are not CE Mark compliant. As of July 20, 2009, all products shipped to the European Community must carry the CE Mark label. This label signifies compliance with the EMC Directive 2004/108/EEC, which covers radio frequency emissions and immunity tests.

Voltage Version Flying Leads Pinout (Model Code L)	
Wire	Assignment
Red	Power Input
Black	Power Return
White	Pressure Return
Green	Pressure Output

Table 7: Voltage Version Flying Leads Pinout (Model Code L)

Voltage Version Flying Leads Pinout (Model Code F)	
Wire	Assignment
Red	Pressure Output
Black	Pressure Return
White	Power Return
Green	Power Input

Table 8: Voltage Version Flying Leads Pinout (Model Code F)

Voltage Version Bendix Pinout	
Pin	Assignment
A	Power Input
B	Pressure Output
C	Pressure Return
D	Power Return

Table 9: Voltage Version Bendix Pinout

Voltage Version 9-Pin Type “D” Pinout	
Pin Number	Assignment
1	Pressure Output
2	No Connection
3	No Connection
4	Power Input
5	No Connection
6	No Connection
7	No Connection
8	Pressure Return
9	Power Return

Table 10: Voltage Version 9-Pin Type “D” Pinout

Note

The “No Connection” pin assignment refers to a pin with no internal connection.

Voltage Version 15-Pin Type “D” Pinout	
Pin Number	Assignment
1	No Connection
2	Pressure Output
3	No Connection
4	No Connection
5	Power Return
6	No Connection
7	Power Input
8	No Connection
9	No Connection
10	No Connection
11	No Connection
12	Pressure Return
13	No Connection
14	No Connection
15	No Connection

Table 11: Voltage Version 15-Pin Type “D” Pinout

Note

The “No Connection” pin assignment refers to a pin with no internal connection.

Electrical Information for the 4 to 20 mA Version

Note



Units with flying leads are not CE Mark compliant. As of January 1, 1996, all products shipped to the European Community must carry the CE Mark label. This label signifies compliance with the EMC Directive 89/336/EEC, which covers radio frequency emissions and immunity tests.

4 to 20 mA Version Flying Leads Pinout (Model Code L)	
Wire	Assignment
Red	4 to 20 mA positive excitation
Black	4 to 20 mA negative excitation
White	No Connection
Green	No Connection

Table 12: 4 to 20 mA Version Flying Leads Pinout (Model Code L)

4 to 20 mA Version Flying Leads Pinout (Model Code F)	
Wire	Assignment
Red	No Connection
Black	No Connection
White	4 to 20 mA negative excitation
Green	4 to 20 mA positive excitation

Table 13: 4 to 20 mA Version Flying Leads Pinout (Model Code F)

4 to 20 mA Version Bendix Pinout	
Pin	Assignment
A	4 to 20 mA positive excitation
B	No Connection
C	No Connection
D	4 to 20 mA negative excitation

Table 14: 4 to 20 mA Version Bendix Pinout

Note

The “No Connection” pin assignment refers to a pin with no internal connection.

4 to 20 mA Version 9-Pin Type “D” Pinout	
Pin Number	Assignment
1	No Connection
2	No Connection
3	No Connection
4	4 to 20 mA positive excitation
5	No Connection
6	No Connection
7	No Connection
8	No Connection
9	4 to 20 mA negative excitation

Table 15: 4 to 20 mA Version 9-Pin Type “D” Pinout

4 to 20 mA Version 15-Pin Type “D” Pinout	
Pin Number	Assignment
1	No Connection
2	No Connection
3	No Connection
4	No Connection
5	4 to 20 mA negative excitation
6	No Connection
7	4 to 20 mA positive excitation
8	No Connection
9	No Connection
10	No Connection
11	No Connection
12	No Connection
13	No Connection
14	No Connection
15	No Connection

Table 16: 4 to 20 mA Version 15-Pin Type “D” Pinout

Note

The “No Connection” pin assignment refers to a pin with no internal connection.

Rotating the Display

The display can be rotated $\pm 90^\circ$ for easy reading.

Caution



Only qualified individuals should perform the installation and any user adjustments. They must comply with all the necessary ESD and handling precautions while installing and adjusting the instrument. Proper handling is essential when working with all highly sensitive precision electronic instruments.

Note



If your LDM-A unit connects to the transducer with either a 9-pin Type “D” or a 15-pin High Density Type “D” connector, you will need the LDM-A-K1 Accessories Kit to reattach the display. The Bendix connector does not require the Accessories Kit.

Units with a Type “D” Transducer Connector

Equipment Required: LDM-A-K1 Accessories Kit
 Phillips screw driver
 Static ground strap (must be worn)

1. With the LDM-A disconnected from the system, remove the two cover screws and carefully lift off the cover (the meter display snaps into the cover).
2. Remove the existing long connector screws.
3. Gently lift the display out of the enclosure slightly and move it to one side.
 The hole for one connector screw will be visible on the bottom of the LDM-A enclosure.
4. Insert one small connector screw, provided in the LDM-A-K1 Accessories Kit, into the hole in the bottom of the LDM-A enclosure to fasten the LDM-A connector to the transducer.
5. Gently move the display to the other side and insert the second connector screw.
6. Rotate the display $\pm 90^\circ$ and insert it back into the enclosure.

Caution



-
1. **Rotating the display 180° may damage the unit.**
 2. **Do not force the display into the enclosure. If the display does not go into the enclosure easily check the alignment of the display inside the enclosure.**
-

7. Position the new cover (included in the Accessories Kit) over the display.
8. Replace the two cover screws.

10. Reconnect the LDM-A to the system.

Units with a Bendix Transducer Connector

Equipment Required: Phillips screw driver
 Static ground strap (must be worn)

1. With the LDM-A connected to the transducer, loosen the small set screw.
2. Gently lift the top (which holds the meter display) and rotate it $\pm 90^\circ$.

Caution

Rotating the display 180° may damage the unit.

3. Insert the top back into the enclosure.

Caution

Do not force the display into the enclosure. If the display does not go into the enclosure easily, check the alignment of the display inside the enclosure.

4. Tighten the set screw.

Installing the Panel Mount Version

The panel mount version is shipped from the factory with the mounting bracket attached. The mounting bracket has four mounting holes, one at each corner of the unit, as shown in Figure 2, page 24. Use these mounting holes to secure the LDM-A unit to a panel or wall.

This page intentionally left blank.

Chapter Four: Operation and Maintenance

Operating Information

Overpressure Reading

The display will *blank out* when the pressure exceeds approximately 110% full scale.

Displaying Pressures Values Over 1999

The LDM-A is calibrated at the factory to operate in the pressure range specified when you ordered the unit. (Refer to *Mode Code Description*, page 39.)

The 3½ digit display can read a maximum value of 1999. If the full scale range of your transducer exceeds 1999, the factory configuration will position the decimal point to read 1/1000 of full scale. A “x1K” label will be affixed to the front of the unit, along with the appropriate pressure units label. For example, to display 3000 psi, the meter will be configured to read 3.00 and a “x1K” label will be positioned next to the display and the “psi” label.

Maintenance

In general, the LDM-A unit requires no maintenance. However, periodically check for wear on the cables and inspect the enclosure for visible signs of damage.

Appendix A: Product Specifications

Physical Specifications

Connectors Transducer (female) System (male)	9-pin Type "D," 15-pin High Density Type "D," or Bendix 9-pin Type "D," 15-pin High Density Type "D," Bendix, or flying leads (6 ft.)
Dimensions Panel mount bracket	1.5" width x 1.5" depth x 1.97" height (Bendix connector) 38.1 mm x 38.1 mm x 49.9 (height with a Bendix connector) 2.25" width x 0.031 depth" x 1.56" height (enclosure only) 57.2 mm x 0.79 mm x 39.6 mm
Display Voltage Version 4 to 20 mA Version	3½ digits, minimum ¼ inch character size, ability to display a negative (-) sign, factory set decimal point Overrange indicated by blanking low digits 7 segment LED 7 segment LCD
Input for the Voltage Version Input Impedance Input Power	>10K ohm +13 to 32 VDC @ 15 mA maximum
Input for the 4 to 20 mA Version Input Impedance Input Power	<50 ohm 4 to 20 mA loop powered (maximum voltage drop 3.3 VDC)
Signal (from Transducer) Voltage Version 4 to 20 mA Version	0 to 5 VDC or 0 to 10 VDC (factory configured) 4 to 20 mA
Overvoltage Protection Limit	30 VDC
Weight	3 oz. (85.0 g)

Performance Specifications

Accuracy	$\pm 0.1\%$ of Reading ± 1 digit
CE Mark Compliance	EMC Directive 2004/108/EEC <i>Note: Units with flying leads are not CE Mark compliant.</i>
Temperature Coefficient	0.2% Full Scale/ $^{\circ}\text{C}$

Environmental Specifications

Operating Humidity Range	0 to 70% RH, non-condensing
Operating Temperature Range	0 $^{\circ}$ to 50 $^{\circ}$ C (32 $^{\circ}$ to 122 $^{\circ}$ F)
Storage Temperature Range	-20 $^{\circ}$ to 80 $^{\circ}$ C (-4 $^{\circ}$ to 176 $^{\circ}$ F)

Due to continuing research and development activities, these product specifications are subject to change without notice.

Appendix B: Model Code Explanation

Mode Code Description

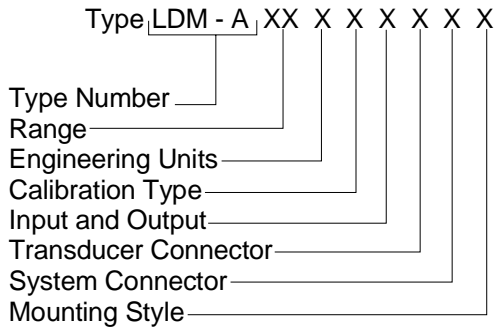

Type Number

The type number identifies the LDM-A.

Pressure Range

Ensure that the LDM-A is configured for the same range as your transducer *before* you connect the two units.

The full scale pressure range is defined by the two places (XX) following the product revision letter. The first digit represents the significant number. The second digit specifies the number of zeros. For example, to order a 1000 Torr unit, the pressure range code would be 13. To order a 60 psia unit, the pressure range code would be 61. One exception is the value 250, which uses the code "RD."

Engineering Units

The LDM-A is configured to display the pressure reading in one of the pressure units, shown in the following table. Compound calibration versions must use the same pressure units for positive and negative pressure readings.

Engineering Units Selection	
Ordering Code	Unit
B	bar
G	kg/cm ²
H	in Hg
K	kiloPascal
L	Pascal
M	millibar
P	psi
T	Torr (mmHg)
W	in H ₂ O

Calibration Type

The calibration type is specified by the fifth letter in the model code: absolute (A), gage pressure (B), or compound (C) calibration.

Power Input and Transducer Signal

The LDM-A can connect to transducers with the power input and signal options shown.

Power Input and Output Options		
Ordering Code	Input Power	Transducer Signal
2	+13 to 32 VDC	0 to 10 VDC
3	+12 to 32 VDC	0 to 5 VDC
4	4 to 20 mA	4 to 20 mA

Transducer Connector

The LDM-A is available with a variety of connectors to attach to the transducer. Select the type of connector on your transducer.

Transducer Connector Options	
Ordering Code	Connector
A	9-pin Type "D"
C	15-pin High Density Type "D"
D	4 position Bendix

System Connector

Several connectors are available to connect the LDM-A to your system.

System Connector Options	
Ordering Code	Connector
A	9-pin Type "D"
C	15-pin High Density Type "D"
D	4 position Bendix
F	Flying Leads (6 ft.) option 1
L	Flying Leads (6 ft.) option 2

Mounting Style

Two mounting styles are available: transducer (1) or panel (2) mount.

This page intentionally left blank.

Index

A

Accuracy, 38

B

Baratron, 19

C

Cables, 25

CE Mark, 25, 38

Connector, 41

Connectors, 19, 25–31

Customer support, 20

D

Dimensions, 23, 37

Display, 19, 32, 37

Display, rotating, 32

E

Electrical, 25–31, 37

H

Humidity, 22

I

Input, 37

Installation Category, 22

L

Labels, 35

M

Maintenance, 36

Manual organization, 20

Model code, 39–41

Mounting, 19, 24, 41

O

Overpressure, 35

P

Panel Mount, 24, 33

Pollution Degree, 22

Pressure range, 39

Pressure units, 35, 40

R

Returning the product, 20, 21

S

Specifications, 37–38

T

Temperature, 22

Transducer, 19

Trip points, 19

U

Units, 40