



Agilent Technologies

Vacuum Products Division

CE

Agilent Technologies Helium Leak Detector

*MODELS: G8610A, G8610B, G8611A, G8611B,
G8611C, G8612A, G8612B, G8612C, AND
G8612D*

OPERATION MANUAL

Manual No. G8610-90002
Revision A
December 2017

Agilent Technologies Helium Leak Detector



Contra-Flow is a trademark or registered trademark of Agilent, Inc.

Alconox is a registered trademark of Alconox, Inc.

Apiezon is a registered trademark of M&I Materials Ltd.

Warranty

Products manufactured by Seller are warranted against defects in materials and workmanship for twelve (12) months from date of shipment thereof to Customer, and Seller's liability under valid warranty claims is limited, at the option of Seller, to repair, to replace, or refund of an equitable portion of the purchase price of the Product. Items expendable in normal use are not covered by this warranty. All warranty replacement or repair of parts shall be limited to equipment malfunctions which, in the sole opinion of Seller, are due or traceable to defects in original materials or workmanship. All obligations of Seller under this warranty shall cease in the event of abuse, accident, alteration, misuse, or neglect of the equipment. In-warranty repaired or replaced parts are warranted only for the remaining unexpired portion of the original warranty period applicable to the repaired or replaced parts. After expiration of the applicable warranty period, Customer shall be charged at the then current prices for parts, labor, and transportation.

Reasonable care must be used to avoid hazards. Seller expressly disclaims responsibility for loss or damage caused by use of its Products other than in accordance with proper operating procedures.

Except as stated herein, Seller makes no warranty, express or implied (either in fact or by operation of law), statutory or otherwise; and, except as stated herein, Seller shall have no liability under any warranty, express or implied (either in fact or by operation of law), statutory or otherwise. Statements made by any person, including representatives of Seller, which are inconsistent or in conflict with the terms of this warranty shall not be binding upon Seller unless reduced to writing and approved by an officer of Seller.

Warranty Replacement and Adjustment

All claims under warranty must be made promptly after occurrence of circumstances giving rise thereto, and must be received within the applicable warranty period by Seller or its authorized representative. Such claims should include the Product serial number, the date of shipment, and a full description of the circumstances giving rise to the claim. Before any Products are returned for repair and/or adjustment, written authorization from Seller or its authorized representative for the return and instructions as to how and where these Products should be returned must be obtained. Any Product returned to Seller for examination shall be prepaid via the means of transportation indicated as acceptable by Seller. Seller reserves the right to reject any warranty claim not promptly reported and any warranty claim on any item that has been altered or has been returned by non-acceptable means of transportation. When any Product is returned for examination and inspection, or for any other reason, Customer shall be responsible for all damage resulting from improper packing or handling, and for loss in transit, notwithstanding any defect or non-conformity in the Product. In all cases, Seller has the sole responsibility for determining the cause and nature of failure, and Seller's determination with regard thereto shall be final.

If it is found that Seller's Product has been returned without cause and is still serviceable, Customer will be notified and the Product returned at Customer's expense; in addition, a charge for testing and examination may be made on Products so returned.

This page intentionally left blank.

Table of Contents

Preface	13
Documentation Standards	13
Hazard and Safety Information	14
Agilent Services	23
Contacting Agilent	23
Section 1. Introduction to the Leak Detector	25
1.1 The Leak Detector	25
1.2 Unpacking the Leak Detector.....	28
1.2.2 Unpacking, Initial Startup, High Pressure Test Setup, and Shutdown.....	28
1.3 Installation.....	34
1.3.3 Bench System Installations.....	35
1.3.2 Recommended Additional Services	36
1.3.3 Storage.....	37
1.3.4 Startup.....	37
1.3.5 Turn Off (Shutdown).....	40
1.4 Front Panel Display and Operations	41
1.5 Home Screen	43
1.6 Front Panel Display - Home Screen Display.....	45
1.7 Rear Panel	48
1.8 Features.....	51
Section 2. Operating the Leak Detector	53
2.1 Screens	53
Section 3. Home Screen	55
3.1 Home Screen	55
3.1.2 Menus Screen.....	63
Section 4. Calibration Screen	65
4.1 Calibration Set-Up	65
Section 5. Test Configuration Screen	69
5.1 Test Configuration	69
5.1.2 Test Configuration Advanced Features.....	72
5.1.3 Application Setup	78
Section 6. Settings Screen	103
6.1 Settings Menu	103
6.2 Main Settings	104
6.2.2 Screen Settings.....	106
6.2.3 Analog Output	108
6.2.4 Remote Control.....	110
6.2.5 Password and Restrictions.....	111

Agilent Technologies Helium Leak Detector

6.3 Wireless	112
Section 7. Maintenance Screen	113
7.4 Maintenance Menu	113
7.4.2 Internal Calibrated Leak Setup	115
7.4.3 Manual Tuning	118
7.4.4 Maintenance: Valve Control	121
7.4.5 Maintenance: Pump	124
7.4.6 Maintenance: Gauge Calibration	125
Section 8. Unit Maintenance	131
8.1 Daily Maintenance	135
8.2 Dry Nitrogen Vent	135
8.3 Spare Parts List	136
8.4 Leak Detector Accessory Item List	138
Appendix A. Communications Protocol	139
A.2 Communicating with RS-232	140
A.2.1 Windows HyperTerminal Set-Up Instructions	140
A.2.2 Printing with HyperTerminal	142
A.3 Customer Accessible Inputs and Outputs	152
A.3.1 Serial Connector	152
A.3.2 I/O Connector	152
Appendix B. Introduction to Leak Detection	157
B.2 Agilent's Helium Leak Detection Technologies	157
B.3 Methods of Leak Testing	159
B.3.1 Vacuum Testing Method (Outside-in)	160
B.3.2 Pressure Testing Method (Inside-out)	161
B.3.3 System Leak Test Methods	162
B.4 Typical Leak Detection Applications	164
B.4.1 Quality Control of Production Parts and Assemblies	164
B.4.2 Maintenance of Systems	164
B.4.3 System Integrated Leak Detection	165
B.4.4 Mass Produced Parts	165
Appendix C. Specifications	167

List of Figures

Figure Title	Page
1-1 Portable Leak Detector with Internal DS40M Wet Rotary Vane Pump, Model G8610A, and Portable Leak Detector with Internal IDP-3 (G8610B) Dimensions	27
1-2 Mobile Leak Detector with External Wet Rotary Vane Pump or Dry Scroll Pump on a Cart, Model G8611A, G8611B and G8611C Dimensions.....	27
1-3 Remove from Skid	28
1-4 Leak Detectors Unboxed	29
1-5 Mobile Unit.....	29
1-6 Shipping Locks.....	30
1-7 IDP-15 Rear Pump Access	30
1-8 IDP-15 Shipping Locks Loosening.....	31
1-9 TS620 Shipping Locks Removal.....	31
1-10 Oil-based Pumps	32
1-11 DS40-M Oil Access.....	32
1-12 Mobile Unit Oil Fill	33
1-13 Bench Mount Leak Detector with External DS302/DS602 Wet Rotary Vane Pump, Model G8612A\GS8612D	35
1-14 Bench Mount Leak Detector with External TS620 Dry Scroll Pump, Model G8612.....	35
1-15 Bench Mount Leak Detector with External IDP-15 Dry Scroll Pump, Model G8612C	36
1-16 Helium Background Timer	39
1-17 Front Panel Displays and Operations	41
1-18 Home Screen	42
1-19 Screen Flow	44
1-20 Rear Panel	48
1-21 Rear Panel (with Discrete I/O PCB)	49
3-1 Home Screen	55
3-2 Main Menu Select	57
3-3 Power Off Dialog.....	57
3-4 Graphical Display.....	61
3-5 Menus Screen.....	63
4-1 Calibration Set-Up.....	65
4-2 20 Minute Warm-up Dialog	66
4-3 Helium Background Timer	68
5-1 Reject and Audio Setpoints.....	70
5-2 Test Configuration Screen	72
5-3 Gross Test Screen	74
5-4 Transfer to Test.....	75
5-5 Home Screen - Activate Gross Test	77
5-6 Home Screen - Gross Test Active	78
5-7 Application Setup	78
5-8 Sniff Method.....	79
5-9 Spray Method.....	81

Agilent Technologies Helium Leak Detector

5-10	High Sensitivity	83
5-11	Auto Sequencer	86
5-12	Split Flow Application.....	89
5-13	Split Flow Setup.....	91
5-14	PPM Sniff Method.....	92
5-15	Sniffing Setup	93
5-16	Metering Valve Overall Assembly	95
5-17	Metering Valve Assembly	95
5-18	External Sniff Calibration Setup.....	96
5-19	Alicat Scientific Mass Flow Meter Supported Method of PPM Testing	97
5-20	Hose Fitting Connection	97
5-21	Re-purposing a Power Probe for Thin Hose Without a Regulator	98
5-22	External Sniff Calibration Setup.....	99
5-23	Compression Port	100
5-24	Probe Configuration.....	100
6-1	Settings: Main Settings	104
6-2	Date and Time	105
6-3	Settings: Screen Settings	106
6-4	Leak Detector Linear Output Voltage	109
6-5	Leak Detector Logarithmic Output Voltage.....	109
6-6	System Settings: Remote Settings	110
6-7	Systems Settings: Password and Restrictions	111
7-1	Maintenance General	113
7-2	USB Port.....	114
7-3	Insert USB Drive	114
7-4	Internal Calibrated Leak.....	115
7-5	Internal Calibrated Leak Keypads.....	116
7-6	Calibrated Leak.....	117
7-7	Manual Tuning.....	118
7-8	Maintenance: Valve Control.....	121
7-9	Valve Control Models G8610B, G8611B, G8611C, G8612B & G8612C	121
7-10	Leak Detector Vacuum System Diagram.....	123
7-11	Maintenance: Fore Pump	124
7-12	Maintenance: Gauge Calibration	125
7-13	Maintenance: System Defaults	126
7-14	System Information.....	127
7-15	Current Setup Screen	128
7-16	Power Off.....	129
7-17	Power Off.....	130
7-18	Power Off Confirmation	130
8-1	Dry Nitrogen Vent	135
A-1	Serial Connector Map	152
A-2	Optically Isolated Output Circuit Sketch	155
A-3	Optically Isolated Input Circuit Sketch	156
B-1	Magnetic Separation Principle	158
B-2	Selective Ion Pump Detector	159

Agilent Technologies Helium Leak Detector

B-3	Locating Leaks: Outside In	160
B-4	Measuring Leaks: Outside In	160
B-5	Measuring Leaks: Inside Out	161
B-6	Locating Leaks: Inside Out	161
B-7	Accumulation: Inside Out	162
B-8	Vacuum System.....	163

This page intentionally left blank.

List of Tables

Table	Title	Page
1-1	Series Leak Detector Configurations and Part Numbers	26
1-2	Installation Requirements	34
1-3	Screens – General Description	45
1-4	Features	51
2-1	On-Screen Icons	53
3-1	Leak Detector Operating States	58
3-2	Leak Detector Condition States	58
6-1	Range Stop/Sensitivity Requirements	107
7-1	Leak Detector Valve State Table - Single Mechanical Pump System	122
7-2	System Information Screen Conditions	127
7-3	Current Setup Screen Conditions	128
8-1	Scheduled Maintenance	133
8-2	As-Required Maintenance	133
8-3	Fuses and Circuit Breakers	134
8-4	Leak Detector Spare Parts	136
8-5	Primary Pumps Replacement Parts	137
8-6	Leak Detector Accessory Item List*	138

This page intentionally left blank.

Preface

Documentation Standards

This manual uses the following documentation standards:



Notes contain important information.















Cautions appear before instructions, which if not followed, could cause damage to the equipment or data loss.



Warnings appear for a particular procedure or practice which, if not followed correctly, could lead to serious injury or death.

Hazard and Safety Information

The common international symbols used in this manual and on the equipment are defined below.

	OFF Supply (Power)		Earth (Ground) Terminal
	ON Supply (Power)		Caution, Hot Surface
	AC – Alternating Current		Caution, Risk of Electrical Shock
	Warning, Risk of danger*		Protective Conductor Terminal
	Frame or chassis Terminal		Do Not Place in Trash
	Indoor, Dry Location Use Only		Caution, Radio Restriction

Operators and service personnel must be aware of all hazards associated with this equipment. They must know how to recognize hazardous and potentially hazardous conditions, and know how to avoid them. The consequences of unskilled, improper, or careless operation of the equipment can be serious. Every operator or service person must read and thoroughly understand operation/maintenance manuals and any additional information provided by Agilent. All warning and cautions must be read carefully and strictly observed. Consult local, state, and national agencies regarding specific requirements and regulations. Address any safety, operation, and/or maintenance questions to your nearest Agilent office.

* The warning messages are for attracting the attention of the operator to a particular procedure or practice which, if not followed correctly, could lead to serious injury.

Solvents

WARNING



The mechanical components of leak detectors are typically cleaned with alcohol, methanol, or other solvents.

When heated, sprayed, or exposed to high-temperature equipment, these solvents become flammable and explosive, causing serious injury or death. Do not use these solvents near a high-temperature source. Ventilate the working area with a blower and work in a large, well-ventilated room.

Alcohol, methanol, or other solvents are irritants, narcotics, depressants and/or carcinogens. Their inhalation and/or ingestion may produce serious side effects. Prolonged or continued contact with the skin results in absorption through the skin and moderate toxicity. Always ensure that cleaning operations are carried out in large, well-ventilated rooms, and wear eye shields, gloves, and protective clothing.

To clean the leak detector enclosure and the Touch Panel display use only a soft cloth slightly dampened with water or a mild soap.

Do NOT use excess water or cleaning solvents of any kind.

Avoid splashing any cleaning solvents into the unit through the ventilation openings or Front Panel buttons. Wipe the surface with a dry lint-free cloth.

CAUTION



Do not clean any aluminum parts with Alconox[®]. Alconox is not compatible with aluminum and will cause damage.

Vacuum Equipment and Cleanliness

Cleanliness is vital when servicing the leak detector or any vacuum equipment. There are some techniques that are more important in leak detector servicing than in general vacuum work:

CAUTION



Do not use silicone oil or silicone grease.

Use powder-free butyl or polycarbonate gloves to prevent skin oils from getting on vacuum surfaces.

NOTE



Agilent does not recommend the use of vacuum grease. Vacuum grease absorbs helium tracer gas and releases this slowly resulting in helium background during leak test operations. If it must be used, use it sparingly and avoid silicone types. Apiezon[®] L grease is recommended (Agilent Part No. 695400004).

O-ring Care

When removing, checking or replacing O-rings, keep in mind the following:



Agilent recommends replacing all O-rings during routine maintenance or during any maintenance procedure requiring that O-rings be removed.



Due to the effective cleaning nature of VacuSolv solvent and its residue-free properties, Agilent' Component and Spectrometer Cleaning Kit (Part Number 670029096), used in accordance with the kit instructions, is recommended for cleaning spectrometer components. The kit can also be used for fine cleaning of other parts in the leak detector's vacuum system such as valves and fittings. No rinsing steps or high-temperature drying are required following cleaning with VacuSolv. Although appropriate precautions are advised, VacuSolv is compatible with most materials and does not contain toxic chemicals or CFCs (chlorofluorocarbons). Other acceptable solvents are isopropyl alcohol (IPA) or Dow Corning[®] OS-20.

CAUTION



Remove O-rings carefully with your fingers. Do not use metal tools for this task; this prevents scratching of any sealing surfaces.

- Wipe all O-rings clean with a lint-free cloth before installation to ensure that no foreign matter is present to impair the seal.*
- Do not use grease or any other substance on O-rings that will come in contact with the spectrometer.*
- Do not use alcohol, methanol or other solvents on O-rings. Doing so causes deterioration and reduces their ability to hold a vacuum.*
- Agilent does not recommend the use of vacuum grease. If applicable, apply a small amount of Apiezon[®] L grease and wipe the O-rings shiny dry.*

Metal Seal Care

CAUTION



Metal Seals must be replaced during routine maintenance or during any maintenance procedure required. All fasteners must be installed and torqued per assembly procedure specifications. Remove Metal Seals carefully with your fingers. Do not use metal tools for this task, this prevents scratching of any sealing surfaces. Wear non-powdered, ESD safe Nitride or equivalent gloves prior to removing or replacing Metal Seals.

- All Metal Seals come in clean room condition packages. No cleaning is required. If necessary, Metal Seals can be cleaned using alcohol or methanol. Wipe all Metal Seals clean with a lint free cloth before installation to ensure that no foreign matter is present to impair the seal.*
- Do not use grease or any other substance on Metal Seals that will come in contact with the spectrometer.*

Equipment, General

Environment of intended use:

- Indoors use in an industrial and laboratory installation only.*
- Altitude up to 2000m*
- POLLUTION DEGREE 2, Material group III*
- Operating Temperature: +12 °C to +40 °C, Relative Humidity (RH) up to 90% max., non-condensing.*
- Storage ambient conditions: RH from 0% to 95%, non-condensing, temperature: -20°C to +60°C*

WARNING



- Do not use in presence of flammable or explosive gas.*
- Do not attempt to disassemble or modify the equipment. Such action could lead to electric shock or injury. Agilent's authorized technician will do any repair work.*
- If there is smoke or unusual smell or noise, stop the using the equipment immediately, and contact the Agilent Service Center.*

WARNING



The leak detector is not designed for use with hazardous gases. Verify that the system to be tested has been purged of all hazardous gases prior to using the leak detector. When testing a system that contained hazardous gases, connect the exhaust of the leak detector to a scrubbed or toxic containment exhaust. Exposure to hazardous gases could result in serious injury or death.

Agilent Technologies Helium Leak Detector

WARNING



Equipment tightness is guaranteed for normal operating conditions when the equipment leaves the factory. It is the user's responsibility to maintain the level of tightness, particularly when pumping dangerous products.

CAUTION



The performance and operating safety of this equipment can only be guaranteed if it is operated according to normal conditions of use.

Allow at least 2 to 3 feet of clearance adjacent to the slots at the front, sides and back of the equipment enclosure.

Allow sufficient room for the operator to safely maneuver to perform testing.

Touch Panel Display

CAUTION



Do not apply excessive pressure to the Touch Panel display as this may cause smears.

In general, the lower the temperature, the longer it takes the Touch Panel display to turn on. Performance of the Touch Panel display may deteriorate in low temperature.

Radio

The Wireless Remote Control and Base Board PCB are built around Laird's, model RM024, RF transceiver module operating in 2.4 GHz ISM band. The same type of the RF module is built in an Agilent Technologies Helium Mass Spectrometer Leak Detector Wireless Base Station PCB and Wireless Remote unit (see *Agilent Technologies Helium Mass Spectrometer Leak Detector Wireless Remote Operational Manual* (6999099945A)).

Agency Identification Numbers for Laird, Model: RM024 AC4424-100:

- US/FCC ID: KQL-RM024
- CAN/IC: RSS-210
- EUR/ETSI EN: CE
- Taiwan: CCAI13LP3400T1, CCAI13LP3330T3

are also applied to the Agilent's Wireless Remote and Agilent Technologies Helium Mass Spectrometer Leak Detector Wireless Base Station, when the units are used the approved antennas.

Agilent Technologies Helium Leak Detector

WARNING



The Wireless Remote complies with Part 15 of the FCC Rules. Operation is subject to the following two conditions: (1) This device may not cause harmful interference, and (2) This device must accept any interference received, including interference that may cause undesired operation.

To satisfy RF exposure requirements for mobile type transmitting devices, maintain a separation distance of 20 cm or more between the antenna of the Wireless Remote and persons during operation.

Maintain a separation distance of 20 cm or more between the operator and the RF antenna of the leak detector with a wireless base station.

CAUTION



Use only approved type of antennas for:

- Wireless Remote: Centurion, Model WCP2400-MMCX2, www.centurion.com.
- Agilent Technologies Helium Mass Spectrometer Leak Detector Wireless Base Station, Nearson, Model S181FL-5-RMM- 2450S, www.nearson.com

Power and Static Sensitivity

WARNING



Depending on the unit configuration ordered, the mains power supply requirements for Agilent Technologies Helium Mass Spectrometer leak detectors are:

- 100 VAC, 50 Hz, 5 A
- 115 VAC, 60 Hz, 5 A to 9 A (G8611A) or
- 230 VAC, 50/60 Hz, 3 A to 4 A

Before powering the unit for the first time, verify that the unit is configured to operate for the local mains supply voltage. Need nominal current for all models.

Agilent Technologies Helium Leak Detector

CAUTION



Use surge protection to improve the immunity of the leak detector against unidirectional transients caused by the following phenomena:

- Switching phenomena in the power network (e.g., switching of capacitor banks, inductive loads, electrical motors, etc.)
- Faults in the power network
- Indirect lightning strokes

CAUTION



Many components of the leak detector are static sensitive. Wear a grounding device when performing any maintenance on the leak detector, especially when performing maintenance of static sensitive parts, such as circuit boards and the spectrometer.

CAUTION



This equipment has been tested and found to comply with the limits for Class A digital device, pursuant to Part 15 of FCC Rules. These limits are designed to provide reasonable protection against harmful interference when it is operated in a commercial environment.

This equipment generates, uses, and can radiate RF energy, which if not installed and used in accordance with the instructional manual, can cause harmful interference to radio communications.

When this equipment is operated in a commercial environment, operation is subject to the following two conditions:

- This equipment must not cause harmful interference.
- This equipment must accept any interference received, including interference (RF and ESD) that may cause undesired operation.

The equipment may need to be reset after RF and/or ESD events by cycling the Power Switch/Circuit Breaker on the back panel of the unit.

Operation of this equipment in a residential area is also likely to cause harmful radio communications interference, in which case, the users will be required to correct the interference at their expense.

WARNING



CAN/CSA-C22.2 No. 61010-1-12 - Safety Requirements for Electrical Equipment for Measurement, Control, and Laboratory Use - Part 1: General Requirements

UL Std. No. 61010-1, 3rd Edition - Safety Requirements for Electrical Equipment for Measurement, Control, and Laboratory Use - Part 1: General Requirements

EMC Emissions and Immunity - ETSI EN 301 489-1 v2.2.0 (2017-03) Electromagnetic Compatibility and Radio Spectrum Matters (ERM); Electromagnetic Comparability (EMC) standard for radio equipment and services; Part1: Common technical requirements

- Any modifications on the part of the user are liable to cause non-compliance with regulations or affect the EMC performance and the safety of the product. Agilent cannot be held responsible for consequences resulting from such intervention.*
- Before powering the unit the first time, verify that the unit is configured to operate for the local mains supply voltage.*
- The equipment can be damaged by:*
 - Incorrect mains AC supply voltages*
 - Radio Frequency (RF) and Electrostatic Discharge (ESD) energy inputs that exceed the maximum ratings*
 - Operating in very high temperatures or without adequate ventilation*
 - Immersion in liquids*
 - Physical abuse*
- All electrical connections must be performed by a qualified electrician and must comply with national and local codes.*
- Opening the enclosure may expose hazardous voltages. Always disconnect the power cord and interface cables before opening the enclosure. Do not touch the power inlet's contacts for at least 10 seconds after disconnecting the power cord.*
- Electrical installation must include the appropriate branch circuit (20 A maximum), with a long time delay and a reliable earth ground.*
- Use only the power cord that was provided with your leak detector. The use of extension cords is not recommended and could result in damage to the equipment and loss of warranty.*
- To avoid electric shock, connect the product power cord to a grounded power receptacle. A power cord with a grounding conductor is required.*

Agilent Technologies Helium Leak Detector

- Allow an adequate distance (2 to 3') from the back of the leak detector to the power source. This ensures easy access to the power cord for connecting or disconnecting purposes.

Spectrometer

WARNING



Store the Ion Source/Preamplifier sub-assembly in a cool, dry area in a tightly sealed, ESD protected container. Wear lint-free gloves when handling the spectrometer. Wash hands thoroughly after handling the spectrometer filaments and especially before smoking or eating.

CAUTION



The spectrometer operates at a very high vacuum produced by the high vacuum pump. Service of the spectrometer requires that this vacuum be vented to the atmosphere.

CAUTION



Do not use grease or any other substance on O-rings or metal seals that will come in contact with the spectrometer.

CAUTION



If the spectrometer magnet comes in contact with a magnetic surface, the magnet can become degraded causing the spectrometer to lose sensitivity.

Pumps

WARNING



To avoid injury, use proper lifting techniques when moving pumps. Two people may be required to move pumps safely.

WARNING



The vacuum pumps are also compressors; incorrect operation may be dangerous. Study the Mechanical Pump Operation Manual enclosed with your pump before starting pumps.

The pumps are designed to prevent any thermal risk for user safety. However, specific operating conditions may generate temperatures $>70^{\circ}\text{C}$.

Hot oil burns the skin. Service of the pumps in this area must be performed by authorized personnel only. Stand back from a mechanical pump before starting it.

WARNING



To avoid injury, wait until the turbo pump is completely stopped before disconnecting it from the vacuum system.

*Check the oil level often. Do not allow oil-based mechanical pumps to run when the oil level is below the **LOW** mark.*

Damage to pumps can occur if operated with no oil, if the oil level is too high or if the oil has become discolored.

Agilent Services

Agilent offers:

- Rebuilt spectrometers on an exchange basis.
- NIST-traceable calibrated leak testing and verification services.
- Preventive maintenance services.
- Overhaul services.
- System recertification.
- Support agreements.
- On-site support.

Please see our catalog or contact us to learn about available services.

Contacting Agilent

In the United States, you can contact Agilent Customer Service at 1-800-882-7426. See the back cover of this manual for a listing of our sales and service offices.

Visit our web site at:

<http://www.agilent.com/en/products/vacuum-technologies>

For leak detector support agreements:

vpl-customer@agilent.com

<http://www.agilent.com/en-us/services/vacuum-product-services>

This page intentionally left blank.

Section 1. Introduction to the Leak Detector

1.1 The Leak Detector

The leak detector is a wide-range Helium Mass Spectrometer Leak Detector, which is comprised of a turbo molecular high vacuum pump, internal mechanical rough pump (model G8610A), internal scroll pump (model G8610B), external mechanical rough pump (models G8611A, G8611B, G8611C, G8612A, G8612B, G8612C and G8612D), spectrometer tube, valve block, leak detector electronics, an operator interface (TFT-Touch Panel display and optional features, including:

- ❑ Wireless remote control that includes:
 - ❑ Wireless Base PCB (P/N G8600-68001) installed in a leak detector
 - ❑ Wireless Remote unit (P/N G8600-68002).
- ❑ Optional I/O PCB (P/N VSFLDIO).

Models G8611Ax, G8611Cx, G8611Bx and G8612D include an optional four-wheel cart.

All models are available in 100/115 VAC and 230 VAC configurations (see Table 1-1 on page 26).

The wireless remote control has the following capabilities:

- ❑ RF communication between Agilent Technologies Helium Mass Spectrometer leak detector (Base Station or Host) and the Wireless Remote unit from the distance up to 100 m (300 ft).
- ❑ Enter the leak detector unit into Test and Hold modes from the Wireless Remote unit keypad.
- ❑ Read the leak detector unit's leak rate in a linear and logarithmic bar graph format with a numeric range indicator and System status in alphanumeric format on the Wireless Remote unit Touch Panel display.
- ❑ Configure up to ten different Agilent Technologies Helium Mass Spectrometer leak detector units for wireless control by toggling through a MAC address list using one Wireless Remote unit.

The optional I/O PCB comprises:

- ❑ Optically isolated parallel I/O (DB25 female connector with 12 output and 8 input lines) to use with an external PLC and should be powered by the user (+5-24 VDC) via a cable with length less than 10' and provided by the user (see Appendix A.3.2 "I/O Connector" on page 152).

Agilent Technologies Helium Leak Detector

CAUTION



The usage of a longer cable for the parallel I/O output connection with an external PLC is fully responsibility of the user. Some EMC prevention measure may be required by the user.

- USB type A connector and one located on the back of the leak detector.

NOTE



USB features are for updated software downloads only.

Table 1-1 Series Leak Detector Configurations and Part Numbers

Model Number	Leak Detector Type	Agilent P/N	Mains Voltage	50/60 Hz (Amp)
G8610A (DS40M)	Portable	G8610-64000	115 VAC	2.0/2.3
	Portable	G8610-64001	230 VAC	1.0/1.3
G8610B (IDP-3)	Portable	G8610-64002	100 VAC	2.2/2.4
	Portable	G8610-64003	115 VAC	2.4/2.2
	Portable	G8610-64004	230 VAC	1.2/1.2
G8611A (DS302)	Mobile	G8611-64000	115 VAC	9.0/5.4
	Mobile	G8611-64001	230 VAC	4.4/2.5
G8611B (TS620)	Mobile	G8611-64002	115 VAC	7.7/6.8
	Mobile	G8611-64003	230 VAC	3.8/3.4
G8611C (IDP-15)	Mobile	G8611-64004	115 VAC	6.0/4.2
	Mobile	G8611-64005	230 VAC	2.8/3.0
G8611D (DS602)	Mobile	G8611-64006	230 VAC	4.4/2.8
G8612A (DS302)	Benchtop	G8612-64000	115 VAC	9.0/5.4
	Benchtop	G8612-64001	230 VAC	4.4/2.5
G8612B (TS620)	Benchtop	G8612-64002	115 VAC	7.7/6.8
	Benchtop	G8612-64003	230 VAC	3.8/3.4
G8612C (IDP-15)	Benchtop	G8612-64004	115 VAC	6.0/4.2
	Benchtop	G8612-64005	230 VAC	2.8/3.0
G8612D (DS602)	Benchtop	G8612-64006	230 VAC	4.4/2.8

Outline drawings for each configuration are shown in Section 1.1.1 “Leak Detector Configurations”.

1.1.1 Leak Detector Configurations

This section contains outline drawings of the leak detector configurations. Dimensions are given in mm, below the brackets. Figure 1-1 shows the outline drawing and physical dimensions of the portable leak detector with Internal DS40M Wet Rotary Vane Pump, Model G8610A and the G8610B, which utilizes a Agilent IDP-3 dry pump.

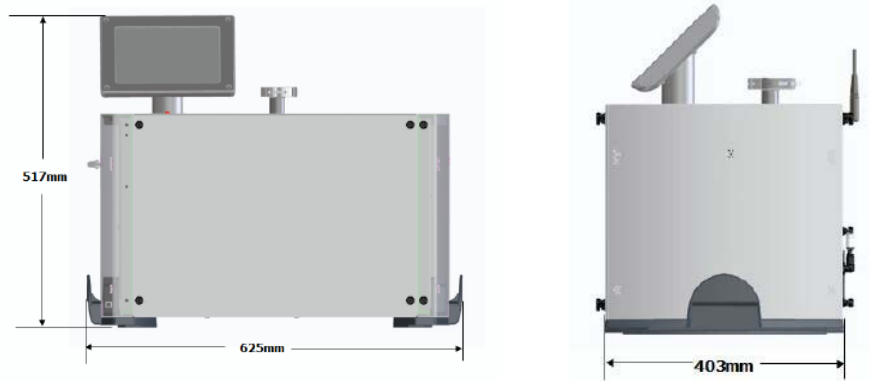

Figure 1-1 Portable Leak Detector with Internal DS40M Wet Rotary Vane Pump, Model G8610A, and Portable Leak Detector with Internal IDP-3 (G8610B) Dimensions

Figure 1-2 shows the outline drawing and physical dimensions of a mobile leak detector with Models G8611x.

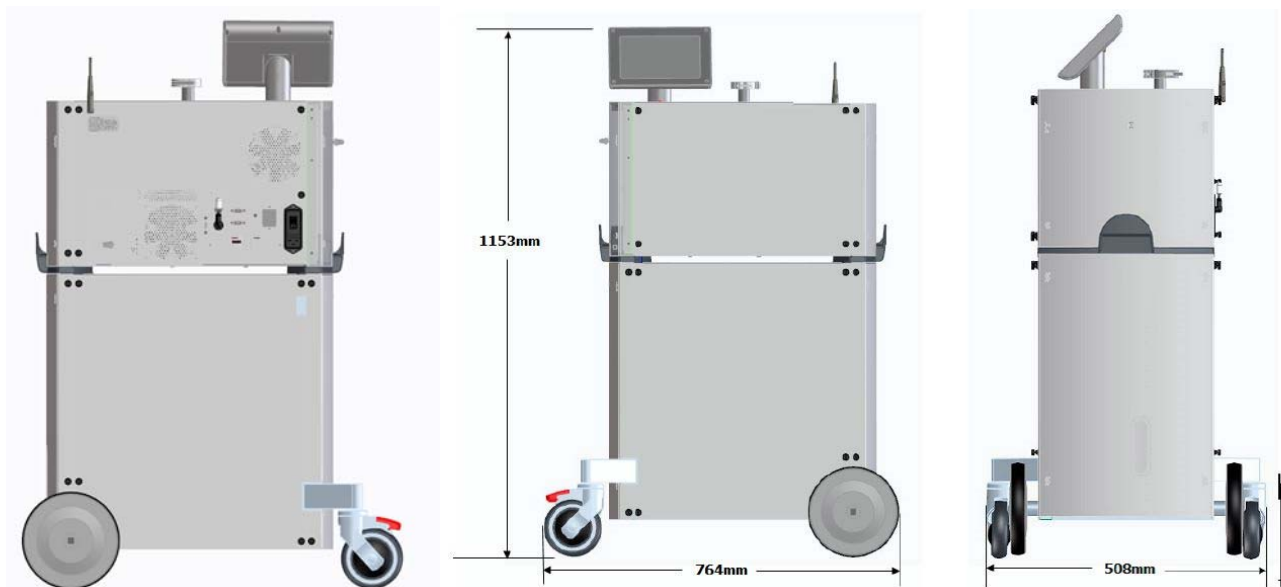

Figure 1-2 Mobile Leak Detector with External Wet Rotary Vane Pump or Dry Scroll Pump on a Cart, Model G8611A, G8611B and G8611C Dimensions

1.2 Unpacking the Leak Detector

The following items are included in the shipment:

- ❑ Agilent Technologies Helium Mass Spectrometer Leak Detectors Operations Manual
- ❑ Agilent Technologies leak detector configured and completely assembled as ordered
- ❑ All necessary power cords, as ordered
- ❑ Pump manuals (for the purchased configuration)
- ❑ Any optional equipment ordered
- ❑ Any manuals for optional equipment purchased

1.2.2 Unpacking, Initial Startup, High Pressure Test Setup, and Shutdown

1.2.2.1 Unpacking

WARNING



Unpacking the Leak Detector: Always work in a team of at least two people. Wear personal protective equipment (PPE), including gloves, boots, and a weight belt to avoid injury.

1. Remove from Skid

1. Take the entire skid and box to an open area. Remove the shipping straps and pull the cardboard box straight up, over the leak detector. Save the box and the skid in case you need to do a return shipment (Figure 1-3).



Figure 1-3 Remove from Skid

2. Examine the leak detector for damage (whether a mobile unit with cart and wheels, portable, or benchtop), and remove the remaining shipping straps and top plastic *shower cap cover* (Figure 1-4).



Figure 1-4 Leak Detectors Unboxed

3. Unpack a mobile unit with wheels by
 - a. Removing the foam protective padding, propping up leak detector, placed between the two sets of wheels by gently tilting the leak detector a few degrees sideways and pulling the foam out. *Keep castor wheels locked until specified to unlock them.*
 - b. Removing the wooden block preventing the castor wheels from moving by unscrewing the wing nuts (Figure 1-5). Set the wing nuts aside.



Figure 1-5 Mobile Unit

- c. Gently rolling the leak detector off skid.

Agilent Technologies Helium Leak Detector

2. Undo Shipping Locks

A leak detector with either an IDP-15 pump or a TS620 pump is shipped with *shipping lock* bolts to secure the pump during transit. Remove these shipping locks before powering on the leak detector to prevent excessive rattle and noise during operation (Figure 1-6).



Figure 1-6 Shipping Locks

1. Use a flat tip screwdriver to remove the side walls from the leak detector cart. Remove the panels and set aside.
2. For the:
 - IDP-15 model, also remove the rear panel of the cart, opposite of the handle to access the rear of the pump, opposite the pump cooling fan. If any, remove and file paperwork attached to the pump.



Figure 1-7 IDP-15 Rear Pump Access

Agilent Technologies Helium Leak Detector

Use the provided 4 mm T-handle Allen wrench to turn the locks clockwise to loosen; the IDP-15 ship locks only tighten/loosen, and are not removable (Figure 1-8).

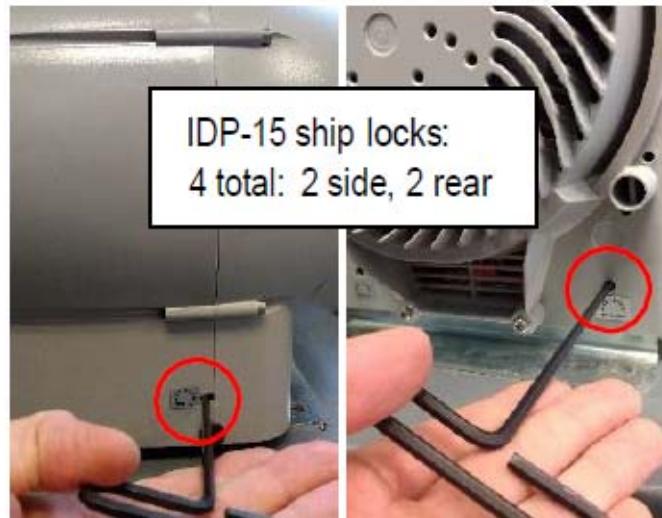

Figure 1-8 IDP-15 Shipping Locks Loosening

- ❑ For the TS620 pump, use a 10 mm driver to remove the shipping bolts (one on each side of the pump base) (Figure 1-9).

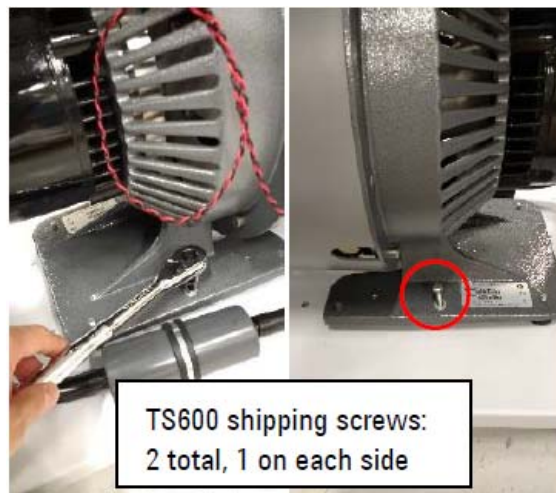

Figure 1-9 TS620 Shipping Locks Removal

Agilent Technologies Helium Leak Detector

3. Adding Oil

Oil rotary vane pumps must be filled with oil before operation. These include the DS40-M, DS302, and DS602 pump model leak detectors (Figure 1-10).



Figure 1-10 Oil-based Pumps

1. Use a funnel when adding oil, fill to the center of the sight glass marking.
2. For the:
 - ❑ DS40-M, open the top unit of the leak detector side away from screen (Figure 1-11).



Figure 1-11 DS40-M Oil Access

- ❑ Mobile units that require oil (DS302 and DS602) units, open the bottom cart and fill to middle of sight glass marking (Figure 1-12).



Figure 1-12 Mobile Unit Oil Fill



Powering Up

1. Ensure that the roughing pump is switched on and if applicable (IDP-15), set to the correct voltage setting.
2. Switch the leak detector on, cover the leak detector inlet with a blank-off cap (provided and already in place), and wait for the screen to read *System Ready* before operating.

1.3 Installation

Installation requirements are described in Table 1-2.

Table 1-2 Installation Requirements

Item	Requirement
Leak Detector Location	<ul style="list-style-type: none"> <input type="checkbox"/> Close to its power source. <input type="checkbox"/> Two to three feet clearance for proper ventilation. <input type="checkbox"/> Sufficient room for the operator to safely maneuver to perform testing. <p>NOTE  <i>Additional ventilation requirements for your specific application are discussed in Section 1.3.2 "Recommended Additional Services" on page 36.</i></p> <p>NOTE  <i>When installing a bench system with a mechanical pump, the power cord for that pump, if connected to the back of the leak detector, cannot exceed three meters. Additionally, connect the mechanical pump to the leak detector using the shortest possible vacuum connection to maximize vacuum performance.</i></p>
Power	See Table 1-1 on page 26.
Mains Supply Voltage Fluctuations	Must not exceed $\pm 10\%$ of the nominal voltage.
Pollution	Pollution Degree 2 per EN61010-1 Standard.
Fixed Mains Socket Outlet	Connect to a building protective earthing system.

1.3.3 Bench System Installations

Figure 1-13 and Figure 1-17 represent the process for installation of the bench system version of the Agilent Technologies Helium Mass Spectrometer Leak Detector.

Figure 1-13 is a drawing of a Bench Mount Leak Detector with External DS302 Wet Rotary Vane Pump, Model G8612A with individual components shown.



Figure 1-13 Bench Mount Leak Detector with External DS302/DS602 Wet Rotary Vane Pump, Model G8612A/GS8612D

Figure 1-14 is a drawing of a Bench Mount Leak Detector with External TS620 Dry Scroll Pump, Model G8612B with individual components shown.*



Cut the 3/4" black tubing into two equal parts as shown.



Note orientation of VPI valve

Figure 1-14 Bench Mount Leak Detector with External TS620 Dry Scroll Pump, Model G8612B

Figure 1-15 is a drawing of a Bench Mount Leak Detector with External IDP-15 Dry Scroll Pump, Model G8612C with individual components shown.

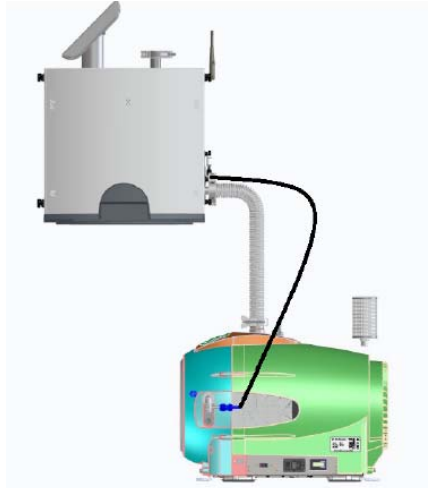

Figure 1-15 Bench Mount Leak Detector with External IDP-15 Dry Scroll Pump, Model G8612C

1.3.1 Helium

Welding grade helium in a standard cylinder with pressure regulating valve and hose is required for testing products and leak checking.

1.3.2 Recommended Additional Services

The following additional services are recommended, based on the application:

- ❑ Connect an exhaust hose to the foreline pump and vent it outside of the room, or to the facility's exhaust, to reduce the particulate count and the helium background signal.
- ❑ When using oil lubricated mechanical pumps, use an oil mist eliminator on the exhaust port of the mechanical pump to reduce the oil mist from the exhaust.
Oil mist eliminators can, however, become saturated with oil causing slower pumping speeds and higher helium backgrounds in the leak detector. The replacement time interval of the oil mist eliminator is determined by whether the user frequently operates at elevated roughing pressures, pumps on large volumes, or frequently cycles the system. Refer to Table 8-4 on page 136 and Table 8-6 on page 138 for the mist eliminator and replacement cartridge part number.
- ❑ Dry nitrogen vent to keep the test port dry. Refer to Section 8.2 on page 135 for more information.
- ❑ Adequate circulation to prevent an increased helium background level.

1.3.3 Storage

If the leak detector is not used immediately, it can be stored as received without special precautions. A dry, relatively dust-free area is preferred. The required environmental conditions for storage are:

- ❑ 0% to 95% relative humidity, non-condensing
- ❑ -20 °C (-4 °F) to + 60 °C (+ 140 °F) ambient temperature

CAUTION



Never leave the AA batteries in the Wireless Remote unit if it is will not be in use for a long period of time.

1.3.4 Startup

To start the leak detector:

1. Plug the leak detector power cord into an appropriate mains supply receptacle.
2. Move the power switch on the rear power control panel to the **I** position. If you have a bench system with a separate backing/roughing pump, turn the pump on. The Test button is disabled on start up until *System Ready* appears on the Home screen.

Once the leak detector boots up a startup wizard appears on the touch panel display allowing you to change the time and language.

3. Select choice of language, time/type (AM, PM & 24) and system setup.

The *System Ready* indication appears on the Home screen. If the leak detector is being started after a long period of being off (several hours), it can take up to five and a half minutes to stabilize and provide reliable, quantitative leak rate readings.

4. The leak detector is capable of performing an automated calibration routine using either an internal calibrated leak (factory installed), or an external calibrated leak placed into the system test port. Refer to Section 4.1 “Calibration Set-Up” on page 65 to properly set-up the leak detector for auto-calibration.



If the system was recently calibrated before shut down, it can be used for qualitative testing. Read the standard leak to verify accuracy. For more accurate quantitative leak values, perform a calibration 20 minutes after start-up.

To accurately read in the most sensitive decades (E-10 and E-11), warm up the leak detector for at least one hour prior to performing a full calibration. When leak checking in the E-9 atm-cc/sec range or higher, you can use the leak detector prior to one hour and verify system performance by assuring that the system can accurately read the internal calibrated leak.

The system is shipped from Agilent with the Minimum Range function turned ON and the bottom range set at the E-10 range (atm-cc/sec). To accurately test in the E-11 range, careful control of materials and the environment is required, consult a Agilent sales engineer for support.

5. Execute a calibration routine:
 - a. Press **Test** on the front panel to place the system in test mode.
 - b. Select **Menu Tab** on the Home screen.
 - c. Select **Calibration** option.
 - d. Press **Calibrate with Internal Leak Mode: Full**.

The system performs an automated internal calibration of the system.
 - External leak:
 - a. Press **VENT** to vent the leak detector and then install a calibrated leak into the system test port and press **TEST** on the *Home* screen.
 - b. Select **Calibration** option from the *Menus* selection.
 - c. Press Calibrate with **External Leak: Defaults fast only**.
 - d. Enter external calibrated leak value.
 - e. Press **Calibrate** to perform an automated calibration. Press **OK** to return to the *Home* screen.

For calibration in the E-10 range, the vacuum system must be sufficiently pumped to reduce helium background below the E-10 range signal level. This is required to achieve an acceptable signal-to-noise level and ensure accurate calibration.

E-10 range calibration is performed using an external calibrated leak. If an external calibration is selected soon after system startup, the system evaluates the helium background and determines if the background signal is sufficiently low to give an accurate calibration. If the:

- System has pumped out sufficiently, the calibration proceeds.
- Background is changing, indicating the system is still pumping away background helium, a countdown timer appears (Figure 1-16). The system monitors the helium

Agilent Technologies Helium Leak Detector

background and shows the time until the calibration begins. Should you prefer not to wait, a *Cancel* button permits the calibration request to be canceled.



The firmware initially starts at a large time interval, but recalculates the required time as the pumping continues. The new time is reflected on the timer.



Test Configuration Menu > Applications Setup > High Sensitivity automates and walks you through the E-10 External Calibration procedure.

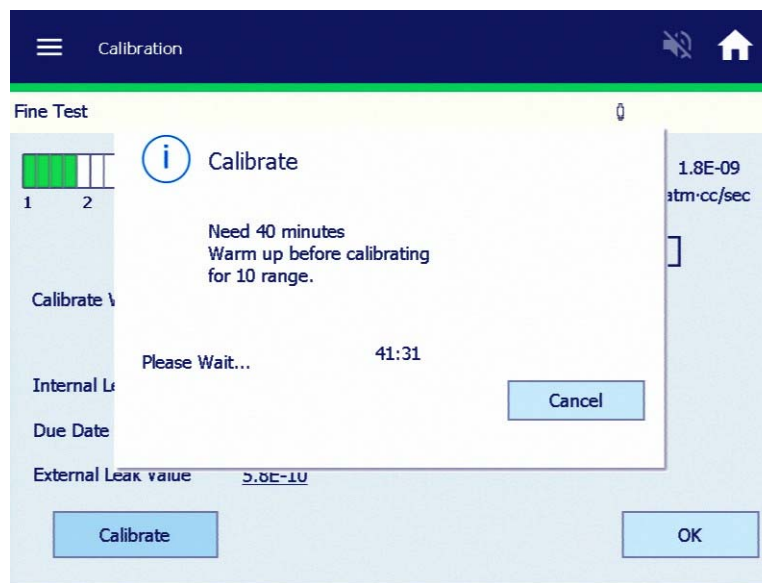

Figure 1-16 Helium Background Timer



When calibration is complete, the leak detector reverts to Fine Test mode.

1.3.5 Turn Off (Shutdown)

The system can be in any mode when shut down. When the system is shut down, all valves in the system close. If the system is not in Vent mode, the test port remains under vacuum and may be difficult to open.

To do a shutdown:

CAUTION



A soft power shut down (CPU and Electronics and Turbo Pump) is highly recommended before shutting off the main power switch (circuit breaker).

1. Go to the **Menu Tab**.
2. Select **Turn Off**.

NOTE



Do not turn off the main power switch until the power down status bar is complete and final power off message is accepted (OK).

To do a hard shut down of the leak detector for 24 VDC power supply and primary pump:

- Move the power switch on the rear panel to the **○** position.

1.4 Front Panel Display and Operations

All operator control and monitoring are achieved via the resident software accessed using the Touch Panel Display. Table 1-3 on page 45.



Figure 1-17 Front Panel Displays and Operations

Agilent Technologies Helium Leak Detector

- Touch Panel Display Represents:
- ❑ Leak Rate - in a Bar Graph format with a numeric range indicator
 - ❑ Leak Rate, System Status and Parameters - in alphanumeric format
 - ❑ Series of screens with the soft key buttons for operator interface

Leak Rate, System Status and Parameters in alphanumeric format:

- ❑ Leak Rate is presented in a scientific notation: $XXE-YY$ with appropriate units
Where: X .X mantissa is a leak rate value
E- Y = 10^{-YY} exponent is a leak rate range
X and Y are any numbers from 0 to 9
- ❑ System Status and/or Mode are represented on the screen in alpha format on the screen and an italic font in this manual
- ❑ Parameters are represented on the screen in alphanumeric format a bold font in this manual.

Leak Rate Bar Graph The large bar graph displays the leak rate in one of three forms:

- ❑ A linear bar graph
- ❑ A logarithmic bar graph

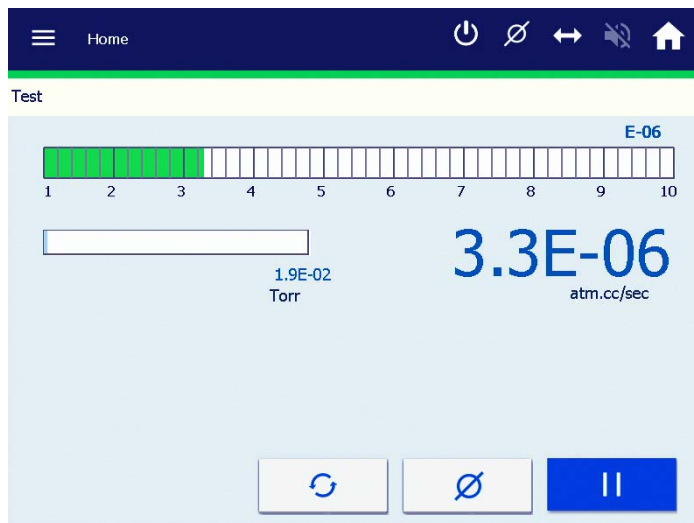

Figure 1-18 Home Screen

1.5 Home Screen

VENT	The VENT button advances the leak detector to the vented state. The red vent symbol in the middle of the switch remains red while the leak detector is in Vent.
TEST	<p>When the system is in the Vent or Hold states, pressing the TEST button automatically advances the leak detector through roughing, then through the various test states, depending on the achievable test port pressures and leak rates.</p> <p>Press the TEST button while in TEST to isolate the test port from the leak detector vacuum system.</p>
HOLD	With the leak detector in Test/Fine Test mode, press TEST again and the leak detector goes into HOLD mode, isolating the leak detector from the unit under test.

Agilent Technologies Helium Leak Detector

The leak detector operator interface functions through a series of screens, which are navigated as in Figure 1-19.



Figure 1-19 Screen Flow

1.6 Front Panel Display - Home Screen Display

Table 1-3 Screens – General Description

Screen	Purpose
Home	Accesses the Menu screens. Activates the Test, Vent and Zero functions. Activates the Gross Leak Test screen, when Gross Test is initiated via the Zero button.
Home (Menu Bar)	Activates/deactivates: <ul style="list-style-type: none"> <input type="checkbox"/> Power on/off (soft shut down) <input type="checkbox"/> Zero Enable <input type="checkbox"/> Graph Mode <input type="checkbox"/> Speaker Volume <input type="checkbox"/> Application in Use <input type="checkbox"/> Home Screen Icon

Agilent Technologies Helium Leak Detector

Table 1-3 Screens – General Description (Continued)

Screen	Purpose
Menus	<p>Accesses the following screens for tailoring leak detector operation:</p> <p>Calibration</p> <ul style="list-style-type: none"> <input type="checkbox"/> Internal or External selection <input type="checkbox"/> Read Internal Leak <input type="checkbox"/> Cal Leak information <p>Test Configuration</p> <ul style="list-style-type: none"> <input type="checkbox"/> Set Points - Configures: <ul style="list-style-type: none"> <input type="checkbox"/> Reject & Audio Set Points - Configures parameters and toggles operations on/off for each reject set point and for the audio threshold. <input type="checkbox"/> Advanced Features - Activates: <ul style="list-style-type: none"> <input type="checkbox"/> High Pressure Test <input type="checkbox"/> Fine Test Only <input type="checkbox"/> Auto-Zero<0 <input type="checkbox"/> Gross Test <input type="checkbox"/> Transfer to Test <input type="checkbox"/> Stabilization Wait <input type="checkbox"/> Application Setup - Activates: <ul style="list-style-type: none"> <input type="checkbox"/> Sniff Method <input type="checkbox"/> Spray Method <input type="checkbox"/> High Sensitivity <input type="checkbox"/> Auto Sequencer <input type="checkbox"/> Split Flow <input type="checkbox"/> PPM Sniff Method <p>Settings</p> <ul style="list-style-type: none"> <input type="checkbox"/> Main - Configures: <ul style="list-style-type: none"> <input type="checkbox"/> Date & Time <input type="checkbox"/> Leak Rate & Pressure Units <input type="checkbox"/> Language <input type="checkbox"/> Touch Sound Activation <input type="checkbox"/> Screen Settings - Configures: <ul style="list-style-type: none"> <input type="checkbox"/> Bar Graph Selection <input type="checkbox"/> Range Selection <input type="checkbox"/> Analog Output Selection <input type="checkbox"/> Remote Control - Configures: <ul style="list-style-type: none"> <input type="checkbox"/> Activation <input type="checkbox"/> Channel Selection <input type="checkbox"/> Password Restrictions - Configures <ul style="list-style-type: none"> <input type="checkbox"/> Restriction Level Selections <input type="checkbox"/> Lock and Vent Control

Table 1-3 Screens – General Description (Continued)

Screen	Purpose
	<p><i>Maintenance</i></p> <ul style="list-style-type: none"> <input type="checkbox"/> General - Configures: <ul style="list-style-type: none"> <input type="checkbox"/> Internal Calibrated Leak Setup & Expiration <input type="checkbox"/> Software Update Utility <input type="checkbox"/> Manual Tuning - Configures: <ul style="list-style-type: none"> <input type="checkbox"/> Toggles between Filament 1 & 2 <input type="checkbox"/> Sets Emission, Ion and Gain settings <input type="checkbox"/> Valve Control - Configures: <ul style="list-style-type: none"> <input type="checkbox"/> Access to control and monitor valves <input type="checkbox"/> Monitor turbo pump parameters <input type="checkbox"/> Pump - Configures: <ul style="list-style-type: none"> <input type="checkbox"/> Fore Pump description type, operating hours and <i>Last Service Date</i> <input type="checkbox"/> Enable Exhaust Pump <input type="checkbox"/> Gauge Calibration - Configures: <ul style="list-style-type: none"> <input type="checkbox"/> Calibrates the Test Port TC's Vacuum and ATM reference points <input type="checkbox"/> Displays Test port and spectrometer pressures <input type="checkbox"/> System Defaults - Configures: <ul style="list-style-type: none"> <input type="checkbox"/> Ability to reset Turbo and Filament hours for maintenance purposes <input type="checkbox"/> Ability to reset back to Factory Defaults <p><i>System Information:</i></p> <ul style="list-style-type: none"> <input type="checkbox"/> Displays part number and serial number <input type="checkbox"/> Display Software Version <input type="checkbox"/> Displays the status of the spectrometer and turbo pump parameters <input type="checkbox"/> Current Setup <input type="checkbox"/> Displays the status of active items

1.7 Rear Panel

The rear panel of the leak detector (models G8610A and G8612B) with the wireless remote control option is shown in Figure 1-20.

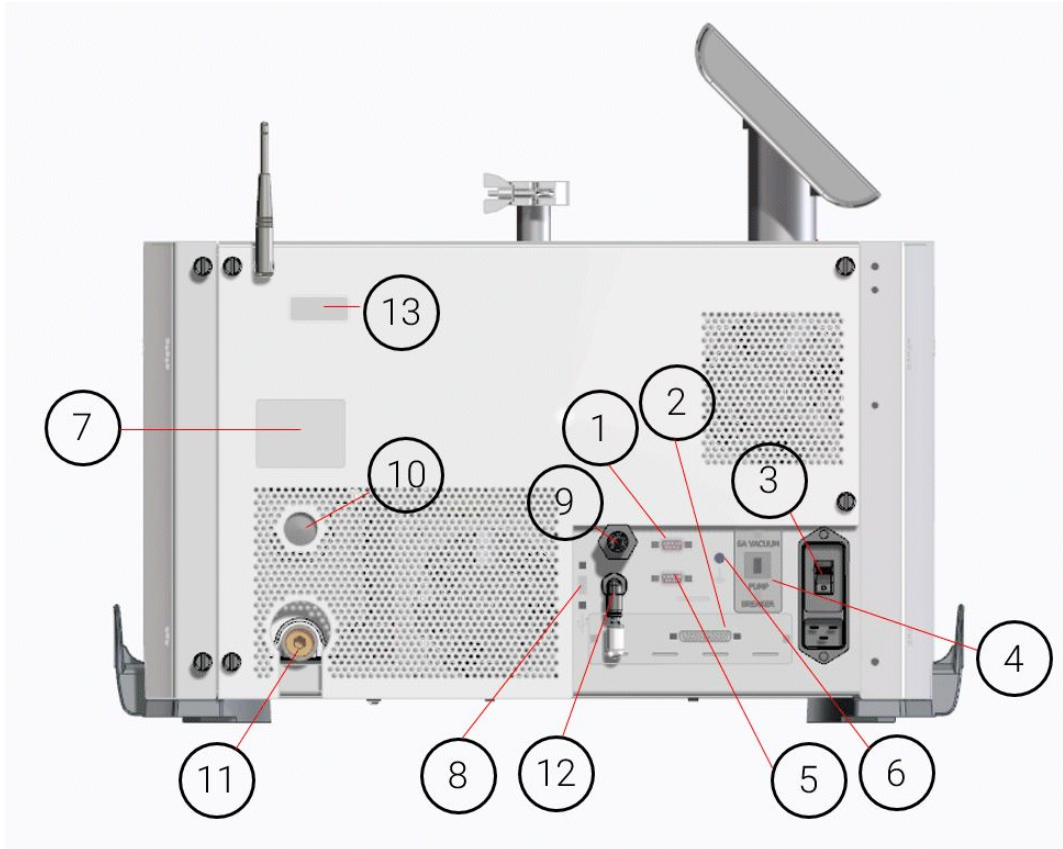

Figure 1-20 Rear Panel

- ① Serial Connector A 9-pin male D-type connector to interface with an external PC via RS-232 type communications protocol for system diagnostic or control.
A detailed summary of information related to serial communication is provided in Section A “Communications Protocol” on page 139.
- ② Cover Plate or I/O PCB Access to expansion slot. This is not used when an optional I/O PCB is installed. A rear panel of the optional I/O PCB is shown in Figure 1-21 on page 49.

Agilent Technologies Helium Leak Detector

- | | |
|----------------------------|--|
| ③ Power Entry Module | Provides supply power, overcurrent and EMI protection for the leak detector. The Power Entry Module consists of: <ul style="list-style-type: none">❑ Power Input Connector - An IEC/EN60320/C20 standard, three-prong grounded Inlet connector.❑ Power Switch (I/O) - A 20A rocker type Power Switch/Thermal Circuit Breaker.❑ 20 A EMC line filter. |
| ④ Vacuum Pump Breaker | A 6 A thermal circuit breaker for the internal foreline pump. |
| ⑤ Analog Output | DB9F connector for the analog output voltage. Pin #1 is signal (positive) and Pin #2 is return (negative). |
| ⑥ Chassis (Earth) Terminal | Provided for additional connection of the leak detector to the building grounding system to improve ESD protection. |
| ⑦ Product Label | A product label with part number, serial number and rating information. |
| ⑧ USB Port | A standard or high speed USB port for software updates. |
| ⑨ Exhaust | A barbed hose fitting (OD =12.57 mm) to exhaust the mechanical pump. |
| ⑩ Oil Level Cover | Oil level window for a G8610A model. |
| ⑪ Oil Drain Cover | Oil drain opening for a G8610A model. |
| ⑫ Nitrogen Vent Port | Nitrogen vent port. |
| Wireless Label | A wireless info label for leak detector with an optional Wireless Remote Control. |

The rear panel of the leak detector (Model G8610A and G8610B) is shown in Figure 1-21.

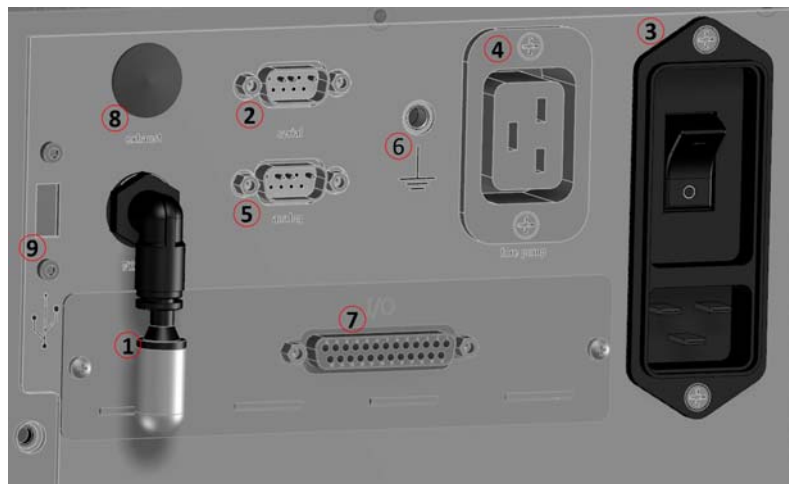

Figure 1-21 Rear Panel (with Discrete I/O PCB)

Agilent Technologies Helium Leak Detector

I/O Connector is a 25-pin female D-sub connector to interface with an external PLC via a parallel cable.

❑ Inputs:

- ❑ Four level inputs: optically isolated, (+5 to+24) VDC.
- ❑ Four momentary inputs: optically isolated, (+5 to+24) VDC, requires 200 ms pulse width.

All inputs are opto-isolator LEDs with a series 3300 Ohm resistor.

- ❑ Outputs: Eight optically isolated emitter followers with a 10 Ohm series resistor, 14 mA max drive current, +24VDC max.
- ❑ Power: An external power supply is supplied by the user.

A detailed summary of information related to I/O pin identifications is provided in Table A-6 on page 152.

① Nitrogen Vent Port

- ② Serial Connector A 9-pin male D-type connector to interface with an external PC via RS-232 type communications protocol for system diagnostic or control

A detailed summary of information related to serial communication is provided in Section A “Communications Protocol” on page 139.

③ Power Entry Module

Provides supply power, overcurrent and EMI protection for the leak detector. The Power Entry Module consists of:

- ❑ Power Input Connector - An IEC/EN60320/C20 standard, three-prong grounded inlet connector.
- ❑ Power Switch (I/O) - A 20A rocker type Power Switch/Thermal Circuit Breaker.
- ❑ 20 A EMC line filter.

④ Fore Pump Power Connection

An IEC/EN60320/C19 standard, three-prong grounded outlet connector.

⑤ Analog Output

The Agilent Technologies Helium Mass Spectrometer leak detector is equipped with a DB9F connector for the analog output. Pin #1 is signal (positive) and Pin #2 is return (negative). Signal range: From 0 to 10 VDC

⑥ Chassis (Earth) Terminal

Provided for additional connection of the leak detector to the building grounding system to improve ESD protection.

Agilent Technologies Helium Leak Detector

- ⑦ 25 Pin I/O
 - ❑ Inputs: Opto-isolated, 5 - 24 VDC 3300 Ohm resistive load. All inputs are opto-isolator LEDs with series resistors.
 - ❑ Momentary Inputs: Opto-isolated, 5 - 24 VDC 3300 Ohm resistive load, requires 200 ms minimum pulse width.
 - ❑ Outputs: Emitter follower with 10 Ohm series resistor, 14 mA max drive current, 24 VDC max.
For pin identifications, see Table A-6 on page 152.
- ⑧ Exhaust cover
- ⑨ USB Connector A standard or high speed USB port for software updates.

1.8 Features

The features for the leak detector are provided in Table 1-4.

Table 1-4 Features

Feature	Description
Calibration	Fully automated tuning and calibration using the internal or external calibrated leak. The fast calibrate feature allows calibration in less than one minute.
Zero Control	Selectable mode background elimination with a unique, patented Autozero<0 feature.
Leak Indication	A bar graph (linear or log) indicator displays leak rates automatically; alphanumeric indication on Touch Panel display. A leak can also trigger an audible alarm frequency that varies in proportion to the size of the leak, dedicated volume control and programmable audio threshold. Analog voltage is proportional to the leak rate.
Pressure Indication	Test port and spectrometer pressure with alphanumeric indication on the Touch Panel display.
Spectrometer	Sensitivity optimized design, header mounted ion source with dual thoria-coated iridium filament, a high sensitivity, wide dynamic range preamplifier, and vacuum gauge.
Automatic Valve Sequencing	Microprocessor-controlled valve operation provides automatic system cycling.
Safety Interlocks	A valve system design that completely protects the high vacuum system under test against pressure surge and power interruption.
Optional	

Agilent Technologies Helium Leak Detector

Table 1-4 Features (Continued)

Feature	Description
Wireless Remote Control	<p>This provides:</p> <ul style="list-style-type: none"> ❑ RF communication between the leak detector (with base station or host) and the Wireless Remote unit from a distance up to 100 m (300 ft). ❑ The ability to enter the leak detector unit into Test and Hold modes from the Wireless Remote unit's keypad. <hr/> <ul style="list-style-type: none"> ❑ The ability to read the leak detector's leak rate in a linear and logarithmic bar graph format with a numeric range indicator and System status in alphanumeric format on the Wireless Remote unit's Touch Panel display. ❑ Configuration up to 10 different leak detector unit's for wireless control by toggling through a MAC address list using one Wireless Remote unit
Discrete I/O Control	<p>This provides 12 outputs and 8 inputs lines, optically isolated, to control the leak detector using an external PLC via a 25-pin DB25 female connector and a user-provided parallel cable.</p>

Section 2. Operating the Leak Detector







2.1 Screens

The leak detector display is used for the initial set-up and configuration of the leak detector. Once the leak detector is set up and configured for a specific application, basic operation is controlled primarily using the **TEST** and **VENT** buttons on the leak detector and the Home screen Zero button (Section 3 “Home Screen” on page 55).

2.1.1 Basic Functions

Table 2-1 explains the icons that appear on various screens and their meaning.

Table 2-1 On-Screen Icons

Icon	Meaning
	Indicates a feature is locked and cannot be activated due to a higher level selection in the setup.
	Indicates the status of the internal calibrated leak: If flashing, the leak calibration will expire within 10 days. Steady and blue indicates that the leak has expired. Steady and red indicates a temperature sensor failure or a disconnected cable to the calibrated leak temperature sensor.
	Indicates the leak detector is in split flow.
	Indicates that the split flow leak rate being entered is greater than 1000 times the indicated leak rate; the maximum permitted.
	Indicates that the unit is in communication with a wireless remote unit.
	Indicates that the unit has detected a fault condition.

This page intentionally left blank.

Section 3. Home Screen

3.1 Home Screen

The Home screen displays a summary of the following status and configuration settings:

- Digital Leak Rate Display
- Test Port Pressure
- Gross Test button (not shown)
- Leak Detector Status (Table 3-1 on page 58)
- Condition Indication (Table 3-2 on page 58)
- Reject Status Indicator
- System Ready Indicator
- Menus button

Figure 3-1 shows the screen controls.

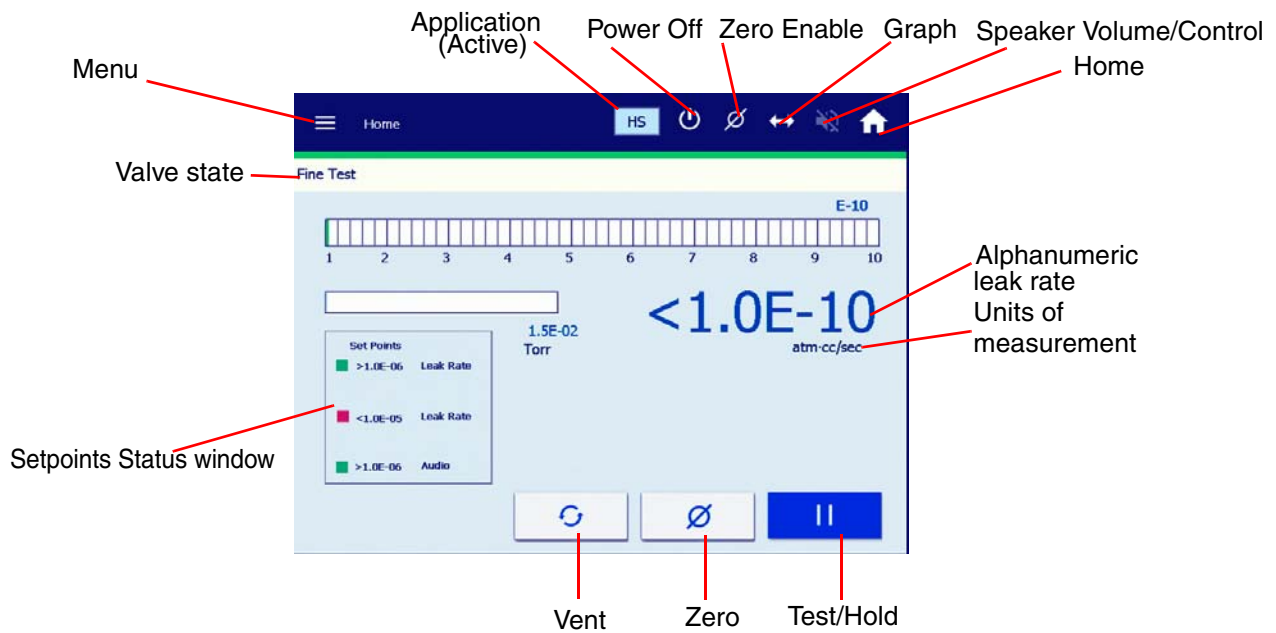

Figure 3-1 Home Screen

Agilent Technologies Helium Leak Detector

Hold	<p>Places the system in Hold (while in Test, press Test again to starts Hold); keeps the test port under vacuum and does not vent. Use Hold to keep the system under vacuum, while taking the leak detector out of test. This is useful if you want to let the leak detector clean up the helium background, while keeping the system under vacuum.</p> <p>Since the test port pressure gauge is located on the test port side of the isolation valve, a subsequent rise in test pressure can be observed while in this mode.</p>
Digital Leak Rate	<p>Correlates directly with the log and linear bar graph leak rate display. The units for the measurements are selected in the Settings > Main Settings menu (see Section 6.1 “Settings Menu” on page 103).</p>
Test Port Pressure	<p>Appears on the Home screen and represents the test port pressure as measured by a thermocouple device mounted on the valve block just below the test port. The pressure transducer and associated electronics are intended to protect the leak detector from damage due to over-pressure conditions. Use an external pressure transducer if the test process requires a more accurate monitoring of the test object pressure.</p>
Leak Detector Status	<p>Appears below the test port pressure reading and indicates the current leak detector operating state. The normal operating states are detailed in Table 3-1 on page 58.</p>
Leak Detector Condition	<p>Appears below the Leak Detector Status and indicates the current leak detector condition during abnormal conditions. See Table 3-2 on page 58 for a list of leak detector conditions.</p>
Setpoints Status Box	<p>Appears below the Leak Detector Condition on the left-hand center of the Home screen when any of the four independent set points are enabled and activated or de-activated.</p>
Zero	<p>Zeroes out the helium leak indicated on the display. The Zero button darkens while zeroing is taking place. The leak rate must be less than $4.0E-7$, while in Test, to allow a cross over to Fine Test.</p> <p>The Zero button is only active while the leak detector is in the Test and Fine Test states of operation.</p> <p>The leak detector automatically subtracts the recorded background signal to display only the real leak rate.</p>



Pressing Zero while introducing helium tracer gas to the test object or while the helium background is varying significantly could result in the suppression of a real leak. Only use the Zero button after the helium tracer gas source has been removed.

The Zero capability allows the testing of sensitivity levels that are below the system background. This feature also reduces test cycle times by reducing the amount of time required for background levels to naturally clean up or by allowing testing to begin at relatively high test pressures. It is recommended that only two decades of signal be zeroed out.

Menus

Displays the Menus screen (Figure 3-2) (Section 3.1.2 on page 63).

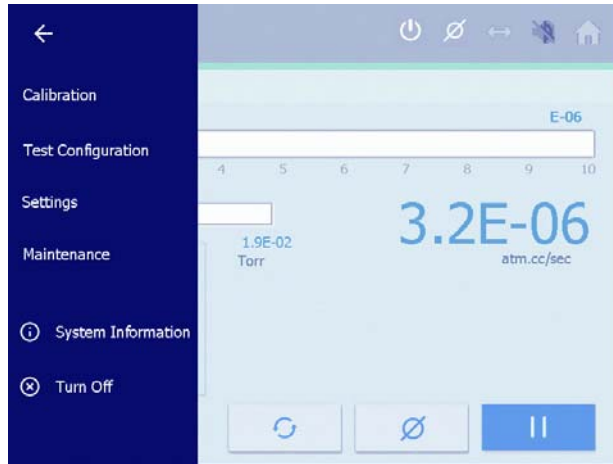

Figure 3-2 Main Menu Select

Power Off

Performs a soft shutdown procedure of the leak detector. Applies a turbo braking routine and exits the CPU's operating system safely. Prompts that the leak detector can be powered down (Figure 3-3).

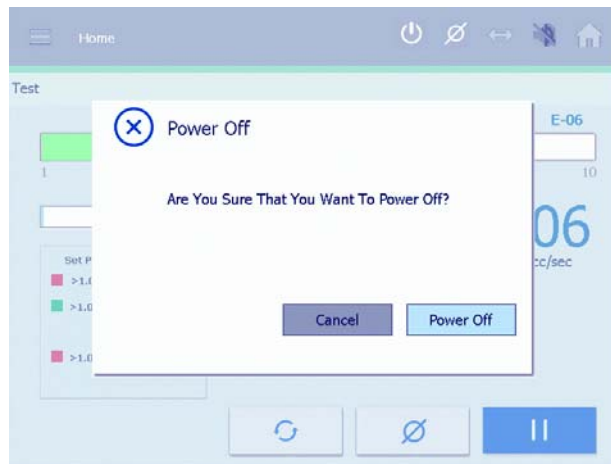

Figure 3-3 Power Off Dialog

Agilent Technologies Helium Leak Detector

Zero Enable

Turns on or off the zeroed out background. This feature excludes the background leak from the leak rate signal.

Helium background represents helium that is in the system but does not come from the part under test. If the background is zeroed out, a more accurate measurement of the leak rate of the part is determined. If Zero Enable is turned ON, the background is excluded; if it is turned OFF, the system displays the full helium signal, including total background.

Table 3-1 Leak Detector Operating States

Display	Description
Calibrating	Indicates that the leak detector is currently performing a calibration routine.
Test	Indicates that the leak detector is in Test mode. When in Test mode, the Test Port valve opens and the leak detector is ready for leak testing. Test leak rate range is 1E-4 to 1E-8 (MDL 5E-9).
Fine Test	Indicates that the leak detector is in Fine Test mode. When in Fine Test mode, the test port valve opens and the leak detector is ready for fine leak testing. Fine Test leak rate range is 9E-7 to 1E-11 (MDL 5E-12).
Hold	Indicates that the leak detector is in Hold mode. When in Hold mode, all but the foreline valves are closed, isolating the test port and any test objects or fixturing from the leak detector vacuum system. Use Hold when you want to keep the test port under vacuum without venting the test volume; this helps the system clean up.
Roughing	Indicates that the leak detector is currently performing a Roughing level evacuation of the test port and any attached test objects or fixturing attached to the test port.
Std Leak	Indicates that the optional internal calibrated leak standard valve is open and that the leak detector is reading the leak value.
Vented	Indicates that the test port is vented to atmosphere. The test port and all objects attached to the test port are isolated from the leak detector internal vacuum system.

Table 3-2 Leak Detector Condition States

Display	Description
Backing	Indicates that the leak detector is momentarily backing the foreline of the high vacuum pump during an extended rough period. Backing occurs if the roughing time is greater than 60 minutes or if the turbo pump is not ready.
Both Filaments/ No Emission	Indicates that no filament emission is detected. This can result from a PCB or cable problem, or burned out filaments.

Agilent Technologies Helium Leak Detector

Table 3-2 Leak Detector Condition States (Continued)

Display	Description
Cal OK	Indicates that the calibration routine was executed successfully.
Calibration Prep	Indicates that the leak detector is preparing for a calibration routine.
Filament 1 No Emission	Indicates that filament 1 of the ion source has burnt out. Filament 2 automatically lights if it is still good, and a flashing C appears in the leak rate exponent, indicating that a calibration routine is required.
Filament 2 No Emission	Indicates that filament 2 of the ion source has burnt out. Filament 1 automatically lights if it is still good, and a flashing C appears in the leak rate exponent, indicating that a calibration routine is required.
Filament Wait	Indicates that the system is lighting the filament.
Flashing C On Exponent Display	Indicates that the leak detector requires calibration.
Gain Too High	Indicates that the gain value required to calibrate the leak detector during the calibration routine is greater than the maximum allowable value. This is generally the result of system sensitivity being too low, due to normal system aging.
Gain Too Low	Indicates that the gain value required to calibrate the leak detector during the calibration routine is less than the minimum allowable value. This is generally the result of a system leak.
High Background	Indicates a high Helium background detected during calibration self-test. This typically, indicates a vacuum system leak.
No Ion Peak	Indicates a tuning/calibration failure due to the system not detecting an ion peak during the auto-tuning routine.
Offset Fault	Indicates an electronics failure identified during calibration self-test.
Offset Wait	Indicates that the system is setting the Offset value.
Reject	Indicates a test object failure during an Auto Sequencer Test cycle. See "Auto Sequencer" on page 84.
Spec-Tube	Flashes red when the spectrometer pressure > 1.0E-4 Torr.
Stabilization Wait	Indicates that the system is waiting for the electronics to stabilize before completing the startup routine; up to two and a half minutes.
Std Leak Prep	Indicates that the optional internal calibrated leak is being roughed before it is introduced directly to the system for calibration verification.
Switching Filaments	Indicates that the system is momentarily in the process of switching from a burnt out filament to the next available filament.

Agilent Technologies Helium Leak Detector

Table 3-2 Leak Detector Condition States (Continued)

Display	Description
System Pressure Wait	Indicates that the system (spectrometer) pressure is too high to light the ion source filament.
System Ready	Indicates that the system is ready for testing. This message appears only during the initial startup and is cleared after the first test cycle.
Zeroing	Indicates that the leak detector is in the process of Zeroing out a background signal. The Zero routine is initiated automatically during the startup and calibration routines, or manually when the operator presses the Zero button on the Home screen.
Zeroing Wait	Indicates that the system is setting the initial zero values during the startup routine.

3.1.1 Graphical Display Screen

The graphical display screen (Figure 3-4) represents the leak rate over time. The graphing line appears in blue and changes to red when a reject set point is triggered.

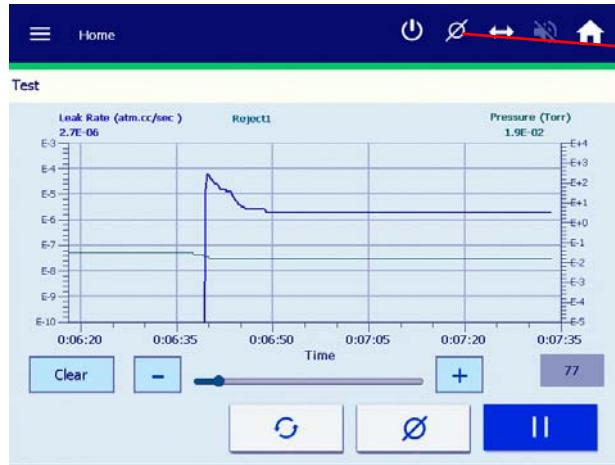

Tapping the graph function symbol toggles between the Home and graphing display.

Figure 3-4 Graphical Display

Audio Speaker Function	The audio signal increases from a low to high frequency as the leak rate increases within each decade. The pitch cycles low to high as it passes through each decade. The audio response corresponds directly to the size of the leak.
Speaker Volume	To turn the sound on/off, press the speaker button. The volume level is restored to the level it was at prior to being turned off.
Timer	Toggles the graphing time between 120 and 720 seconds. The timer automatically defaults to 120 seconds on leak detector start up. Press the toggle button while graphing to clear the current graph. The data rate for the timers are: 120 seconds - two measurements/second 720 seconds - one measurement/three seconds.
Clear	Clears the plotted graph. The graph automatically clears when the leak detector is in roughing mode or at the start of a new test.
Zero	Zeroes out the displayed helium leak. The leak rate must be less than 4.0E-7, while in Test, to allow a cross over to Fine Test. This button causes the leak detector to reset the leak rate display, while the graph tracks the effect of the Zero command.

NOTE



Pressing Zero while introducing helium tracer gas to the test object, or while the helium background is varying significantly, could result in the suppression of a real leak. Only use the Zero button after the helium tracer gas source has been removed.

The Zero capability allows the testing of sensitivity levels that are below the system background. This feature also reduces test cycle times by reducing the amount of time required for background levels to naturally clean up or by allowing testing to begin at relatively high test pressures. It is recommended to zero out only two decades of signal.

3.1.2 Menu Screen

- Press **Menu** on the Home screen. The Menu screen appears (Figure 3-5). Use the arrow to navigate to the previous screen.

The Menu screen consists of buttons to access the lower level screens used for application-specific configuration.

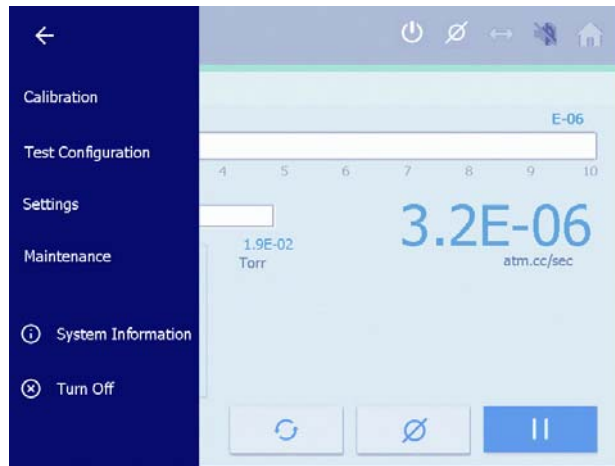

Press a button to access specific configurations.

Figure 3-5 Menu Screen

This page intentionally left blank.

Section 4. Calibration Screen

4.1 Calibration Set-Up

- ❑ Press **Calibration Menu** screen.

The Calibration screen appears (Figure 4-1).

Use this screen to:

- ❑ View the value and expiration date of the Internal Calibrated Leak
- ❑ Enter the External Calibrated leak value
- ❑ Select whether to use an Internal or external calibrated leak
- ❑ Set the calibration mode: Full or Fast Calibration

The calibration routine can only be executed while in Test/FineTest.

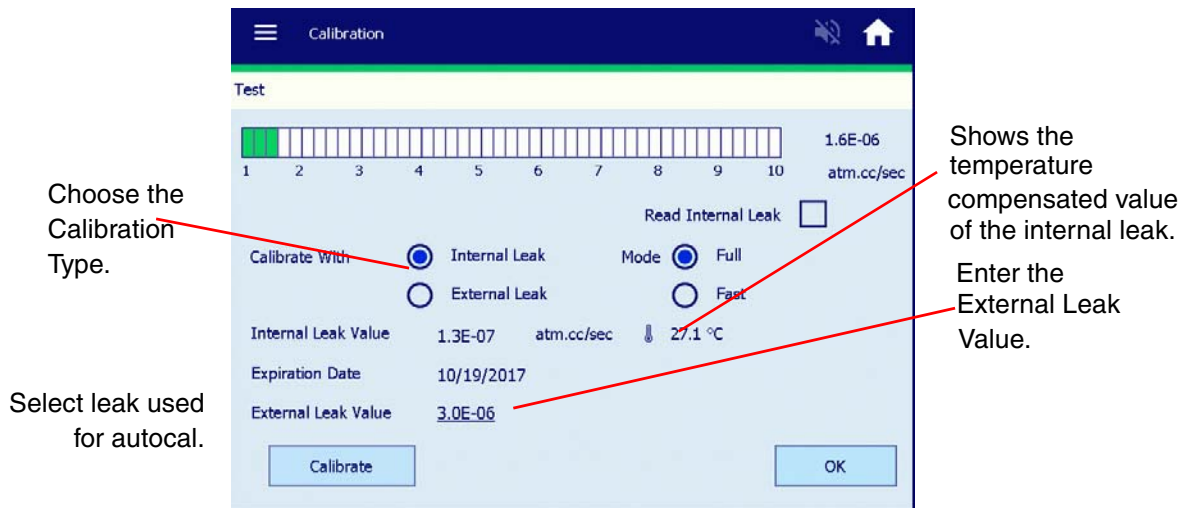

Figure 4-1 Calibration Set-Up



The internal leak is a factory supplied helium leak internal to the leak detector. In order to perform an external calibration, you must supply a separate calibrated leak and mount it on top of the leak detector.

Calibrate

Calibrates the system. *Internal* or *External* appears to indicate which leak the system is using to calibrate.

Automated calibration is performed based on the parameters set on the Calibration screen.

The sequence of events is:

- The leak detector exposes the internal standard leak to the system or verifies that the test port is roughed out and exposes the external leak to the system.
- The ion voltage is scanned to find the peak signal.
- The system notes the leak rate reading, turns the leak off and zeros the system.
- A gain is calculated from the leak rate reading to make the signal match the value of the calibrated leak and returns the system to Test mode.



Figure 4-2 appears within the first twenty minutes of operation if calibrate is selected. This message advises you that a twenty minute warm up is strongly recommended after a cold start up. This twenty minute warm up ensures optimum instrument calibration and peak performance.

- Select **No** - No calibration is performed
- Select **Yes** - Calibration begins.
- No action - Keeps the message displayed and the leak detector automatically calibrates after the 20 minute timer times out.

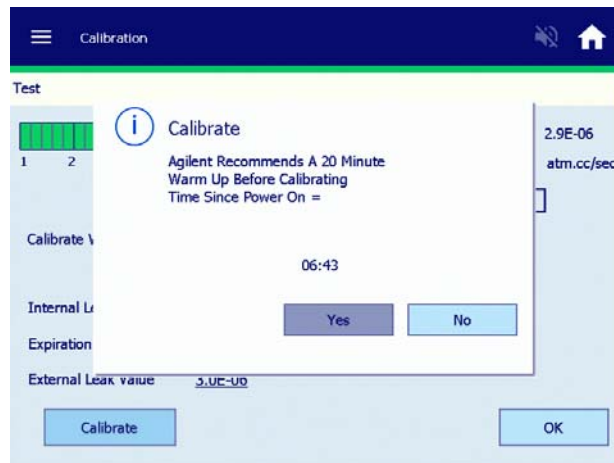

Figure 4-2 20 Minute Warm-up Dialog

Agilent Technologies Helium Leak Detector

Read Internal Leak	<p>Opens the Internal leak valve so the leak can be seen by the system.</p> <p>The Read Internal Leak button is only functional while the leak detector is in Test/Fine test and activates the internal calibrated leak, allowing verification of the system calibration. When the system is in Std Leak mode, Std Leak appears on the Home screen.</p> <p>The Std Leak mode isolates the test port from the system and exposes the leak to the spectrometer. This allows you to compare the <i>displayed</i> leak rate value to the <i>calibrated</i> leak value on the Calibration Menu screen to verify proper system operation.</p> <p>Because the test port is isolated from the fore pump in this mode, a slight increase in test port pressure may be indicated on the test port pressure display.</p>
Full Calibration (Internal Only)	<p>Performs a thorough tuning process and a system gain adjustment (calibration). The full tuning process involves scanning the ion source chamber voltage, and optimizing each value for a maximum helium signal. Once the tuning process is complete, system gain is adjusted to bring the leak detector into calibration. A full calibration takes less than three minutes.</p>
Fast Calibration	<p>Compares the leak rate signal with the calibrated leak value and adjusts the gain to bring the system into calibration. If the gain value is above the upper gain limit for the working range as defined in Table 6-1 on page 107, then the fast calibration process is terminated and a flashing c symbol appears on the Home screen. A fast calibration takes less than 30 seconds.</p>

* If the system cannot read the internal calibrated leak temperature, the system displays the leak value and the temperature shown on the calibrated leak label. If this happens, the calibrated leak symbol on the main screen turns red.

NOTE



External Calibration defaults to Fast Mode only.

Internal Leak Value	<p>The temperature-compensated internal leak value and expiration date appear to the right of the Internal Leak Value text. The actual Internal Leak Value and Expiration Date can be modified in Section 7 “Maintenance Screen” on page 113.</p>
External Leak Value	<p>Displays the value on an operational button.</p>

To configure an external leak:

1. Press **External Leak** (located under Calibrate With).
2. Press the button to the right of the External Leak Value text.

Agilent Technologies Helium Leak Detector

The data entry pad appears.

3. Enter the leak value and press **OK**.

For calibration in the E-10 range, the vacuum system must be sufficiently pumped to reduce helium background below the E-10 range signal level. This is required to achieve an acceptable signal-to-noise level and ensure accurate calibration.

E-10 range calibration is performed using an external calibrated leak. If an external calibration is selected soon after system startup, the system evaluates the helium background and determines if the background signal is sufficiently low to give an accurate calibration. If the:

- ❑ System has pumped out sufficiently, the calibration proceeds.
- ❑ Background is changing, indicating the system is still pumping away background helium, a countdown timer appears (Figure 4-3). The system monitors the helium background and shows the time until the calibration begins. Should you prefer not to wait, a *Cancel* button permits the calibration request to be canceled.

NOTE



The firmware initially starts at a large time interval, but recalculates the required time as the pumping continues. The new time is reflected on the timer.

The new Applications Setup Menu (Test Confutations Menu) helps guides you through the process - Select High Sensitivity.

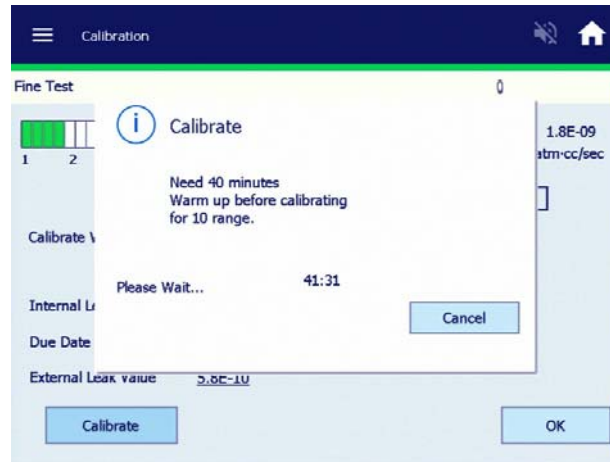

Figure 4-3 Helium Background Timer

Section 5. Test Configuration Screen

5.1 Test Configuration

5.1.1 Test Configuration Menu

The Test Configuration Menu allows you to:

- Program and activate process setpoints (leak rate pressure and audio)
- Enable or disable leak detector advanced features
- Select Leak Detection specific applications with auto parameters setup with step-by-step instructions for enhanced operation.

5.1.1.1 Reject and Audio Set Points

Reject and Audio Set Points make the acceptance and rejection of parts more obvious. By creating a set point, you let the system indicate if the part meets specification or not. For example, you select LEAK RATE #1, set the value to 1.0E-8, set the reject activation to *greater than >* (activate when the leak rate is above that set point), and turn the set point ON. Then when the system is put into TEST, it indicates on the front panel that the part has not meet the set point requirement, until it gets below the set point value and then the set point failure indication disappears.

Multiple set points are used when you want to indicate several levels of acceptance. There are times when you may want to assure the leak detector is working properly by bounding the failure limit. For example, if LEAK RATE #1 were set as per above, then any leak rate below 1.0E-8 would pass the part. Also assume that the leak detector was not seeing helium, it would always pass parts. One way of preventing this from happening is to periodically read the internal calibrated leak. Another way is to place a 5.0E-10 range leak into the test port along with the part and program a second reject set point to fail if the leak detector were to go below that value. In that case, you would program LEAK RATE #2 to 4.7E-10, set the reject activation to *less than <* (activate when the leak rate is below that set point), and turn the set point ON. In this case, when the system is put into TEST, the system indicates a failure if the leak rate goes below 5.0E-10.

- Press **Reject & Audio Set Points** on the Menu screen.

The Reject and Audio Set Points screen appears (Figure 5-1).

Use this screen to:

- Set the parameters to enable or disable.
- Display or change the value of the four reject set points and the audio set point.

Press the desired value to access its keypad

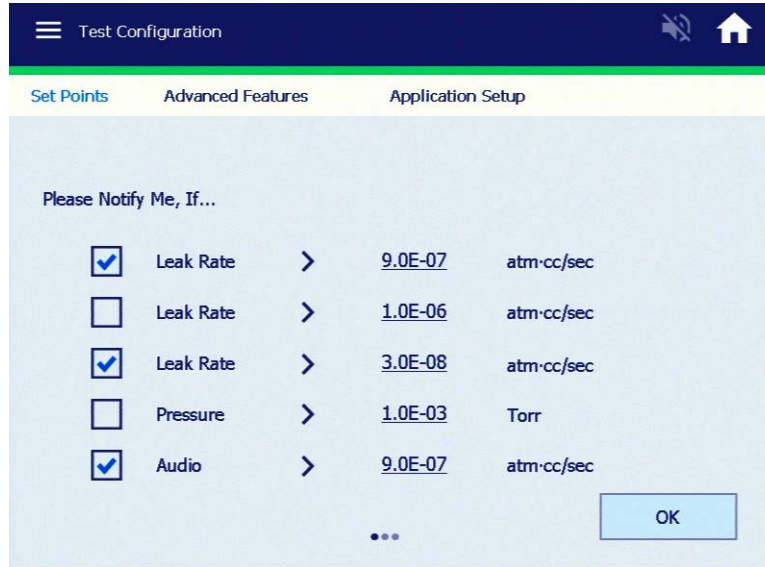

Toggles these options on/off.

Activates the reject set point if below the programmed value

Activates the reject set point if above the programmed value

Figure 5-1 Reject and Audio Setpoints

Reject Set Points

Activate and non-activate set points appear on the Home screen inside the Set Point Status window. The status of the set points are also available through the RS-232 line (see Appendix A “Communications Protocol”).

There are four possible set points. Three set points can be programmed to a leak rate value and one can be programmed to test port pressure.

Set points may be turned ON or OFF (enabled or disabled) for each set point. If a Reject Set Point is ON, then the rear panel output for that set point goes active when its leak rate value is exceeded and an activated red box indication appears on the Home screen.

Each set point is set to activate above or below the programmed value. To activate the reject set point:

- Above the programmed value, select the >.
- Below the programmed value, select the <.

Audio Set Point

Settings:

- On:
The audio tone rate increases proportionally with each decade that the measured leak increases above the set point (leak rate pass/fail specification). The audio volume control is located on the Home screen.



For Plugged Probe Alarm - High Pressure Test (Sniffing Mode) see Section 5.1.3.5 "Sniff Method" on page 79.

- Off:
The audio sounds for all leak rates above zero.

Set points may be turned ON or OFF (enabled or disabled). When the Audio Set Point is OFF, audio sounds for all leak rates above zero. When the audio set point is ON, audio sounds only for leak rates above the audio set point.

To configure reject set points and the audio set point:

1. Press the blue check for the Reject Set Point.
2. Press the value button associated with the set point.
The data entry pad appears.
3. Enter the set point and press **OK**.
4. Press the < or > soft key to select whether the reject setpoint activates above or below the programmed value.
5. Press the blue check for the Audio Set Point.
6. Press the value button associated with the audio set point.
The data entry pad appears.
7. Enter the set point and press **OK**.

5.1.2 Test Configuration Advanced Features

Use this screen to configure the High Pressure Test, Fine Test Only, AZ<0<0, Gross Test, Transfer to Test and Stabilization Wait Timer.

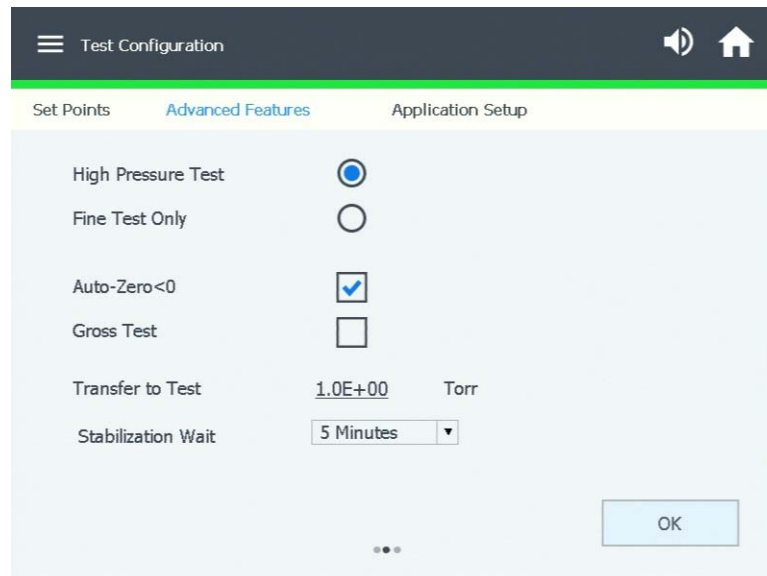

Figure 5-2 Test Configuration Screen

- High Pressure Test Select the **High Pressure Test** mode. When High Pressure Test is selected, Range Stop defaults to 10^{-7} atm cc/sec. High Pressure Test sensitivity mode range is 10^{-4} to 10^{-8} atm cc/sec.
- When the leak detector is in Vent mode:
Turn the High Pressure Test feature on to start the test cycle. This automatically locks the leak detector into Contra-Flow™ Leak mode, and auto-ranges through all decades down to the most sensitive Contra-Flow range.
 - When the leak detector is in Test mode:
Turn the High Pressure Test feature on to perform the same function, with the exception of performing the test cycle start sequence.
- Fine Test Only Select the **Fine Test Only** switch to enable the feature. When selected and Test is initiated on the Home Screen the leak detector transfers from Test to Fine Test and remains in Fine Test regardless of leak rate. If the test port pressure is greater than $1.4E-1$ Torr the leak detector transfers back to the Roughing Mode.

Agilent Technologies Helium Leak Detector

Auto-Zero<0 Active Adjusts the zero reference point automatically and continually to the correct zero value when the helium background level drops below the previously set zero reference point. This feature ensures that the leak detector maintains a correct balance value after a previously zeroed background signal naturally cleans up (background helium is pumped away).

When the Auto-Zero < 0 feature is in the process of re-adjusting the zero reference point, the arrows located on the left end of the bar graph illuminate. These arrows indicate that the measured helium leak rate is currently less than the minimum displayable value. The arrows may flash briefly as the system recovers from a leak indication and the displayable leak rate approaches zero. If the Auto-Zero < 0 is turned on, the arrows may also flash briefly as the system resets the zero point to a lower value. The leak detector does not display a leak rate while the arrows are on. If the arrows remain on for more than a few seconds, press Zero to set operating parameters to the correct zero value. This situation can occur if the leak detector had not been fully warmed up when a previous calibration was initiated.

Auto-Zero < 0 Inactive When Auto-Zero < 0 is inactive, the leak detector does not automatically adjust the zero reference point when the helium background level drops below the previously set zero reference point. In this condition, a leak less than the previously set zero value is not indicated by the system. Instead, the arrows remain lit, indicating that the background level is below the previously set zero reference point. Press Zero on the front panel to readjust the zero reference point manually. This clears the lights.



For High Pressure Test/Sniffing mode, de-activation (Inactive AZ<0) is highly recommended. Manual Zeroing produces a more desirable performance, thus eliminating false leaks due to fluctuations in test port pressure while in test.

Gross Test Allows the operator to locate leaks while the system is in roughing mode. The test indicates the presence of a leak at high pressures only and does not display a leak rate value.

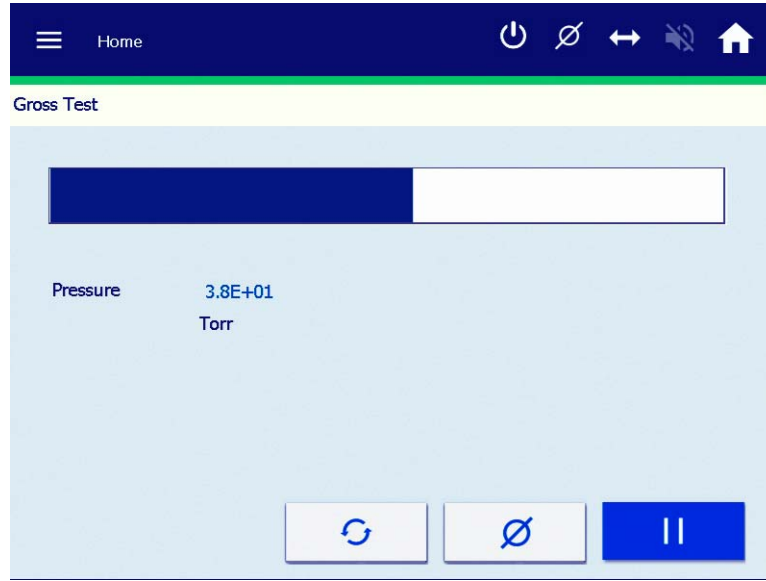

Figure 5-3 Gross Test Screen

- Gross Test is activated in the Test Configurations > Advanced Features menu.
- Once activated, the GROSS TEST button appears on the Home screen. Press *GROSS TEST* to enter the screen.
- There is an audio tone for Gross Leak testing, which increases as the leak increases.
- Gross Test only works when the test port pressure is between 10 and 150 Torr and remains constant ($\pm 2\%$ between previous and current pressure readings).
- The Gross Leak test stops if the system goes into Backing, Test or Fine TEST mode.
- Activating the Auto Sequencer button terminates the Gross Leak test.
- The HOLD button is inactive while in Gross Leak test mode, as the system is in roughing mode.

5.1.2.2 Transfer to Test

The value input and hidden keypad is to the right of the Transfer to Test feature. Use it to set the pressure at which the system goes into Test.

The Transfer to Test setting can be adjusted to lower values for specific applications. The limit on the maximum test pressure prevents the operator from inadvertently setting the leak detector to transfer into test at too high a pressure, which would result in excessive spectrometer contamination or ion source filament failure.

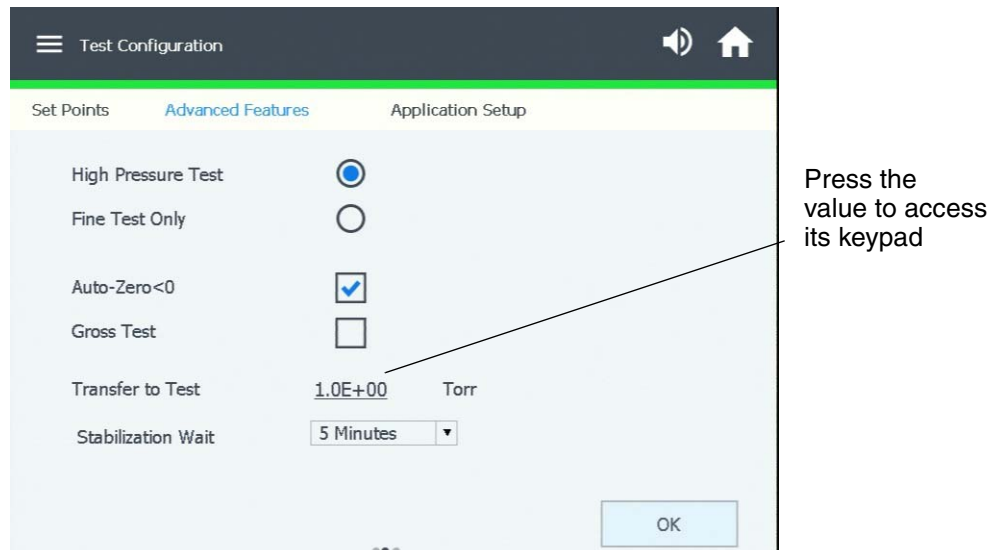

Figure 5-4 Transfer to Test

Maximum Test Pressure

Determines the test pressure cross over point at which the system transfers from Roughing into Test and then into the Contra-Flow Test mode. In the Contra-Flow Test mode, the gas sample is pumped through the leak detector and swept across the high vacuum pump foreline. The Contra-Flow mode allows for higher sensitivity testing at exceptionally high test pressures.

The maximum test port pressure is 10 Torr.



NOTE

The transfer pressure from the Test mode to the Fine Test mode is set at 100 milliTorr (1.0E-1 Torr). You may wish to lower that value under certain circumstances. The mid-stage transfer pressure limit is adjustable from 1 to 100 milliTorr via an RS-232 command (see ML-XFER and INIT-ML-XFER in Section A “Communications Protocol” on page 139). The pressure limit is not adjustable using the display.

5.1.2.2.1 Stabilization Wait Timer

Figure 5-4 shows the Transfer Points screen.

Stabilization Wait This appears on the Home screen after a successful startup. This timer is necessary for the spectrometer stabilization and degassing. The factory default is 5 minutes. It is highly recommended for those customers who infrequently use the leak detector or expose the leak detector to aggressive applications to select the **9** or **15** minute selection. For example: Select **9** minutes for a leak detector that is used once a week or select fifteen minutes for a leak detector that is used once a month or less.

5.1.2.3 High Pressure Test Set-Up Procedure

The High Pressure Test mode locks the system into contraflow, offering maximum protection to the spectrometer. This is useful in sniffing applications or when evacuating parts that can contaminate the system.

To configure the High Pressure Test (optional):

1. If sniffing, vent the leak detector and attach a Agilent Power Probe (Part Number K9565306) to the test port.
2. Monitor the test port pressure reading on the display and adjust the power probe flow valve for a test port pressure of 0.5 to 1 Torr (2 Torr maximum). This pressure setting allows for very rapid system response.

High Pressure Test mode sensitivity is 10^{-4} to 10^{-8} atm cc/sec at test port pressures between 1 and 2 Torr using the power probe.

When High Pressure Test is activated, range stop defaults to 10^{-7} atm cc/sec.

High Pressure Test mode sensitivity is 10^{-4} to 10^{-8} atm cc/sec at test port pressures between 500mTorr and 2 Torr using the power probe. When High Pressure Test is activated, range stop defaults to 10^{-7} atm cc/sec, but selecting between 10^{-4} to 10^{-8} atm cc/sec is permitted.

1. Select **High Pressure Test** to enable the High Pressure Test mode. When High Pressure Test is selected, Range Stop defaults to 10^{-7} atm cc/sec. High Pressure Test sensitivity mode range is 10^{-4} to 10^{-8} atm cc/sec.
2. Wait for the leak detector to enter Vent mode.
3. Turn the High Pressure Test feature on to start the test cycle. This automatically locks the leak detector into Contra-Flow™ Leak mode, and auto-ranges through all decades down to the most sensitive Contra-Flow range.
4. Wait for the leak detector to be in Test mode.
5. Turn the High Pressure Test feature on to perform the same function, with the exception of performing the test cycle start sequence.

5.1.2.4 Home Screen - Activate Gross Test

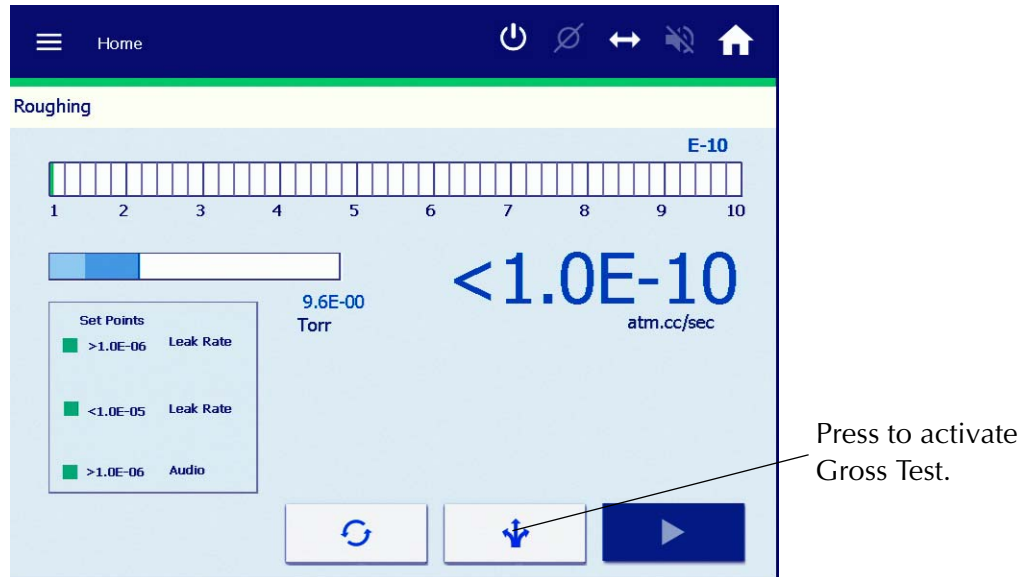

Figure 5-5 Home Screen - Activate Gross Test

Gross Test

Allows the operator to locate leaks while the system is in roughing mode. The test indicates the presence of a leak at high pressures only and does not display a leak rate value.

1. Activate Gross Test.

The GROSS TEST button appears on the Home screen when the test port pressure is between 10 and 150 Torr.

2. Press GROSS TEST to enter the screen.

- There is an audio tone for Gross Leak testing, which increases as the leak increases.
- Gross Test only works when the test port pressure is between 10 and 150 Torr and remains constant ($\pm 2\%$ between previous and current pressure readings).
- The Gross Leak test stops if the system goes into Backing, Test or Fine TEST mode.
- Activating the Auto Sequencer button terminates the Gross Leak test.
- The HOLD button is inactive while in Gross Leak test mode, as the system is in roughing mode.

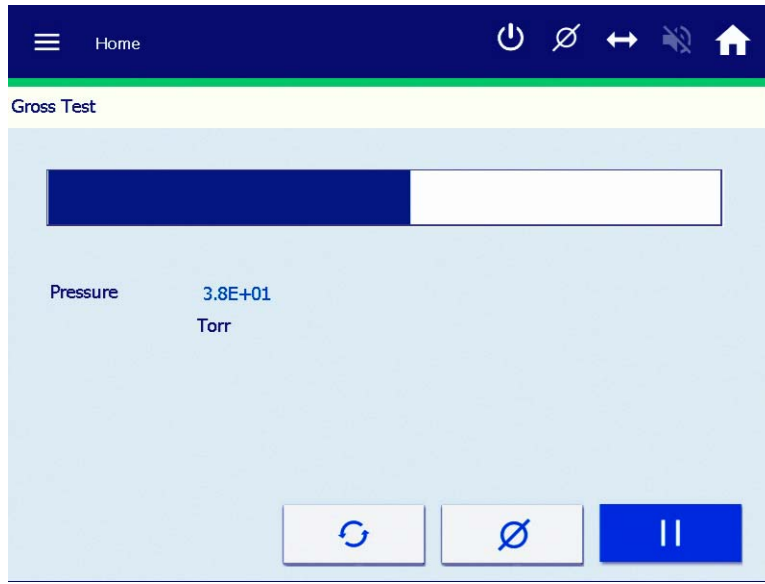

Figure 5-6 Home Screen - Gross Test Active

5.1.3 Application Setup

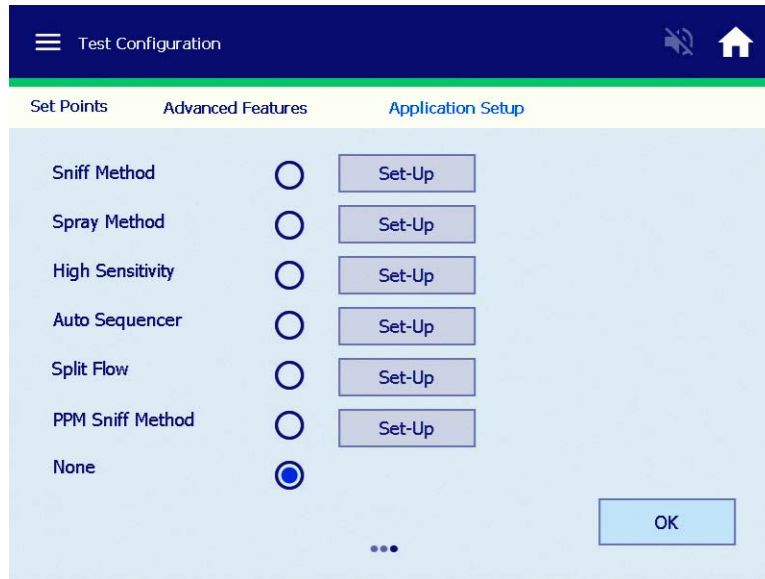

Figure 5-7 Application Setup

5.1.3.5 Sniff Method

Utilizing the Agilent Power Probe connected to the test port of the Helium Leak Detector, the sniff method pinpoints the location and magnitude of leaks from volumes that have been filled with helium. Settings available in this mode include:

- ❑ Establishing the minimum displayed range - avoids the distraction of inconsequential leaks.
- ❑ Entering set point values for audible and visual alarms.
- ❑ Adjusting the sampling pressure for best response and clean up and establishing an alarm should the sniffer probe become plugged.

To access:

1. Select **Test Configurations > Applications Setup**.
2. Select **Sniff Method** and press **Set-Up** and Figure 5-8 appears.

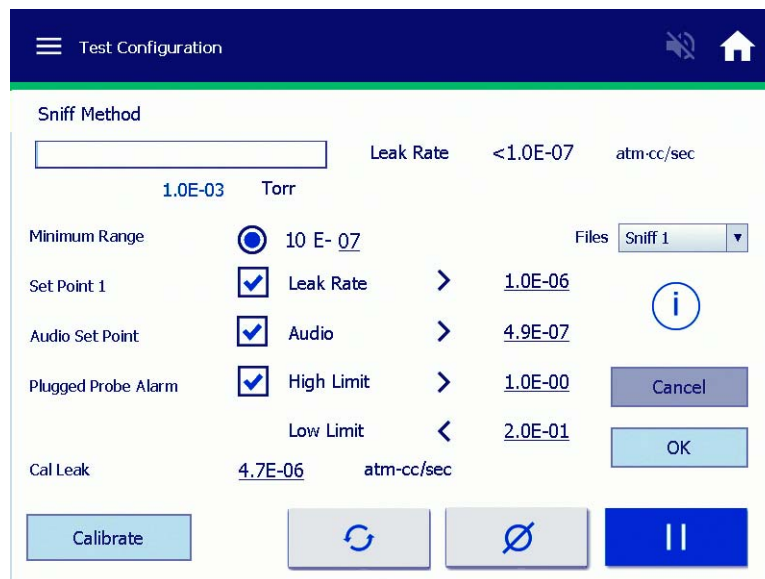

Figure 5-8 Sniff Method

At this point:

- ❑ The leak detector locks into High Pressure Test(*Test only*)
- ❑ Auto Zero < 0 is disabled
- ❑ Minimum Range defaults to 10^{-7} - This value can be adjusted from 10^{-8} to 10^{-4}

Buttons and Fields

Set Point 1

Desired *Alarmed Leak Rate* value (> <) - This value can be adjusted from 10^{-8} to 10^{-4} . *Set Point* values in Sniffing applications are usually programmed for greater than the acceptable leak rate limits.

Agilent Technologies Helium Leak Detector

Audio Set Point: Desired *Audio Alarmed Leak Rate Value* (> <) - This value can be adjusted from 10^{-8} to 10^{-4} . The *Audio Set Point* triggers with its' own distinct tone if different from *Set Point 1*.



The Audio Setpoint is very useful in the Sniffing Application. The programmed Audio Set Point value can be programmed 50% < Set Point 1, which alarms the operator that they are approaching a leak (leak location).

Plugged Probe Alarm A distinct high frequency tone different from the *Audio & Set Point 1*. This alarm is useful in alerting the operator that the desired *Power Probe/Sniffing Probe* adjustment (pressure) has changed. A *High Limit* can be selected in alerting that too much flow (high test port pressure) is present. A *Low Limit* trigger is typically the norm indicating that the *Power Probe/Sniffing* is blocked or the tubing is kinked or pinched off.

Files The operator can store up to three setup configurations:

- *Sniff 1-3*



The information icon provides the necessary directions for a successful external calibration.

Calibrate External calibration/Sensitivity check: Follow the step by step process.

5.1.3.6 Spray Method

The spray method is for leak testing vacuum systems of all sizes. When properly connected to the vacuum system under test, the Helium Leak Detector will locate and indicate the relative size of leaks. Settings available in this mode include:

- Entering set point values for audible and visual alarms.
- Connecting the wireless remote - allows testing of large systems by one operator.

To access:

1. Select **Test Configurations > Applications Setup**.
2. Select **Spray Method** and press **Set-Up** and Figure 5-9 appears.

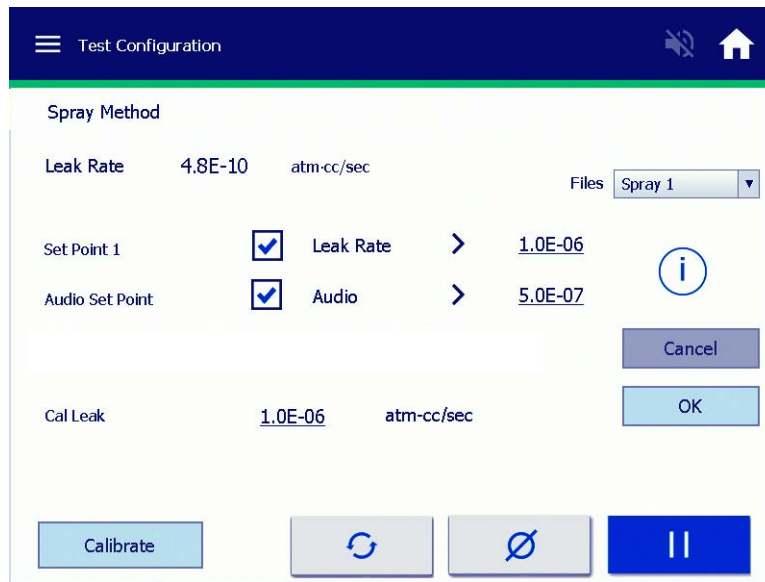

Figure 5-9 Spray Method

At this point *Auto Zero < 0* is enabled.

Buttons and Fields

Set Point 1 Desired *Alarmed Leak Rate* value (> <) - This value can be adjusted from 10^{-10} to 10^{-4} . *Set Point* values in *Spray* applications are usually programmed for greater than the acceptable leak rate limits.

Audio Set Point Desired *Audio Alarmed Leak Rate* value (> <) - This value can be adjusted from 10^{-8} to 10^{-4} . The Audio Set Point triggers with its' own distinct tone if different from *Set Point 1*.

Remote Control The wireless handheld remote can be activated and configured (channel selection) within this application.

NOTE



The Wireless Remote is a factory and field installed customer option.

Files

The operator can store up to three setup configurations:

- *Spray 1-3*



The information icon provides the necessary directions for a successful external calibration.

Calibrate

External calibration/Sensitivity check: Follow the step by step process.

NOTE



The external calibration routine for the Spray Method is typically performed on large chamber applications for proper characterization of the leak rate measurement.

5.1.3.7 High Sensitivity

Often, calibration to a known, external helium leak standard is required for internal quality requirements or additional accuracy. *High Sensitivity Test* guides you through this procedure. Settings available and features in this mode include:

- ❑ Establishing the minimum displayed range - avoids the distraction of inconsequential leaks.
- ❑ Step-by-step guidance on the external calibration procedure.
- ❑ Employs additional software routines to improve stability at low leak rates.

To access:

1. Select **Test Configurations > Applications Setup**.
2. Select **High Sensitivity** and press **Set-Up** and Figure 5-10 appears.

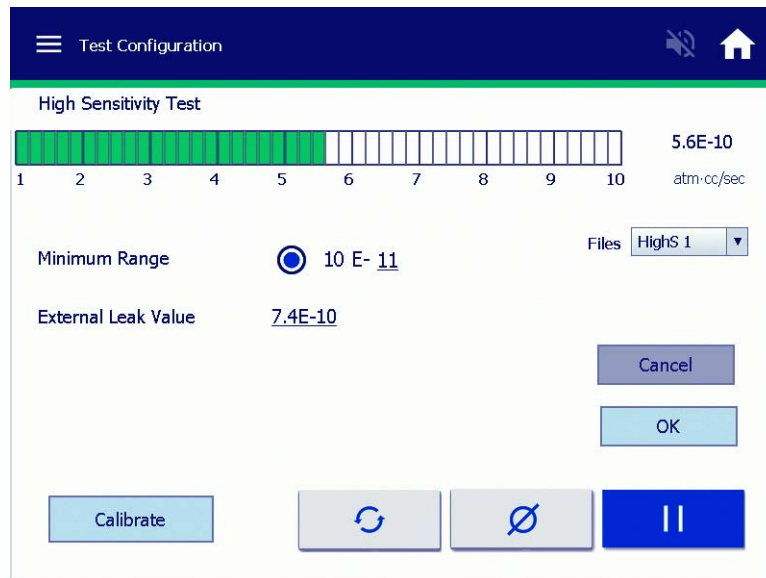

Figure 5-10 High Sensitivity

To perform a calibration process (internal and external) for a precision 10^{-10} leak rate accuracy and stability:



*Minimum Range can be programmed - Default 10^{-10} .
Auto Zero < 0 is disabled.*

Calibrate

External calibration/Sensitivity check: Follow the step by step process.

Files

The operator can store up to three setup configurations:

- ❑ *HighS 1-3*

5.1.3.8 Auto Sequencer

The Agilent *Auto Sequencer* facilitates programming a repetitive test cycle for leak testing parts that have been sealed with helium inside. This can improve productivity and reduce testing errors. Settings available in this mode include:

- ❑ Program timers for the roughing and test modes.
- ❑ Entering set point values for audible and visual alarms.
- ❑ Establishing a lower level verification leak to improve reliability of the test.
- ❑ Setting a pressure set point that saves time by rejecting a part if the pump down characteristics fall outside of the norm.

The auto sequencer is used to automatically perform testing on a part, to maximize testing throughput and to reduce the chances of accidentally accepting a bad part. The auto sequencer is used in conjunction with the reject and audio set point settings, which provide the criteria for pass or fail conditions. Within the auto sequencer feature, there are two variables that must be set, rough time and test time. The ROUGH TIME setting indicates to the system the maximum time it is allowed to be in roughing before the test fails. Ideally, the system goes into the roughing phase and then proceeds to TEST. The TEST TIME setting tells the system when to perform the test against the set point values. For example, you may set 20 seconds for the TEST TIME. At the end of 20 seconds, the system determines if the part has passed or not and then makes an indication by either going to VENT (Pass) or going to HOLD (Fail) and displaying the reject set point failure on the front panel.

- ❑ Press **Auto Sequencer Set-Up** on the Menu screen.

The Auto Sequencer Set-Up screen appears (Figure 5-11). The leak detector can be configured to automatically run through a complete test cycle (Start/Rough/Test/Vent).

During the test cycle, the system ensures that during the Rough Time the user-entered pressure transfer set points are met.

A *Pass* condition is indicated by the system reverting to the Vent mode upon completion of the test cycle. A *Fail* condition is indicated by the system reverting to the Hold mode, and all operating buttons being disabled except Vent. A failed condition also results in a red activated set point box in the Set Point window appearing on the Home screen, along with a reject set point activation upon completion of the test cycle. The status of the reject set points are available through the RS-232 line (see Appendix A “Communications Protocol”).

On completion of an automated test cycle, the leak detector captures the leak rate signal measured just prior to the end of the automated test cycle. This leak rate appears on the Home screen until the next test cycle is initiated.

Rough Time	<p>Determines the amount of time that the leak detector is allowed to evacuate the test object to the Maximum Test Pressure (see Section 5.1.2.2 on page 75). In Auto Sequencer mode, the leak detector transfers into test as soon as the specified transfer pressure is met. If the specified test transfer pressure is not achieved within the pre-selected rough time, the system aborts the cycle and goes into Hold mode.</p> <p>The Rough Time value is determined empirically and reflects the typical time required to rough the test object to the specified test pressure. Failure to achieve the test pressure within the pre-selected rough time indicates a gross leak in the test object or test fixturing, or that the time allowed was insufficient.</p> <p>The rough timer records the amount of time the system spent in the roughing phase prior to it entering the TEST mode. The rough timer is intended to help you set up a <i>rough time</i> value since it can be difficult to predict accurately how long the system is in the roughing phase when you cycle. Put the system into TEST mode, the rough timer records and displays the rough time so that you can enter a rough time value close to what was recorded. For example, if the rough timer records a value of 12 seconds, you can then enter a value in the <i>rough time</i> that is slightly longer than what was recorded, 15 seconds for example. The rough timer only records a time when the auto sequencer is ON.</p>
Test Time	<p>Determines the amount of time that the leak detector remains in test before it compares the measured leak rate with the selected reject set point. Allow sufficient time for the leak rate reading to stabilize before the system makes a pass/fail decision. This is a function of the part configuration and the leak rate specification. In Auto Sequencer mode, the leak detector remains in test for the entire duration of the preselected test time.</p>

To configure the auto sequencer mode:

1. Press the blue check to turn on the Auto Sequencer.
The pass/fail criterion is based on the reject set points that are enabled.
2. Press the value button associated with the Rough time.
The data entry pad appears.
3. Enter the time and press **OK**.
4. Press the value button associated with the Test time.
The data entry pad appears.
5. Enter the time and press **OK**.

Agilent Technologies Helium Leak Detector

- Press **TEST** and let the system record the actual time spent in roughing. After the test is complete, use the recorded rough timer value to set an appropriate rough time.

To access:

1. Select **Test Configurations > Applications Setup**.
2. Select **Auto Sequencer** and press **Set-Up** and Figure 5-11 appears.

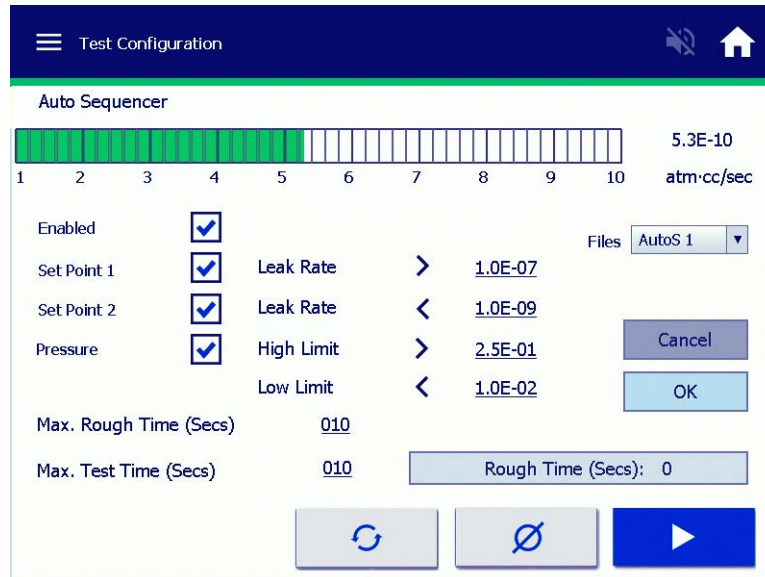

Figure 5-11 Auto Sequencer

The auto sequencer is used to automatically perform testing on a part, to maximize testing throughput and to reduce the chances of accidentally accepting a bad part.

The auto sequencer is used in conjunction with *Set Points 1 & 2* and *Pressure Set Point* settings, which provide the criteria for pass or fail conditions.

Within the auto sequencer feature, there are two variables that must be set, *Rough Time* and *Test Time*.

Rough Time

This setting indicates to the system the maximum time for the leak detector to be in *Roughing* mode. If the *Rough Time* is exceeded the test aborts and the system goes into *Hold*. This is a failed condition. Ideally, the system goes into the *Roughing* phase and then proceeds to *TEST* (setup below).



The Rough Time value is determined empirically and reflects the typical time required to rough the test object to the specified test pressure. Failure to achieve the test pressure within the pre-selected rough time indicates a gross leak in the test object or test fixturing, or that the time allowed was insufficient.

Test Time

This setting tells the system when to perform the test against the set point values. For example, you may set 20 seconds for the *Test Time*. At the end of 20 seconds, the system determines if the part has passed or not and then makes an indication by either going to *VENT* (Pass) or going to *HOLD* (Fail) and displaying the reject set point failure on the *Home* screen. The final leak rate value appears on the *Home* screen regardless of a pass or failed criteria. The next test cycle (pressing **Test**) clears the leak rate value (setup below).



The Test, Vent and Zero functions are available in this application setup. The Test and Vent buttons aid in setting up the Rough and Test Timers. The Zero function is extremely helpful in zeroing out unwanted background associated with the test fixture. The zeroing set up helps in reducing the test time.

5.1.3.8.2 Auto Sequencer Set-Up

Attach the test fixture with the part to be tested (known good test object) on to the leak detector test port.

5.1.3.8.2.1 Rough Time Setup

Determines the amount of allowable time for the leak detector to evacuate the test object to the *Transfer Point - Transfer Pressure*.

To test:

1. Select **Test Configurations > Advanced Features > Setup**.

If the transfer pressure is not achieved within the pre-selected rough time, the system aborts the cycle and goes into *Hold* mode.



Factory Default - Transfer Point (Transfer to Test Pressure) is 1 Torr

Do not activate or program any *Set Points*.

2. Program the *Rough Timer* for some unrealistic amount of time, like 200 secs.
3. Program *Test Time* for 30 secs and press **Test**.
Allow the test to complete (system vents).
4. *Program the Rough Time as displayed in the Rough Time window.*

5.1.3.8.2.2 Test Time Setup

1. Program the *Test Time* for some value that allows for correct characterization of the necessary test time to reach at least one decade less than that of *Setpoint 1* (reject level).
2. Input the desired *Test Time*.

5.1.3.8.2.3 Set Point 1 Setup

1. Input the *Leak Rate* value that is a failed/reject condition.
2. Typically, a greater than condition is programmed.

5.1.3.8.2.4 Set Point 2 Setup

You can choose between the two setpoints.

1. Input the *Leak Rate* value that is a failed/reject condition.
2. Typically, a greater than condition is programmed.



A Typical Auto Sequencer application uses either Set Point 1 or Setpoint 2 for the desired leak rate reject set point.

5.1.3.8.2.5 Using Set Point 1 and 2 together (Optional)

Some applications utilize a reference leak during the test cycle to validate that the leak detector is still calibrated and sensitive to helium.

- Set Point 1* is set up for the leak rate reject level (>).
- Set Point 2* is set for the reference leak (<).



If the leak rate falls below the reference leak value (Set Point 2) at the end of the test cycle, the leak detector reports Rejected/Hold. This type of a reject is a system level failure. This could be related to a fixturing issue, operator error or system performance.

5.1.3.8.2.6 Pressure Set point (High & Low Limit) - Optional

- High Limit* - Input the high-pressure limit that must not be exceeded during the test.
- Low Limit* - Input the low-pressure limit that must be maintained throughout the test.
- Files: The operator can store up to three setup configurations:
 - AutoS 1-3

5.1.3.9 Split Flow

Activating the split flow option properly characterizes the system to an external calibrated leak, which is influenced by additional vacuum pumping sources. These separate vacuum pumping sources reduce the amount of helium measured by the leak detector.

The split flow option is very useful for external calibrations where external gain factors exceed the limit of 50 due to a high helium background (Range Stop E-8). The split flow factor is also useful for calibrating to a standard leak while in the sniffing mode (High Pressure Test).

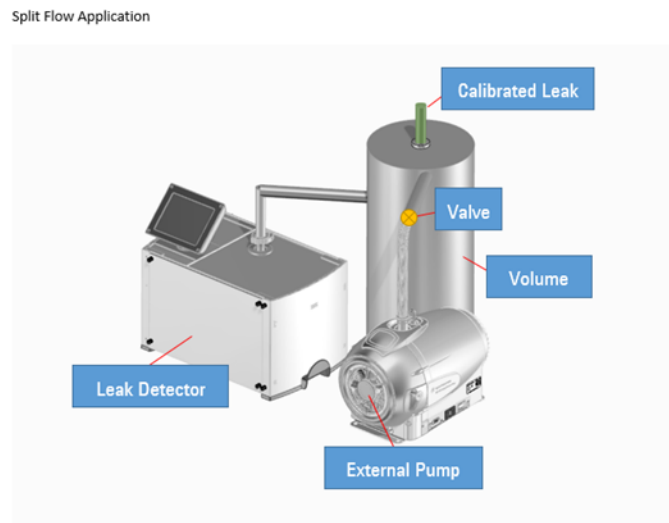

Figure 5-12 Split Flow Application

Leak detectors are frequently connected to vacuum systems in parallel with other vacuum pumps. This can cause errors in readings when testing to a specific value is important. Split Flow properly compensates for flow differences caused by additional pumps. Settings available in this mode include:

- Setting the value of the installed reference leak.
- Step-by-step guidance in setting the split flow value.
- Entering set point values for audible and visual alarms.
- Enabling an *Extended Split Flow* routine when testing with low concentrations of helium and/or to quantify large leak values.

Ground rules and assumptions:

- The software limits split flow to no more than 1000 times (3 decades). If the split flow is turned ON and the leak rate entered is more than 1000 times higher than the system leak rate, the system will not allow the split flow to turn ON and <> appears.

Agilent Technologies Helium Leak Detector

- ❑ At the main screen, the system blinks the split flow symbol  when split flow is ON.
- ❑ When split flow is turned ON, it displays the corrected leak rate but it knows the real leak rate value.
- ❑ When ZERO is pressed with when split flow ON, the system zeros out background up to a limit equal to the maximum split flow value.

To activate split flow:

1. Place the system into TEST mode and let the leak rate stabilize. Calibrate the system.
2. Press the Split Flow blue check button. The leak detector prompts you to enter the leak rate for the customer's calibrated standard leak (what the leak rate should be).

The leak detector displays the corrected leak rate, essentially calculating a split flow gain value. The leak detector automatically calculates the split flow factor, turns on and calculates the range stop, based on the split flow factor.

When Split Flow is turned OFF, the system reverts back to the uncorrected leak rate. This process must be repeated when reactivating split flow.

To setup:

1. Connect the leak detector and secondary rough pump to the test chamber as seen in Figure 5-12.
2. Install the External Calibrated Leak on the test chamber.
3. Press **Test** on the leak detector.
4. Open valve on secondary rough pump to evacuate test chamber.
5. Select **Test Configurations > Applications Setup** and Figure 5-13 appears.
6. Select **Split Flow** and press **Setup** and Figure 5-13 appears.



The information icon provides the necessary directions for a successful external calibration.

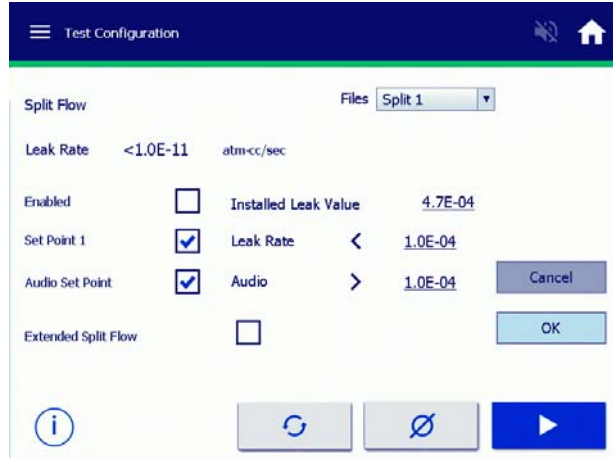

Figure 5-13 Split Flow Setup

7. Enter the value of the installed external calibrated leak.
8. Optional - Enter a *Set Point 1* leak rate value.
9. Optional - Enter an *Audio Set Point* value.
10. Press **Continue**.

"Files - operator can store up to three setup configurations:

oSplit 1-3

Extended Split Flow is used in applications where the *External Standard Leak* values are greater than the upper leak rate limit of the leak detector ($>9.9E-4$ std. cc/sec He) but can be measured due to a large split flow condition.

Example: $5E-1$ std. cc/sec He standard leak measures $5E-5$ std. cc/sec He on the Agilent Helium Leak detector. The out of range *Installed Leak Value* can be entered and *Extended Split Flow* can be activated.



The software limits split flow to no more than 1000 times (3 decades). If the split flow is turned ON and the leak rate entered is more than 1000 times higher than the system leak rate, the system will not allow the split flow to turn ON and <> appears.

At the main screen, the system blinks the split flow symbol when split flow is ON .

When split flow is turned ON, it displays the corrected leak rate but it knows the real leak rate value.

When ZERO is pressed with when split flow ON, the system zeroes out background up to a limit equal to the maximum split flow value.

5.1.3.10 PPM (parts per million) Sniff Method

Certain test protocols specify parts per million (PPM) units for measuring leak rates. This test method is only to be used with a suitable sniffer probe, it is not intended for vacuum leak testing. Settings available and features in this mode include:

- Setting the value of helium concentration to be used for calibration.
- Step-by-step guidance to calibrate to a known concentration.
- Using a mass flow meter (optional) for accurate measurement regardless of pressure.
- Entering set point values for audible and visual alarms.
- Establishing an alarm should the sniffer probe become plugged.

NOTE *Calibrate the leak detector prior to the PPM Sniff Application.*



To run this:

1. Select **Test Configurations > Applications Setup**.
2. Select **PPM Sniff Method**, press **Set-Up** and Figure 5-14 appears.

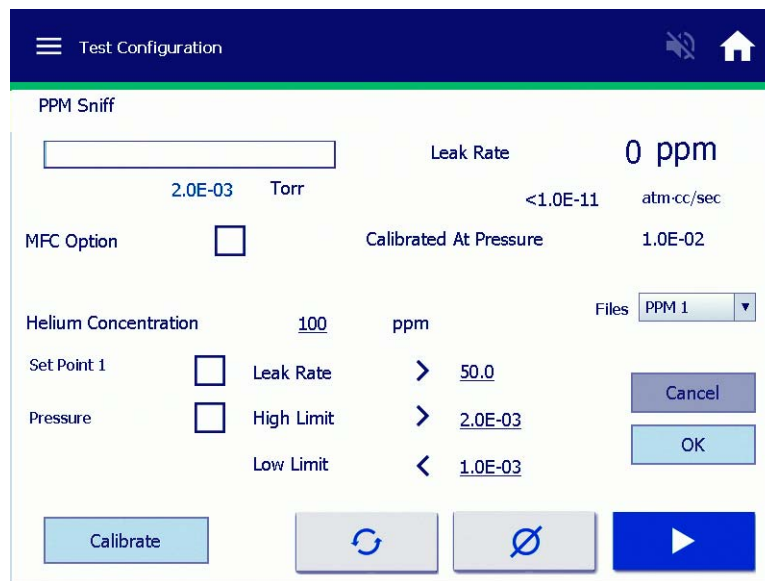

Figure 5-14 PPM Sniff Method

3. Ensure that the leak detector must be in *Test* and setup for a sniffing application as shown in Figure 5-15. The test port pressure appears in the top left hand corner of the setup screen (Figure 5-14).

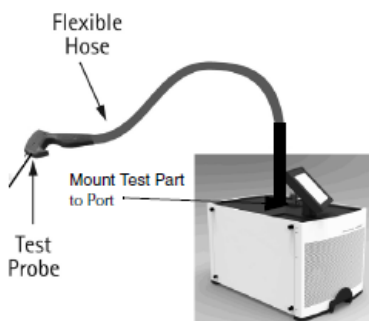

Figure 5-15 Sniffing Setup

4. If the leak detector is vented - Press the **Test** button in the bottom right hand corner. Adjust the metering valve on the Sniffing Probe until a desired value between 5.0E-1 and 1 Torr is obtained.

In this Setup Screen the leak detector can be configured to measure PPM concentrations of Helium from the following three methods:

- ❑ Calibrating to a known Helium PPM concentration (“Calibrating to a Known Helium PPM Concentration” on page 94).
- ❑ Monitoring the actual flow rate in real time from a recommended Mass Flow Meter manufacturer (Alicat Scientific) via the RS232 port to obtain the calculated Helium PPM concentration at the adjusted test port pressure (“Measuring PPM of Helium with an Alicat Scientific Brand Mass Flow Meter” on page 94).
- ❑ Inputting the flow rate (sccm) from any Mass Flow Meter or Mass Flow Controller via the displayed flow rate reading/value at the adjusted test port pressure to obtain the calculated Helium PPM concentration (“Measuring PPM of Helium with a non-Alicat Scientific brand Mass Flow Meter” on page 98).

NOTE



Parts per million (PPM) of helium may be measured using a helium leak detector that is either used in conjunction with a mass flow meter, or is calibrated using a known concentration (PPM) of helium. PPM of helium is described as the flow rate of helium divided by the flow rate of total gas, multiplied by 100. If there are 5 moles of helium, and 999,995 moles of other gas, then the concentration is 5 PPM helium. This is a typical concentration of helium at sea level on earth.



The information icon provides the necessary directions for a successful external calibration.

5.1.3.10.3 Calibrating to a Known Helium PPM Concentration

- Cheapest method
- Fastest response time
- Requires calibration using a known Helium PPM gas mixture



This requires calibrating using a known PPM mixture, such as a 50 PPM helium mixture. To sample the gas concentration, the operator may use either the standard power probe sniffing gun (Agilent part number K9565306), or any small ID SST or copper tubing attached to Swagelok fine metering valve (Swagelok part number: SS-SS4).

To do this:

1. Select **Test Configurations > Applications Setup**.
2. Select **PPM Sniff Method > Application Setup**.
3. Ensure the system is in **Test** and the test port pressure adjusted between 5E-1 Torr 1 Torr.
4. Enter the Helium concentration in PPM in the associated field.
5. Press the **Calibrate** button (Figure 5-14 on page 92) and follow the step-by-step instructions. The leak detector is now ready to measure the concentration of Helium in PPM.

5.1.3.10.4 Measuring PPM of Helium with an Alicat Scientific Brand Mass Flow Meter

- Scientific confidence added through accurate computation of both helium leak rate, and gas flow rate.
- Slower response time than without using mass flow meter at all.
- Requires Alicat Scientific 1 SLM Whisper series mass flow meter.
 - Alicat Scientific part number MW-1SLPM-D-DB15/5M, GAS: Air. Comes with DC power supply & RS232 cable.
- Requires a mid E-5 std. cc/sec He calibrated standard leak.

Application Setup

1. Assemble a fine metering valve, as described in Figure 5-17 and follow the assembly notes.
2. Connect the fine metering valve in series with the leak detector (Figure 5-16).

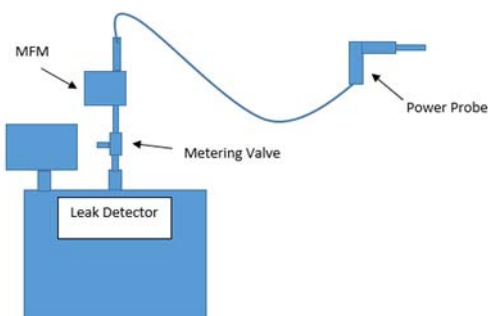

Figure 5-16 Metering Valve Overall Assembly



Figure 5-17 Metering Valve Assembly

- | | |
|--------------|--|
| Item A. (2X) | Description: NW25 to 1/4 NPT stainless steel male pipe adapter
Make: Agilent Technologies Inc. - Agilent part number: KAMP250250S |
| Item B. (2X) | Description: 1/4 NPT to 1/4" tubing adapter
Make: Swagelok - Swagelok part number: SS-4-TA-1-4 |
| Item C. (1X) | Description: 316 stainless steel very fine metering valve, 1/4" swage, 0.004 max
Make: Swagelok - Swagelok part number: SS-SS4 |

Assembly notes:

- Apply Teflon pipe tape onto threads of item B to ensure proper seal with minimal leakage.
 - When connecting item B. to item C., push in 1/4" pipe as far into nut as can be allowed. Then snug nut to finger tight torque. Using a 9/16" wrench, turn nut 1 and 1/4 turns ($360^\circ + 90^\circ = 450^\circ$ total) for proper crush seal with the ferrule inside.
 - This fine metering valve is the same type of valve as used in the Agilent sniffing power probe. If desired, that valve may be taken out of the power probe and reassembled in a similar technique to the one described here.
3. Connect the Power Probe to the mass flow meter.
 4. Connect the mass flow meter RS232 serial port cable to the leak detector serial port located in the back of the unit.

5. Place system into Test and ensure the test port pressure adjusted between 5E-1 Torr 1 Torr (750 mTorr preferred).
6. Perform an internal calibration.
7. Perform an external calibration using the sniffing probe (Figure 5-18) by:
 - a. Selecting **Calibration > Calibrate With > External Leak**.
 - b. Entering the value of the external calibrated leak. Keep the probe at the inlet of the standard leak.
 - c. Pressing **Calibrate**. The system performs an instant calibration in 2 seconds.

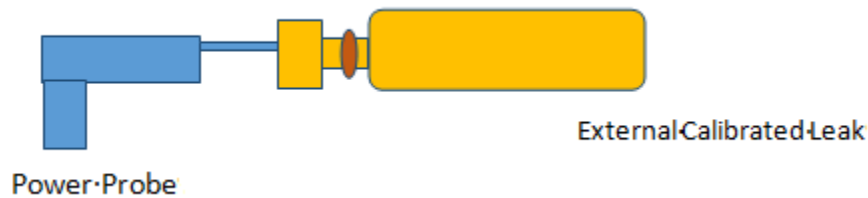

Figure 5-18 External Sniff Calibration Setup

8. Select Test Configurations > Applications Setup.
9. Select **PPM Sniff Method > Application Setup**.
10. Select the **MFM** option.
11. Select **Serial Port** - This establishes RS232 communication between the *MFM* and the leak detector.



The Calibration button on the PPM Sniff application is only to calibrate using a known PPM mixture.

The leak detector is now ready to measure the concentration of Helium in PPM.

5.1.3.10.5 Mass Flow Meter Setup Configuration

Figure 5-19 depicts the connection required to use the Alicat mass flow meter in a test setting. This setup connects from the leak detector test port to the fine metering valve assembly, to the mass flow meter (fitted on both ends with 1/4" NPT NW25 fitting (Agilent part number KAMP250250S), to the hose. This series is important to be fitted in this order to ensure optimal helium response time. Instead of this setup using the purchased metering valve, the operator may choose to use the setup outlined in Figure 5-20, though that configuration can be awkward to hold as a probe. The mass flow meter must be kept above a metering valve, whether the sniffer probe, or the fine metering valve described. This keeps the mass flow meter close to atmospheric pressure, ensuring maximum accuracy.



Figure 5-19 Alicat Scientific Mass Flow Meter Supported Method of PPM Testing

The hose may be connected to the inlet side of the mass flow meter. One connection technique is described here, if you desire to purchase the Agilent sniffer power probe. 1/16" ID hose may be used alone, by itself as a sniffing probe, though it will not have a handle.



Figure 5-20 Hose Fitting Connection

Agilent part number R0305, an adapter from KF25 to 3/16" ID hose may be purchased as part of the power probe kit, Agilent part number K95565305, the entire power probe sniffer assembly. The molded plastic casing of the power probe may be re-purposed by removing the valve and copper tubing, and inserting plain 1/8" ID hose into the shell of the gun. Remove the screws holding the case together using a 7/64" Allen key.

Connecting from 3/16" tubing to 1/16" tubing may be accomplished using McMaster-Carr part number 2808K105. 1/16" tubing should be used as the long line sniffer in this application, not the thicker 3/16" ID tubing. The thinner tubing gives a faster response time for a helium signal. 3/16" ID tubing may be purchased as McMaster-Carr part number 6516T53. This tubing should only be used as an adapter section or as use if not using a mass flow meter. The mass flow meter restricts flow speed, requiring a thinner tube to be used for a quick response time. 1/16" ID tube may be purchased as McMaster-Carr part number 6516T62.

Since a thin hose is required without a fine metering valve on the top of the system, if the operator already has a power probe handle that is not in use, the gun portion of the probe may be disassembled, striped of all valves and copper tubing, and reassembled with a 1/16" hose inside. It is important, however, not to have another metering valve in series above the mass flow meter. This is for optimizing response time. Of course, this only provides a convenient handle. A naked hose may be used for sniffing.



Figure 5-21 Re-purposing a Power Probe for Thin Hose Without a Regulator

5.1.3.10.6 Measuring PPM of Helium with a non-Alicat Scientific brand Mass Flow Meter

- ❑ Scientific confidence added through accurate computation of both helium leak rate, and gas flow rate.
- ❑ Does not require use of known PPM gas mixture (though use is suggested to check calibration).
- ❑ Risk of choosing a mass flow meter that is not in the proper range. The mass flow meter selected should be in the range of SUGGESTED 0 to 1 SLM (equivalently, 0 to 1000 SCCM).



The smallest mass flow meter that may be used while still functioning. It could be as small as 300 SCCM, though this flow rate may not be capable of reading mass flow when measuring flows of mobile unit leak detectors (units with larger roughing pumps).

Alternatively, if using a mass flow meter that is not supported by the leak detector software (anything other than Alicat Scientific brand mass flow meter):

1. Attach the mass flow meter in series above the Agilent power probe sniffing gun (Agilent part number K9565306).
2. Attach the mass flow meter to the sniffing gun through use of a KF to compression port adapter, 1/8" to NW25 (Agilent part number KCP250125), if using the power probe as the metering valve (Figure 5-22).
3. Perform an internal calibration.
4. Perform an external calibration using the sniffing probe by:
 - a. Selecting **Calibration > Calibrate With > External Leak**.
 - b. Entering the value of the external calibrated leak. Keep the probe at the inlet of the standard leak.
 - c. Pressing **Calibrate**.

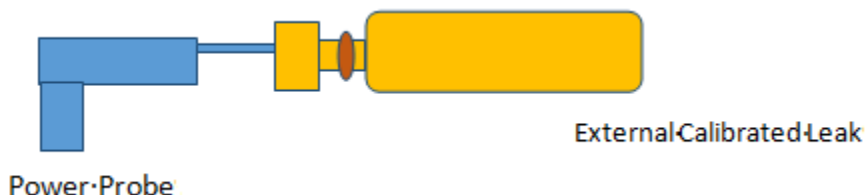

Figure 5-22 External Sniff Calibration Setup

5. Select **Test Configurations > Applications Setup**.
6. Select **PPM Sniff Method > Application Setup**.
7. Ensure the system is in *Test* and the test port pressure adjusted between 5E-1 Torr 1 Torr.
8. Select the **MFM** option.
9. Input the flow rate - SCCM displayed from the MFM/MFC controller.

The leak detector is now ready to measure the concentration of Helium in PPM.

To make the connection between the power probe sniffing gun and the mass flow meter:

1. Fit the mass flow meter on the low-pressure end with an NW25 vacuum fitting (Figure 5-23).



Figure 5-23 Compression Port

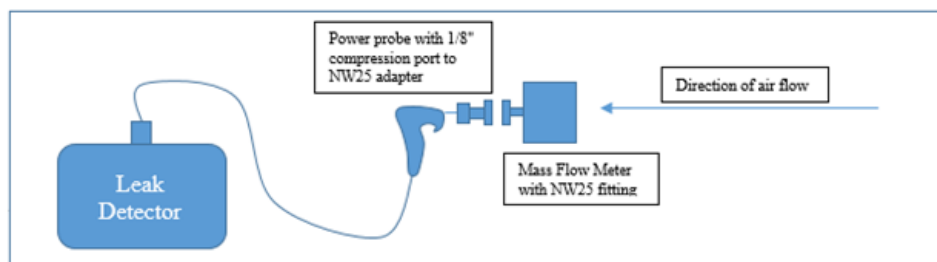

Figure 5-24 Probe Configuration

2. Measure the flow rate. Write this number down for later.
3. Vent the system and remove the mass flow meter. If the test port pressure remains constant, the flow rate should not change. Do not adjust the metering valve on the back of the sniffing power probe without recalibrating.
4. Vent the leak detector and remove the mass flow meter, if desired for faster helium signal response time.
5. Install the power probe back onto the leak detector and put the system into **Test**.

5.1.3.10.6.7 Parts per Million (PPM) Application Notes

Theory

Parts per million (PPM) of helium may be measured using a helium leak detector that is either used in conjunction with a mass flow meter, or is calibrated using a known concentration (PPM) of helium. PPM of helium is described as the flow rate of helium divided by the flow rate of total gas, multiplied by 100. If there are 5 moles of helium, and 999,995 moles of other gas, then the concentration is 5 PPM helium. This is a typical concentration of helium at sea level on earth.

A helium leak detector by itself does not measure PPM. A helium leak detector measures a leak rate of helium in units of (atm cc)/sec which is a measure of mass flow rate (cubic centimeter volumes filled with 1 atmosphere of pressure that flows into the leak detector inlet every second). The unit atm, atmospheres, is the same type of unit as Torr, a measure of pressure. 1 atm = 760 Torr. Additionally, cc, cubic centimeters, is the same type of unit as liters. 1 liter = 1000 cc.

The helium leak rate measurement taken from the leak detector by itself does not provide enough information to describe the PPM of helium present. To get that information, the mass flow rate of helium must be known and the mass flow rate of total gas passing into the leak detector must be known. An external mass flow meter may be used for this measurement. With a known mass flow rate of helium and a known mass flow rate of total gas, a simple percentage of helium in the total gas can be computed:

$$\text{Concentration [PPM]} = \left(\frac{\text{leak rate} \left[\text{atm} \cdot \frac{\text{cc}}{\text{second}} \right]}{\text{total gas flow rate} \left[\text{atm} \cdot \frac{\text{cc}}{\text{second}} \right]} \right) * (1E6) \uparrow$$

The additional 1E6 converts the fraction into a part per million.

This page intentionally left blank.

Section 6. Settings Screen

6.1 Settings Menu

The Settings Menu configures the leak detector for a desired appearance and functionality.

The Settings Menu consist of the following:

- ❑ *Main Settings* - Date and Time setup, Leak Rate and Pressure Units selection and Language selection.
- ❑ *Screen& Output Settings* - Bar graph appearance, Leak Rate Ranging Selections and Analog Output selections.
- ❑ *Remote Control* - Wireless activation and channel selection.
- ❑ *Passwords and Restrictions* - Restriction level and password selection plus leak detector control lockouts.

6.2 Main Settings

To open this screen select **Menu tab > Setting > Main Settings**.

With the Settings Menu open, select the Main Settings Menu as shown below:

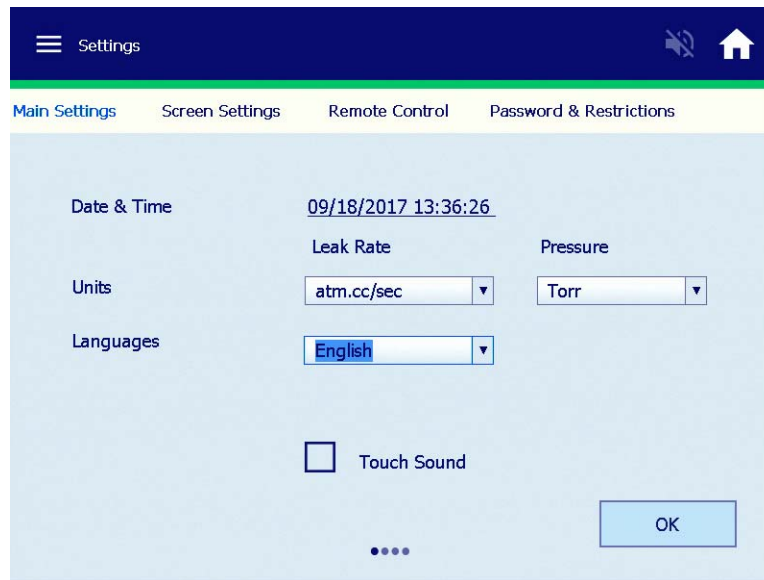

Figure 6-1 Settings: Main Settings

Buttons and Fields

Date & Time

Display and configure the current date and time.

Units

Select leak rate units:

- atm-cc/sec
- mbar-l/sec
- Torr-l/sec
- Pa-m3/sec.,
- Cubic- ft./yr.

Select pressure units:

- Torr
- Mbar
- Pascal

Language

Selections available include:

- English
- French
- Spanish
- German
- Mandarin
- Korean
- Japanese
- Russian

6.2.1 Configure Date and Time

To configure the Date and Time screen:

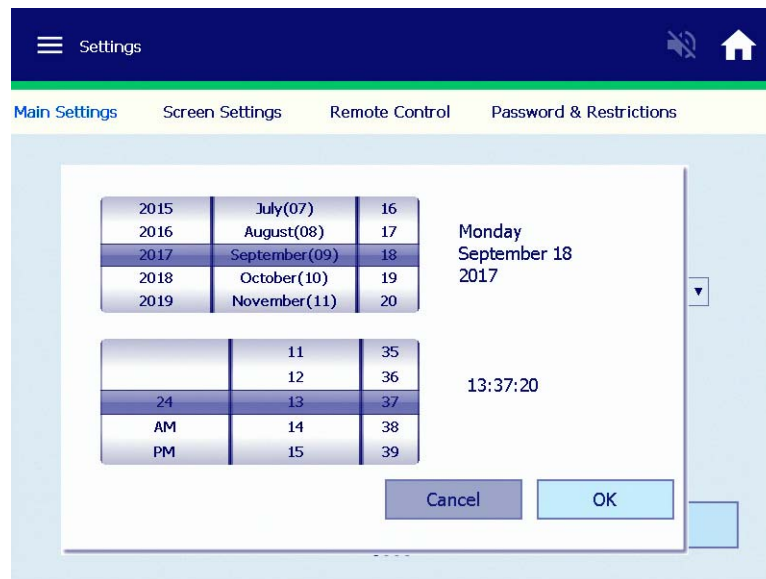

Figure 6-2 Date and Time

1. Activate a field by touching within the date and time field.
2. Scroll and select the correct date and time.
3. Press **OK** to exit the screen or continue with Units and Languages.

Select **Touch Sound** for an audible touch tone for all touch screen selections and inputs.

6.2.2 Screen Settings

The Screen Settings is a personalized menu that configures the leak detector's bar graph, leak rate ranging and the analog output voltage type.

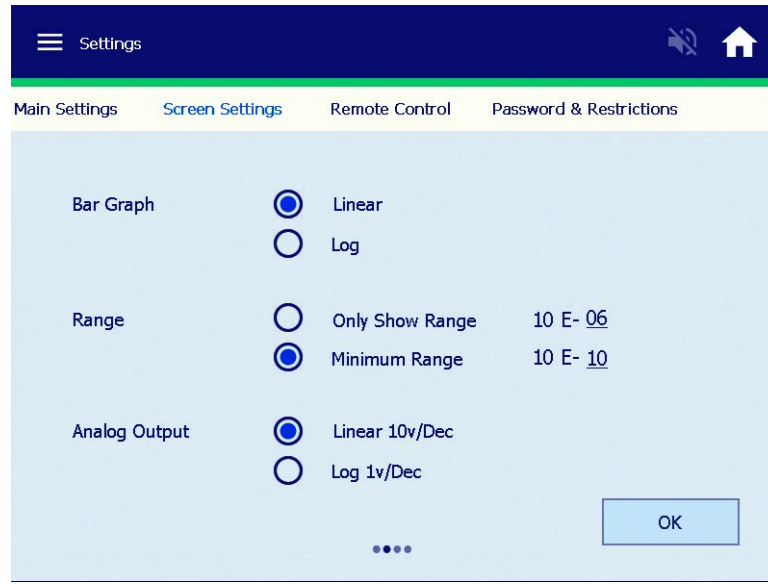

Figure 6-3 Settings: Screen Settings

Buttons and Fields

Bar Graph

Configures the bar graph:

- ❑ *Linear Scale* - The linear bar graph leak rate appears across the top of all screens when selected. In the *Linear Bar Graph* display mode, the bar graph display represents the mantissa of the leak rate, spanning from 0 to 10. The numerical display (located to the upper right of the bar graph) indicates the leak rate exponent value. This mode offers exceptional resolution within a decade.
- ❑ *Log Scale* - The log bar graph leak rate appears across the top of all screens. In *Log Bar Graph* display mode, the bar graph display represents the entire leak rate range of the leak detector, spanning from E-11 atm cc/sec to E-4 atm cc/sec. The numerical display (located to the upper right of the bar graph) is not lit in this mode.

Range

Configures *Minimum Range* (Range Stop) and *Only Show Range* (Manual) *Leak Rate* options

- ❑ *Only Show Range* - Configures the leak detector so that it only displays the pre-selected decade entered in the manual range variable field. For example, if the manual range feature was enabled and the manual range variable was set to E-6, then the leak rate decade displayed on the LED bar graph during testing would be the E-6 atm cc/sec range only. This feature is useful when the concern is only with monitoring the leak rate measurement within a single decade.

For example, if the Only Show Range feature was enabled and the Only Show Range variable was set to 10^{-06} , then the leak rate decade displayed on the LED bar graph during testing would be the 10^{-06} atm cc/sec range only.

- ❑ *Minimum Range* - Configures the leak detector so that it only auto-ranges down to the pre-selected decade. To allow auto-ranging to the maximum sensitivity of the system, turn *Maximum Range Off*.

This feature is useful when a product specification is more than one decade less stringent than the actual sensitivity of the leak detector. If the leak detector is capable of displaying full scale < E-11 atm cc/sec, but the test specification is only in the E-7 atm cc/sec range, then setting the range stop to E-8 atm cc/sec would reduce the test cycle time by eliminating the need for the leak detector to reach its most sensitive scale during each test cycle.

Activating the Minimum Range extends the sensitivity requirements for calibration, thus eliminating unnecessary calibration errors (see Table 2-4).

NOTE



Activating the range stop extends the sensitivity requirements for calibration, thus eliminating unnecessary calibration errors (Table 6-1).

Table 6-1 Range Stop/Sensitivity Requirements

Range Stop	Max Gain	MDL
OFF	6.9	5.00E-12
ON at		
-11	6.9	5.00E-12
-10	10	5.00E-11

Table 6-1 Range Stop/Sensitivity Requirements

Range Stop	Max Gain	MDL
-9	20	5.00E-10
-8	50	5.00E-09

6.2.3 Analog Output

Analog Output

Configures the analog outputs:

- Linear 10 V/DEC
Linear output running from 0 to 10 V for each decade. Figure 6-4 shows the linear output voltage as a function of leak rate.
- Log 1 V/DEC
Log output at 1 V per decade. Figure 6-5 shows the log output voltage as a function of pressure.

NOTE



*For added accuracy add .06 to V_{out} .
Leak Rate = $10^{V_{out} + .06} / 10^{11}$.*

Bar Graph

Configures the bar graph:

- Linear Only
The linear bar graph leak rate appears across the top of all screens when selected. In the Linear Bar Graph display mode, the bar graph display represents the mantissa of the leak rate, spanning from 0 to 10. The numerical display (located to the upper right of the bar graph) indicates the leak rate exponent value. This mode offers exceptional resolution within a decade.

Agilent Technologies Helium Leak Detector

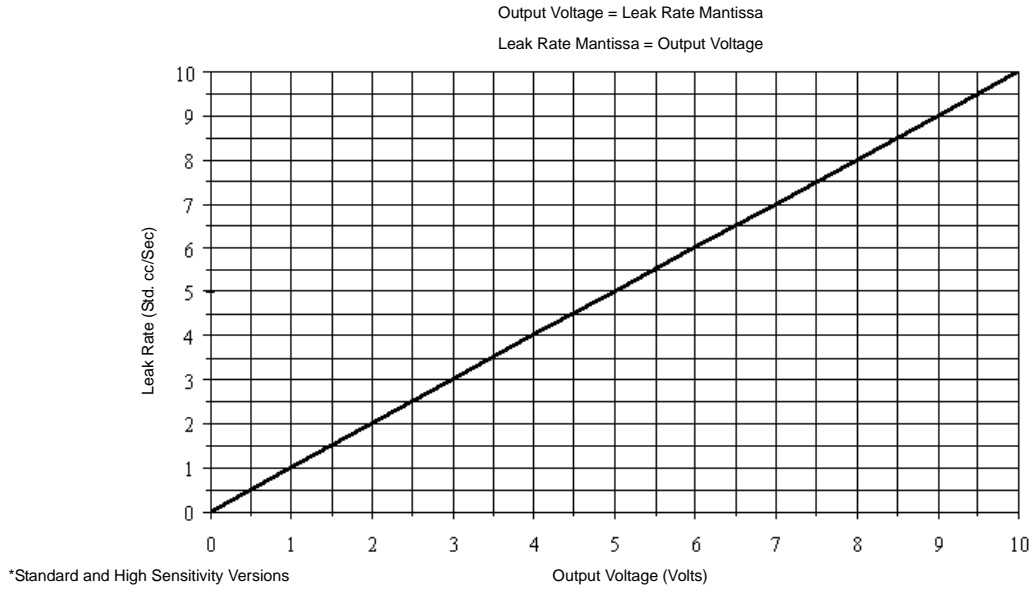

Figure 6-4 Leak Detector Linear Output Voltage

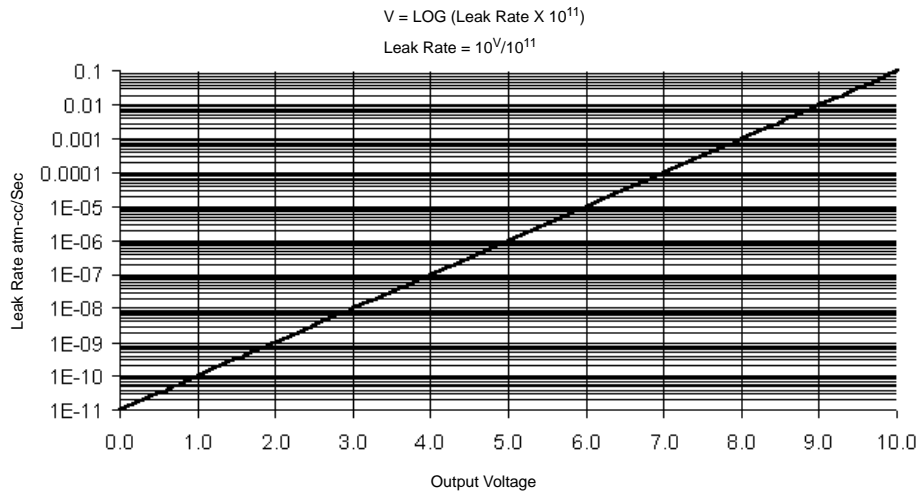

Figure 6-5 Leak Detector Logarithmic Output Voltage

6.2.4 Remote Control

The remote control feature is a factory or field installed wireless option that establishes communication between the leak detector and Agilent's wireless hand-held remote control.

Use this menu to activate the leak detector's wireless baseboard option and to assign the RF channel number that the remote hand-held device will link with.

- Communications with the leak detector
- Control of the leak detector

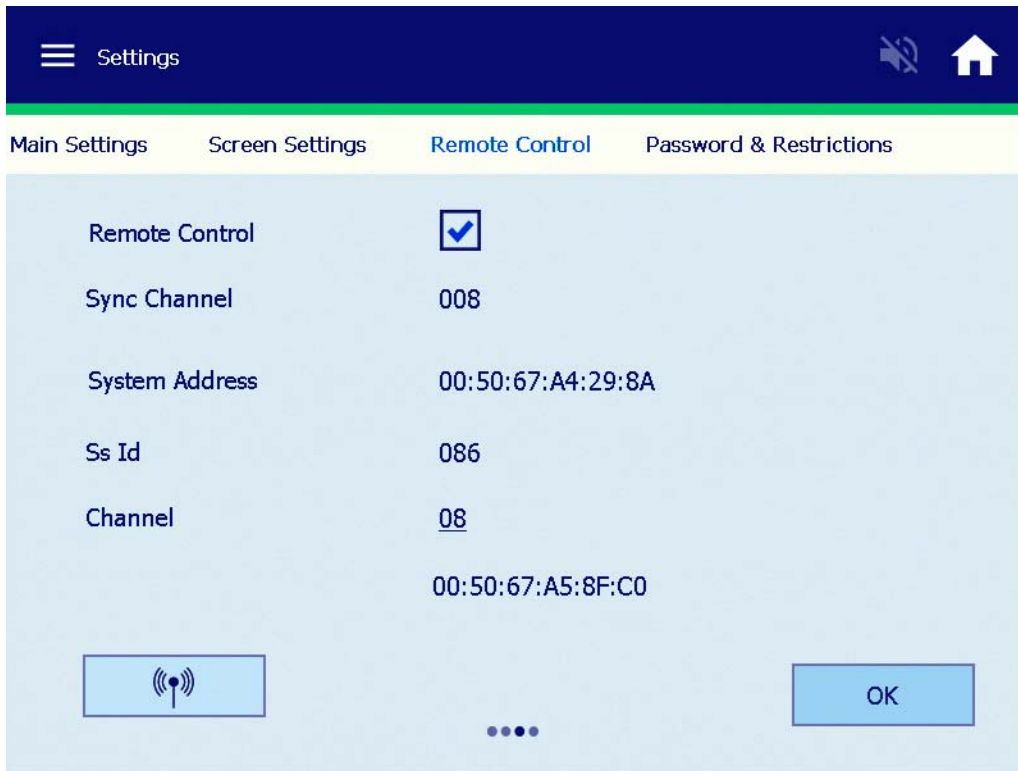

Figure 6-6 System Settings: Remote Settings

6.2.5 Password and Restrictions

The Password and Restrictions Menu is an optional configuration that protects the setup of the leak detector. The factory and operational setups of the leak detector significantly affect the performance of the leak detector and must only be accessed by trained service personnel. This menu also allows protection from unintentional calibrations and accidental operator input while the machine is unattended or under test.

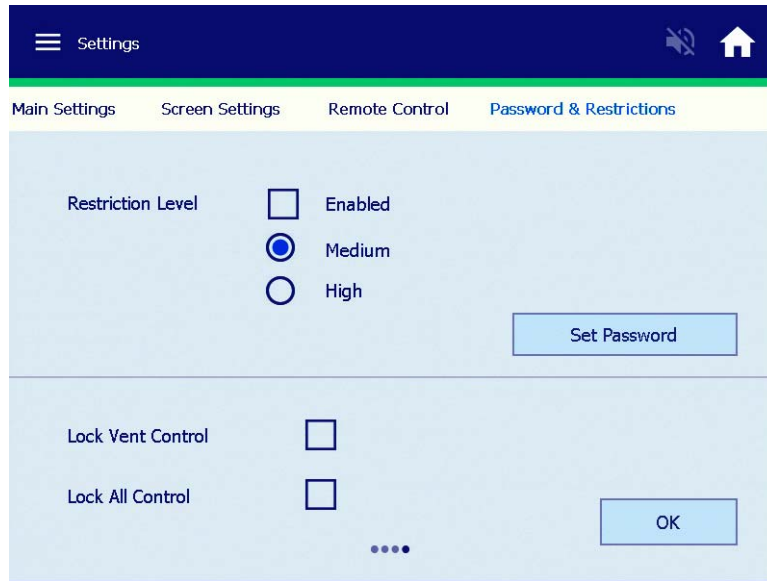

Figure 6-7 Systems Settings: Password and Restrictions



VENT, TEST and ZERO buttons are still accessible in all password levels.

Buttons and Fields

Restrictions

Activates/deactivates the password function:

- Medium*: Allows operation (*Home Screen*) of the *Test, Vent & Zero* functions. Locks out all menu selections other than the *Calibration Menu*. Allows *Internal & External Calibration*.
- High*: Locks out all menu selections (*Home screen* only)

Set Password

Changes the password. Enter up to six numeric values for the password and confirm the password selection. An empty entry is not allowed. If no password is entered, the old password is used. The default password from the factory is 777777. You need this when changing to a new password.



The password can also be read through the RS-232 port in the event of a lost password. See Section A “Communications Protocol” on page 139.

Lock Vent Control

Disables the *VENT* button. This option prevents accidental system venting during test while under remote or PLC control. The *Vent Lock* feature is not active when the *Auto Sequencer* is on.

Lock All Control

Disables the *Test*, *Vent* and *Zero* buttons. This option prevents accidental system venting, testing, system hold and Zeroing during test while under remote or PLC control.

6.3 Wireless

- ❑ Information relating to wireless communications.

MAC Address

Two MAC addresses appear on this screen:

- ❑ The MAC address at the top of the screen is the leak detector MAC address.
- ❑ The MAC address above the hand held button is the MAC address of the hand held device.

SYNC Channel

For informational and factory debug purposes only.

SS ID

Displays the SS ID number, factory set to 086, for informational and factory debug purposes only.

Channel

Click the button and a keypad appears to configure the channel (1-19) that the unit uses to communicate with the wireless remote. Up to 10 wireless remotes and leak detectors can be communicating in a common area at a time.

Section 7. Maintenance Screen

7.4 Maintenance Menu

The Maintenance Menu allows you to view or change the settings/parameters of the leak detector, including

- ❑ General
 - ❑ Internal Calibrated Leak
- ❑ Manual Tuning
 - ❑ Spectrometer tuning parameters
- ❑ Valve Control
 - ❑ Valve status
- ❑ Pump
 - ❑ Primary/Roughing Pump configuration
- ❑ Gauge
 - ❑ Test Port TC calibration
- ❑ System Defaults
 - ❑ Reset Turbo & Filament hours

This Maintenance menu (General) allows you to view and input the value and parameters of the installed internal calibrated leak. A Software Update utility is also now available.

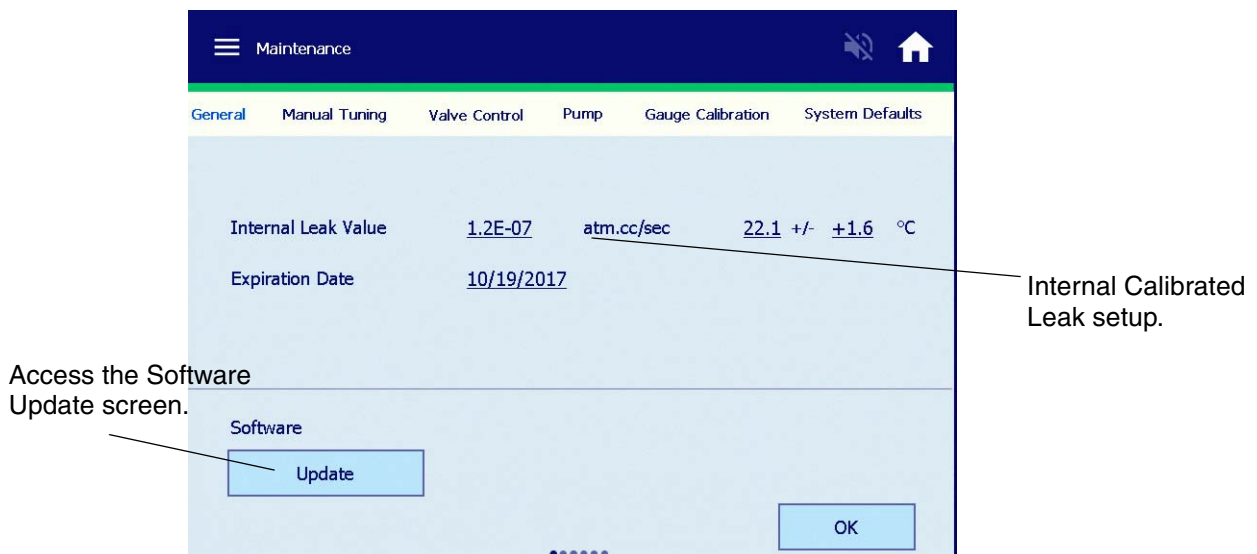

Figure 7-1 Maintenance General

7.4.1 Software Update

Contact Agilent Customer Service/Technical Support for the latest software upgrade.

The software update utility is necessary when added features and software upgrades are needed. A USB jump drive is all that is needed. The USB port is located in the back of the leak detector Figure 7-2.

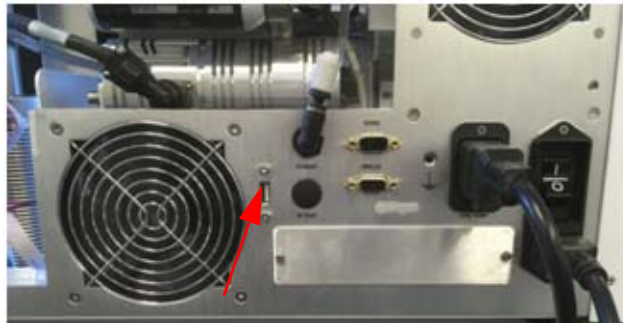

Figure 7-2 USB Port

1. Select the **Software Update** option.

You are prompted to insert the USB drive into the back of the leak detector (Figure 7-3).

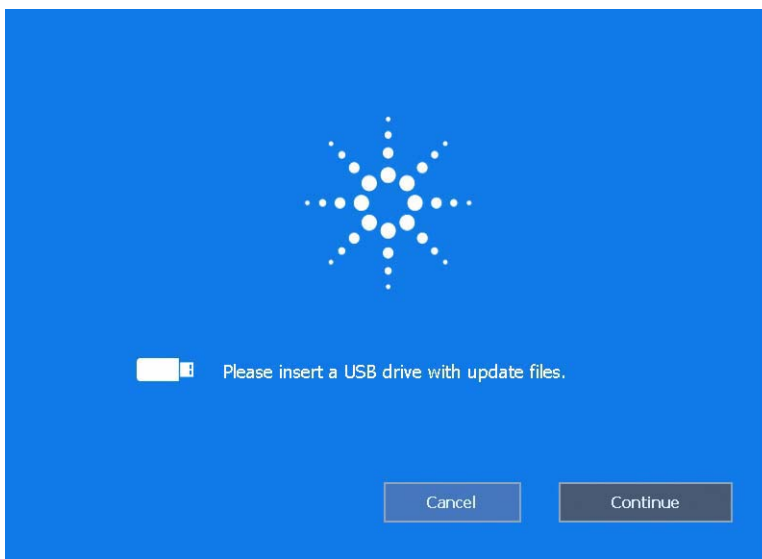

Figure 7-3 Insert USB Drive

2. Inset the USB drive.
3. Select **Continue**.

The software update takes no more than 15 seconds.

4. Power off the leak detector as instructed and power back on.
5. Verify in the *System Information* Menu that the correct software was installed

7.4.2 Internal Calibrated Leak Setup

Use this screen to set the *Internal Leak Value*, *Temperature Coefficient* or *Expiration Date*.

The *Internal Calibrated Leak* screen appears (Figure 7-4).

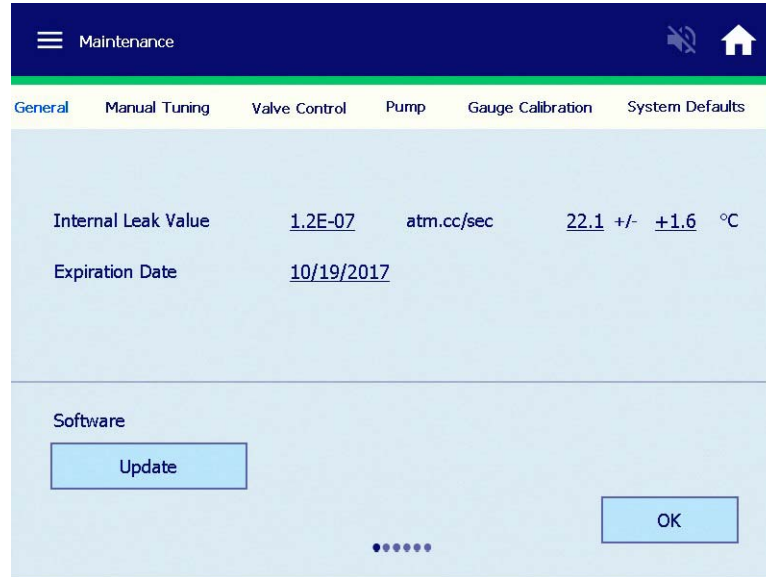

Figure 7-4 Internal Calibrated Leak

To use this screen:

1. Press/tap the underlined/highlighted field to activate its associated keypad. A keypad appears (Figure 7-5).

Agilent Technologies Helium Leak Detector



Figure 7-5 Internal Calibrated Leak Keypads

2. Enter the required values as shown on the calibrated leak label or calibration certification.
3. Repeat step 1 and 2 for each desired item.
4. Press **OK** to exit the screen.

The value of the internal calibrated leak, as shown on the *CALIBRATION Menu*, is compensated for temperature using the calibrated leak temperature sensor. The calibrated leak is not compensated for temperature if any of the following conditions exist:

- ❑ The temperature sensor on the calibrated leak fails or there is a cable connection problem.
- ❑ The temperature sensor reading is out of the operating range. The operating temperature range is from 10.0 to 45.0° C (50 to 113° F).
- ❑ The internal calibrated leak is not a E-7 or E-8 range leak.



Figure 7-6 Calibrated Leak



The actual value and information of the internal calibrated can be found on the calibration certificate that shipped with the leak detector or shipped with the field installed calibrated leak. The label on the internal calibrated contains also contains all the necessary information as shown in Figure 7-6.

7.4.3 Manual Tuning

- Press **Manual Tuning** and the Manual Spectrometer Tuning screen appears (Figure 7-7).

Use this screen to view and manually adjust the parameters of the ion source in the spectrometer for a maximum helium signal.

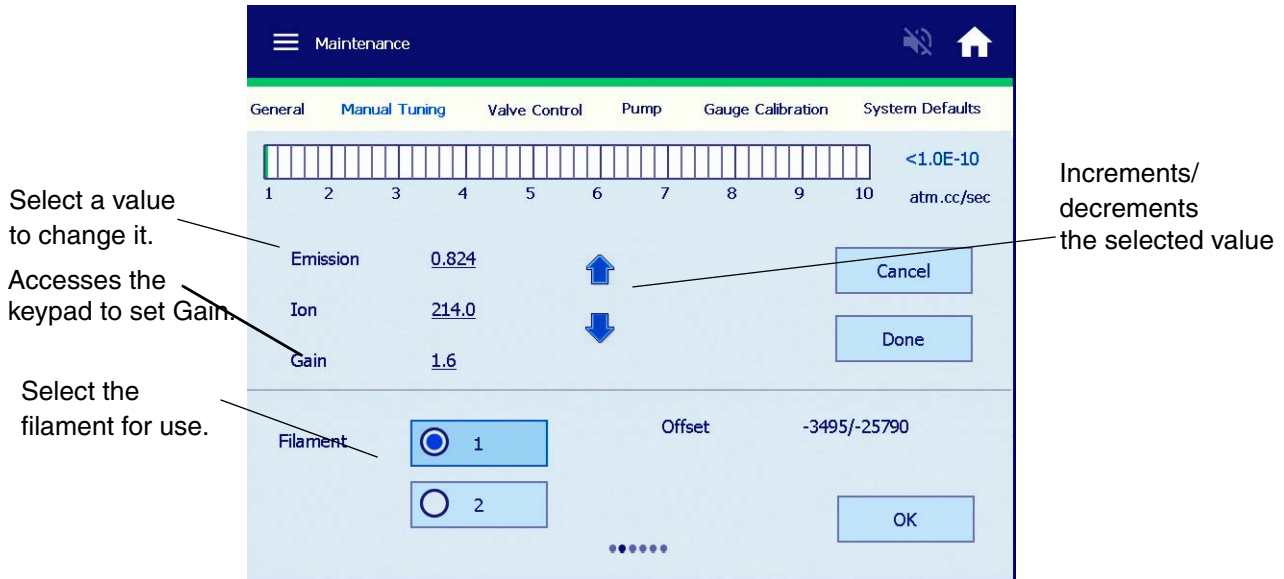

Figure 7-7 Manual Tuning

- | | |
|------------------|---|
| Emission Current | Displays the value of the existing Emission current of the spectrometer Ion Source and allows for emission current adjustment. The emission current parameter tunes the leak detector, maximizing the leak detector output for a peak helium signal.

Typical Emission current values range from 0.6 mA to 1.2 mA. |
| Ion Voltage | Displays the current ion voltage value of the spectrometer Ion Source. The ion voltage parameter tunes the leak detector, maximizing the leak detector output for a peak helium signal.

Typical ion voltage values range from 205 VDC to 240 VDC. The ion voltage value is automatically adjusted and set during the full calibration routine. |

Filament Switches between Filament 1 and 2. The filament selection can be performed manually, but occurs automatically if the current operating filament burns out. A calibration routine is recommended every time the operating filament is changed.

The change appears on the Home and System Information screens and *C* flashes on the Home screen to indicate that calibration is required.

Gain Displays the current value of the Gain of the system. Gain is used to scale the indicated value of a known leak to agree with a known correct value. The gain parameter is adjusted after the leak detector has been tuned to helium. It is automatically set by the Calibrate Procedure.



Changing Gain changes Zero by the same percentage, which can affect system transfer points.

Typical gain values range from 0.5 to 3.0. The higher the gain, the more noise shows up in the least sensitive range.

To change a *Gain* parameter:

1. Press the numerical Gain value.

The numerical value has a grayed out/dimmed appearance.



*For all tuning parameters, press **Cancel** to revert back to the original value or press **Done** to initiate/store the desired value.*

2. Press the Up or Down arrow to peak the helium signal.
3. Press **Done** to accept the changes and to store the new parameter value in the leak detector memory.
4. Press **OK** to exit the screen and return to the Home screen.

To manually tune the leak detector:

1. Place the system in TEST mode.
2. Navigate to the Calibration and turn the Read Internal Leak - On.
3. Write down the INTERNAL CALIBRATED LEAK value. This value is temperature compensated.
4. Navigate to the Manual Tuning Menu and:
 - Set the GAIN to 1.0.
 - Set the EMISSION to between 0.600 and 0.6500.

Agilent Technologies Helium Leak Detector

- ❑ Adjust the ION value up or down to attain the maximum value. Ideally, the ION value should be between 205 and 240.
 - ❑ Adjust the EMISSION to attain the maximum value. Ideally, the EMISSION value should be between 0.600 and 1.200.
 - ❑ Set the GAIN so that the leak rate on the screen matches the value of the internal leak you wrote down.
5. Navigate to the Calibration Menu and turn the Read Standard Leak - OFF.

7.4.4 Maintenance: Valve Control

Use this screen to monitor and control the valves in the leak detector vacuum system for troubleshooting purposes. See Figure 7-10 on page 123 for an illustration of the leak detector vacuum system.

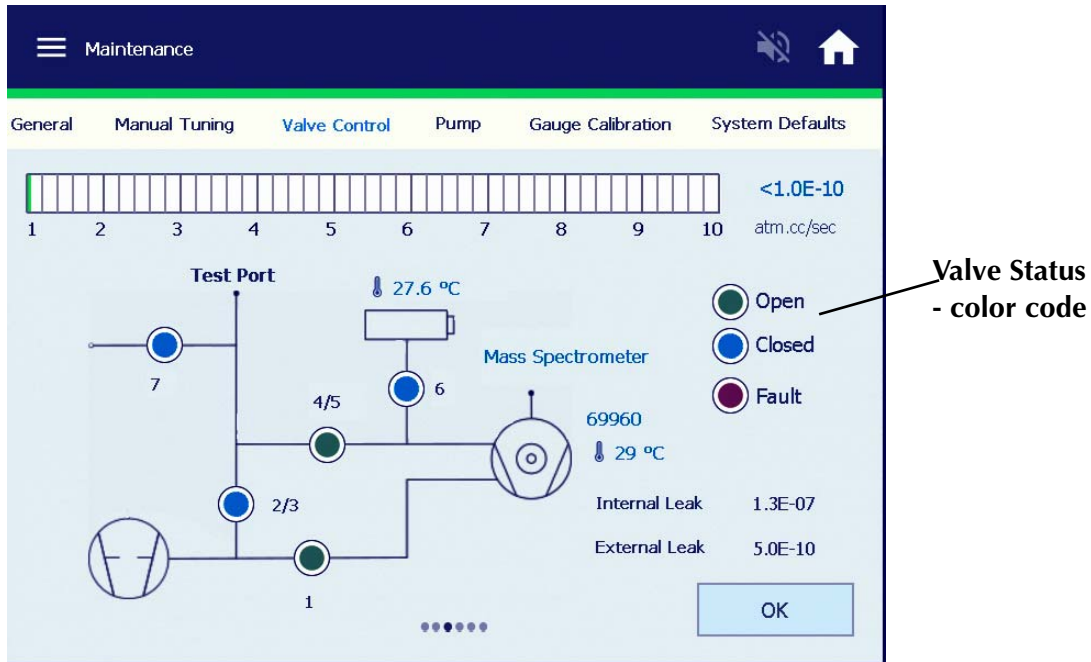

Figure 7-8 Maintenance: Valve Control

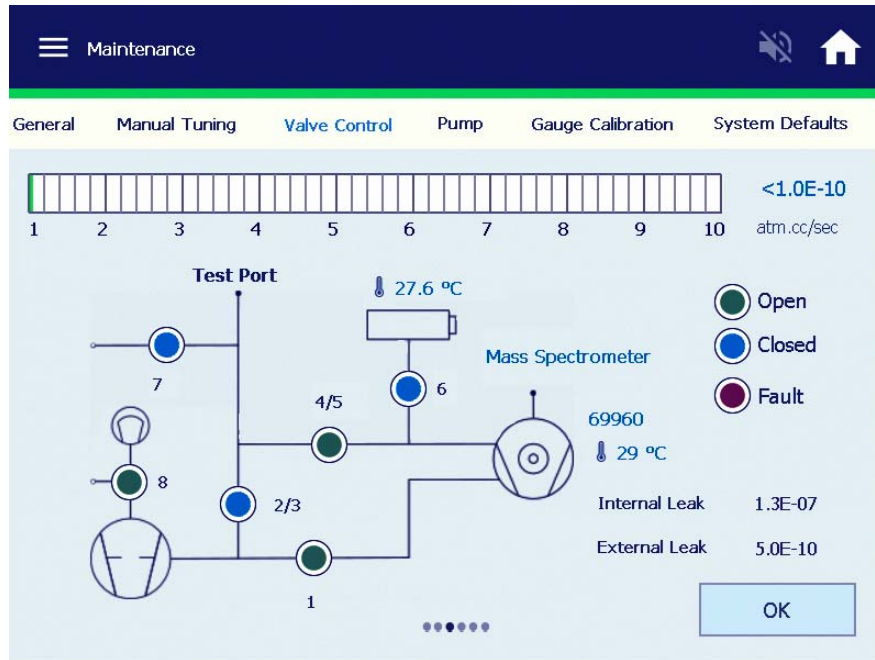

Figure 7-9 Valve Control Models G8610B, G8611B, G8611C, G8612B & G8612C

Agilent Technologies Helium Leak Detector

These models all contain a diaphragm pump as shown above V8.

CAUTION



Manipulation of the valves using the Manual Valve Control screen must only be performed by persons who are extremely familiar with the leak detector as damage to critical components (e.g., spectrometer, turbo) can occur.

Press the circle corresponding to that valve to change the state of a specific valve.

Table 7-1 Leak Detector Valve State Table - Single Mechanical Pump System

Leak Detector Operating State	V1 Foreline Valve	V2/V3 Contra-Flow w Valve Test Mode	V4/V5 Midstage Valve Fine Test Mode	V6 Calibrated Leak	V7 Vent Valve	V8* Ballast Valve	V8* Exhaust Valve
Vent	O	C	C	C	O	C	O
Rough	C	O	C	C	C	C	C
Gross Leak Test	C	O	C	C	C	C	N/A
Contra-Flow Test	O	O	C	C	C	C	O
Midstage Test	O	C	O	C	C	C	O
Hold	O	C	C	C	C	C	O
Sniff	O	O	C	C	C	C	O
Read Std Leak	O	C	C	O	C	C	O

O: Open

C: Closed

Agilent Technologies Helium Leak Detector

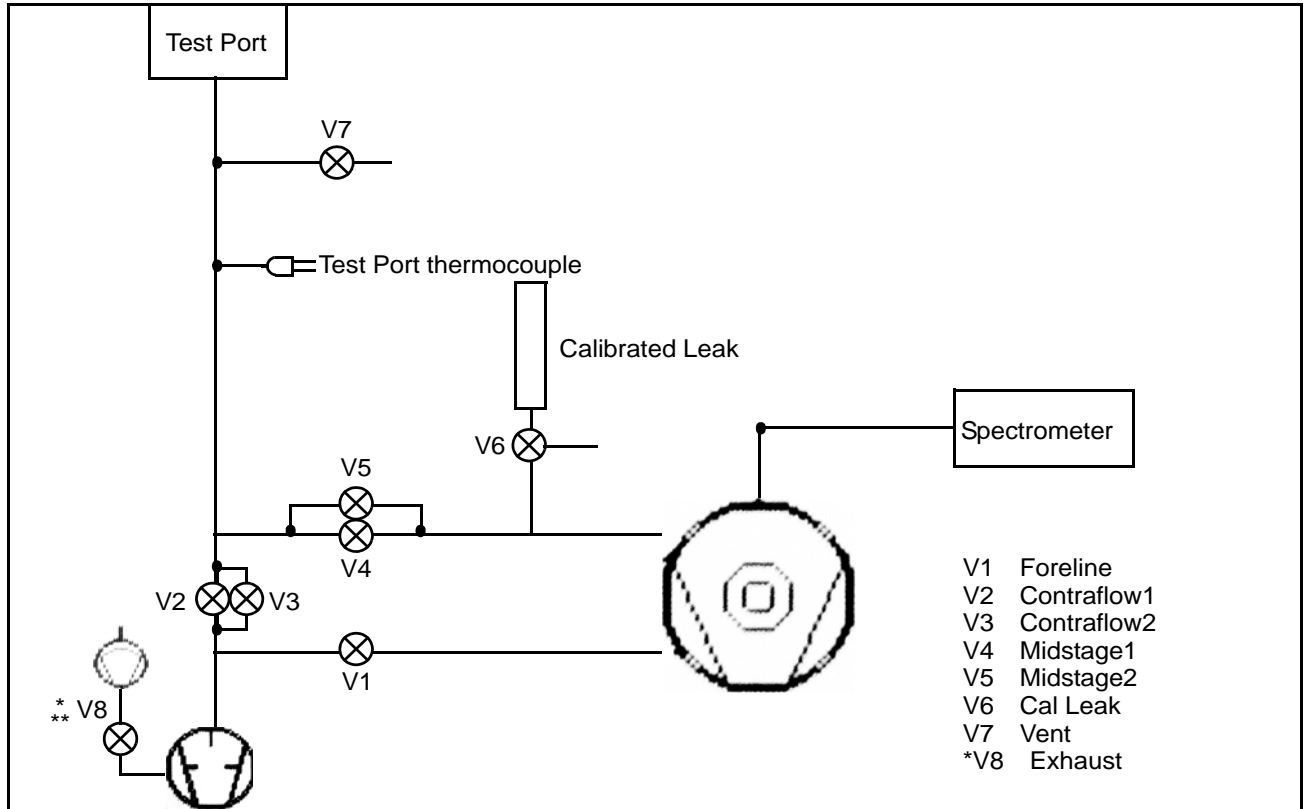

Figure 7-10 Leak Detector Vacuum System Diagram

* Normally open valve, powered closed during all operations. ** Model G8610B, G8611C, G8612C, G8611B during the roughing sequence.

7.4.5 Maintenance: Pump

The Pump Menu screen displays the Fore pump type (Dry or Oil) - Factory configured. Operating hours and Last Service are also displayed.

This menu also displays the installation of a diaphragm exhaust pump and its' operating hours and Last Service Date.



Figure 7-11 Maintenance: Fore Pump

Buttons and Fields

Last Serviced Select the date on which the oil is changed or the tip seal is replaced. The system then tracks the operating hours since the pump was last serviced or when a new fore pump is installed. Lists the Last Service date for the exhaust Pump and operating hours

Enable Exhaust Pump screen This screen appears for dry pump models only. The service date is changeable. Exhaust Pump only for models G8610B, G8611C, G8612C, G8611B and G8612B.

7.4.5.1 Fore Pump Type and Exhaust Pump Activation

The fore pump type and exhaust pump are configured at the factory or can be configured by a service engineer.



When the Last Service date is updated/changed the Operating Hours reset to Zero.

7.4.6 Maintenance: Gauge Calibration

A display of $<1.0E-03$ indicates the pressure is less than the lowest displayable pressure of the TC gauge, which is $1.0E-03$. Use this screen to perform a calibration on the test port thermocouple gauge. Calibrate the thermocouple gauge for the most accurate operation.

- Select Gauge Calibration from the Maintenance Menu selection.

Use this screen to:

- Set a calibration point at atmosphere.
- Set a calibration point at a low vacuum level ($\leq 1E-4$ Torr).



Figure 7-12 Maintenance: Gauge Calibration

Buttons and Fields

Test Port Vacuum Calibrates the thermocouple gauge zero value. Do this at or below $1E-4$ Torr.

Agilent Technologies Helium Leak Detector

Test Port ATM Sets the thermocouple atmospheric value. Perform this operation only when the test port is at atmosphere.

Test Port Pressure and Spectrometer Pressure These values appear on this screen for reference.

7.4.6.2 Test Port Pressure Gauge Calibration Procedure

Calibrates the test port pressure thermocouple gauge. Perform both the *Vacuum* and *Atmospheric Calibration* procedures in the order given.

7.4.6.3 Maintenance: System Defaults

Use this screen to reset *Turbo* hours plus *Filaments 1* and *2* hours and restore system defaults.

This screen displays the on/time hours for the turbo pump and filaments.

When replacing a turbo pump or a filament ensure that the hours are reset. This aids in scheduling an effective maintenance service.



Figure 7-13 Maintenance: System Defaults

Button and Fields

Restore System Defaults

Resets the system back to the original factory configurations:

- Auto Zero<0 - Active*
- Internal calibrated leak rate information will be retained*
- V-gain value as shipped will be retained*
- English Language - default*
- Minimum Range - E-10*
- Restores Setup Wizard*

7.4.6.4 System Information

- Press **System Information** on the Menu screen.

The System Information screen appears (Figure 7-14).

This screen gives details of the installed software version, spectrometer parameters and the turbo frequency.

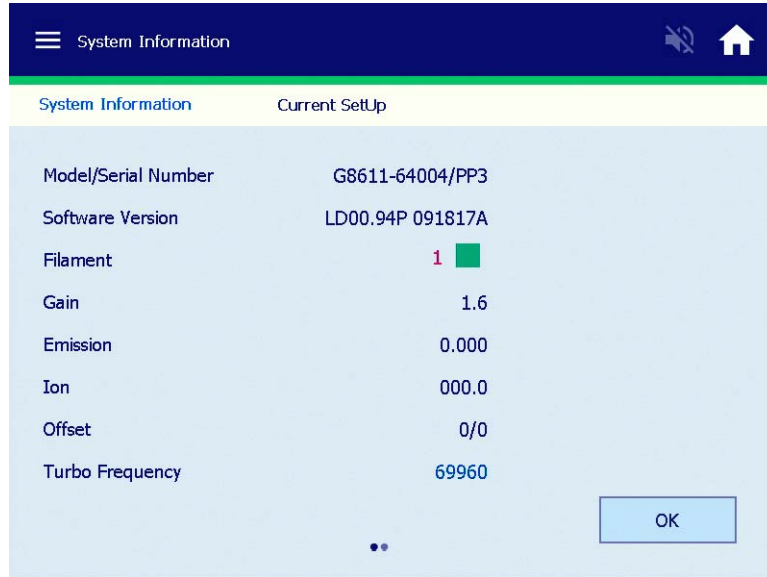

Figure 7-14 System Information

Table 7-2 System Information Screen Conditions

Condition	Display	Description
Ion Source Filament See Section 7.4.3 “Manual Tuning” on page 118.	Filament 1 Off	Filament 1 is selected and not lit.
	Filament 1 On	Filament 1 is selected and lit.
	Filament 2 Off	Filament 2 is selected and not lit.
	Filament 2 On	Filament 2 is selected and lit.
Gain	Gain (Gain Value)	Displays the gain that applied to the leak rate. The actual helium signal is multiplied by the gain value to read the correct, calibrated leak rate.
Software Version and Agilent Web site		Shows the software version of the CPU board.

7.4.1 Current Setup Menu

Details of the current leak detector setup are displayed. Reject and audio set point status, auto sequencer status & split flow. The calibrated leak setting, leak rate range settings and vent lock out status.

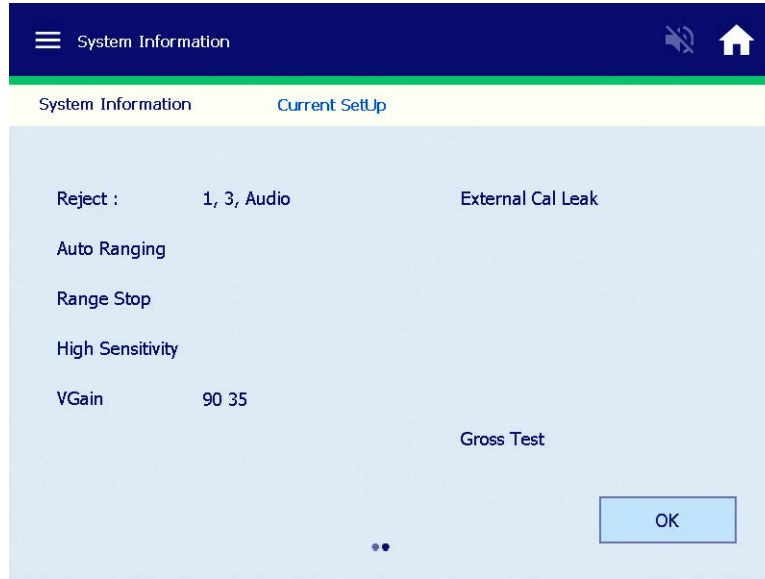

Figure 7-15 Current Setup Screen

Table 7-3 Current Setup Screen Conditions

Condition	Display	Description
Audio Set Point See Section 7.4.1 "Current Setup Menu" on page 128.	Audio Set Point: Active	Audio Set Point is active.
	Audio Set Point: Inactive	Audio Set Point is inactive.
Auto Sequencer See Section 7.4.1 "Current Setup Menu" on page 128.	Auto Sequencer: On	Auto Sequencer (automatic test cycle) is enabled.
	Auto Sequencer: Off	Auto Sequencer (automatic test cycle) is disabled.
Calibration Set-Up See Section 4 "Calibration Screen" on page 65.	Int Cal Leak	System is set to calibrate to the internal standard leak.
	Ext Cal Leak	System is set up to calibrate to an external standard leak.
Leak Rate Range See Section 4 "Calibration Screen" on page 65.	Auto Ranging	System is set to auto range through the leak rate scale.
	Manual Ranging	System is set for manual range control.

Table 7-3 Current Setup Screen Conditions (Continued)

Condition	Display	Description
Range Stop See Section 4 “Calibration Screen” on page 65.	Range Stop -[Exp]	System is set to display the most sensitive leak rate range, 10 ^[Exp] . The range stop line shows only if range stop is on.
Reject Set Point See Section 7.4.1 “Current Setup Menu” on page 128.	Reject# 1,2,3,4 Active	Reject set points displayed are active; this line is blank when all set points are disabled or inactive.
Split Flow See Section 5.1.3.9 “Split Flow” on page 89.		Shows split flow, only if the feature is turned on. To change the status, go to the Advanced Parameters screen.
Vent Lockout Status See Section 3.1.2 “Menus Screen” on page 63.		Shows the status of the vent lockout feature only if it is on. To change the status of the vent lockout feature, go to the Control Panel access screen.

7.4.1.5 Current Setup

The current setup menu displays all activated parameters including selected applications.

7.4.1.6 Turn Off

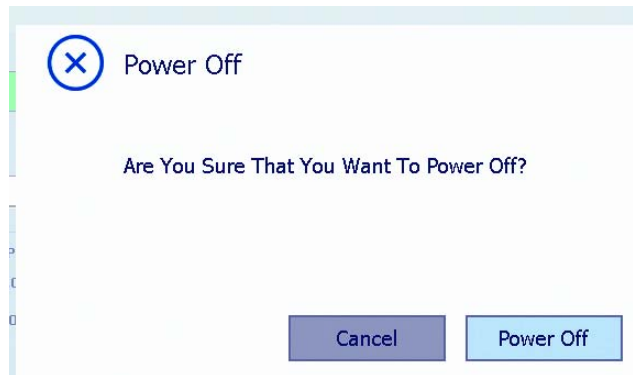

Figure 7-16 Power Off

This feature provides a soft shut down for the CPU and turbo pump prior to turning off the main power/circuit breaker switch.



This power off feature provides a two-minute braking procedure for the turbo pump. This aides in turbo pump life and for safe transportation of the leak detector

1. Select **Power Off**.
2. Wait for the *Status Bar* to fill to 100%.
3. Press **OK** and turn off the power switch located in the back of the leak detector.

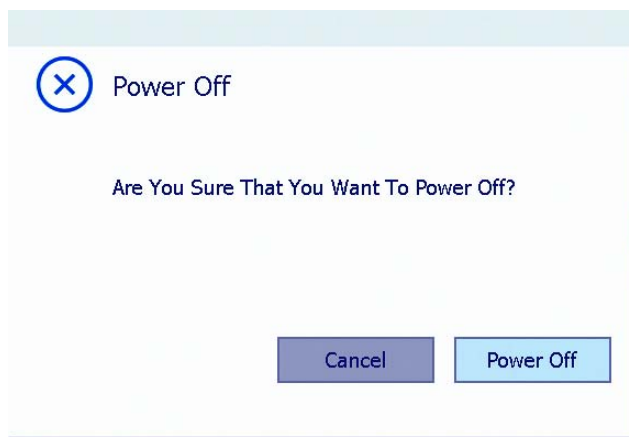

Figure 7-17 Power Off

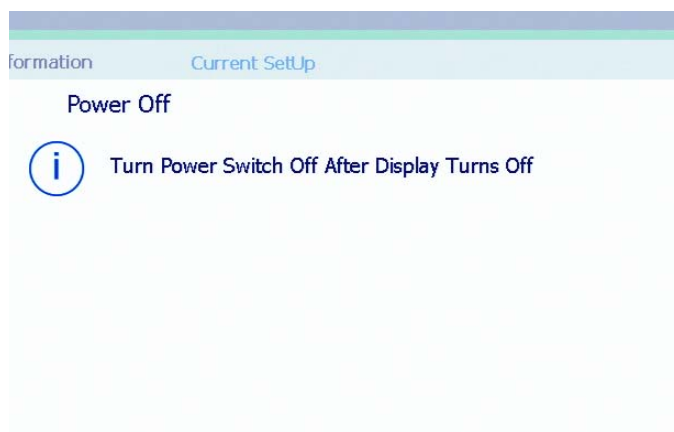

Figure 7-18 Power Off Confirmation

Section 8. Unit Maintenance



All service must be performed by trained personnel only.

A mass spectrometer leak detector requires periodic maintenance to ensure continued reliable operation. After prolonged use, the leak detector accumulates contaminants from even the cleanest of products tested that eventually impair operation. A thorough disassembly and cleaning of the entire vacuum system, which includes the valve block and spectrometer, restores normal operation. For heavy production use, more frequent overhauls may be needed. In most cases, maintenance personnel do this work, but Agilent can also do this work under the terms of a service contract.

This maintenance section covers daily and as-required maintenance. It does not cover overhaul of the entire vacuum system. If your leak detector requires service that is not covered in this section, contact Agilent Customer Service. See the back cover of this manual for a listing of our sales and service offices.

Important Reminders

In addition to the safety notes at the beginning of this manual, heed the following notes, cautions, and warnings when performing maintenance.



Disconnect power from the leak detector before performing any maintenance procedure that requires physically disconnecting any part of the system.

The leak detector has two battery backed clocks which use a primary (non-rechargeable) lithium coin battery from Panasonic, P/N BR2477A/HB (3.0V, 1Ah) that is permanently soldered onto a Motherboard PCB and Panasonic's P/N BR2032 (3.0V, 500 mAh) located on the CPU PCB.. Never replace this battery with a rechargeable type. Use only the primary type of lithium battery. Only a qualified technician should replace any battery. The battery has a life of 7 to 10 years.

The leak detector uses fuses and circuit breakers that are not operator replaceable. Only a qualified technician should replace any fuse.

Information about the fuses and circuit breakers is given in Table 8-3 on page 134.

Agilent Technologies Helium Leak Detector

Cleanliness is vital when servicing the leak detector or any vacuum equipment. There are some techniques more important in leak detector servicing than in general vacuum work:

CAUTION



Do not use silicone oil or silicone grease.

Use powder-free butyl or polycarbonate gloves to prevent skin oils from getting on vacuum surfaces.

Do not clean any aluminum parts with Alconox®. Alconox is not compatible with aluminum and will cause damage.

NOTE



Agilent does not recommend the use of vacuum grease.

Vacuum grease absorbs helium tracer gas and releases this slowly resulting in helium background during leak test operations. If it must be used, use it sparingly and avoid silicone types. Apiezon® L grease is recommended (Agilent Part No. 695400004).

When removing, checking or replacing O-rings:

CAUTION



Remove O-rings carefully with your fingers. Do not use metal tools for this task. This prevents scratching of any sealing surfaces.

Wipe all O-rings clean with a lint-free cloth before installation to ensure that no foreign matter is present to impair the seal.

Do not use grease or any other substances on O-rings or metal seals that will come in contact with the spectrometer.

Do not use alcohol, methanol or other solvents on O-rings as this causes deterioration and reduces their ability to hold a vacuum.

NOTE



If applicable, apply a small amount of Apiezon® L grease and wipe the O-rings shiny dry.

NOTE



Due to the effective cleaning nature of VacuSolv solvent and its residue-free properties, Agilent' Component and Spectrometer Cleaning Kit (Part Number 670029096), used in accordance with the kit instructions, is recommended for cleaning spectrometer components. The kit can also be used for fine cleaning of other parts in the leak detector's vacuum system such as valves and fittings. No rinsing steps or high-temperature drying are required following cleaning with VacuSolv. Although appropriate precautions are advised, VacuSolv is compatible with most materials and does not contain toxic chemicals or CFCs (chlorofluorocarbons). Other acceptable solvents are isopropyl alcohol (IPA) or Dow Corning® OS-20.

Agilent Technologies Helium Leak Detector

For simplicity, the maintenance functions in this section are grouped by recommended frequency, as shown in Table 8-1, based on assumed daily use.

Table 8-1 Scheduled Maintenance

Description	Daily	12 Months	24 Months
Calibration check	X		
Replace the internal calibrated leak		X	
Replace diaphragm on DP pump (Dry scroll pump models only)		X	
Replace tip seals on models: G8610B, G8611B, G8611C, G8611D, G8612B, G8611C			X
Change Oil - Models G8610A, G8611A, G8611B, G8611D, G8612A		X	

Maintenance functions that may be required on a demand basis, such as changing a filament after filament failure, are listed in Table 8-2.

Table 8-2 As-Required Maintenance

Function	Most Common Symptom
Spectrometer cleaning	The spectrometer is designed to operate for years without maintenance, however actual performance depends on the leak detector operational environment. Spectrometer cleaning restores optimum performance if the unit shows significant sensitivity loss or high background signal. Sensitivity loss appears as a high gain value after a calibration or failure to calibrate with a <i>gain too high</i> error message.
Filament replacement	Filaments are designed to operate for several years with no maintenance. When a filament burns out, the system automatically switches to the other filament and notifies you to recalibrate. The calibration notice also serves to inform you of a filament failure. Agilent recommends that the burned out filament be replaced at a convenient time so that a spare is always available during leak test operations to prevent unplanned system down time.

Agilent Technologies Helium Leak Detector

Table 8-2 As-Required Maintenance

Function	Most Common Symptom
Tuning adjustments	If calibration is not successful or if the system is calibrated to an external leak, tuning can maximize the helium signal.
Mechanical pump fluid change	Persistent, high helium background signal. Fluid contamination (dirty brown color indicates burnt or contaminated fluid, milky white consistency indicates high water vapor content in fluid).



Always perform a Full Internal Calibration after any spectrometer maintenance:

- Spectrometer header replacement*
- Filament replacement*
- Ion source assembly replacement or cleaning*

Table 8-3 lists the fuses and circuit breakers.

Table 8-3 Fuses and Circuit Breakers

Function	Type, MFG, PIN	Location
Circuit Breaker	<input type="checkbox"/> Main Power Supply: 20 A, 250 V AC, SCHURTER Model EF12, PIN EF12.2196.1110.01	Power Entry Module
	<input type="checkbox"/> Internal Vacuum Pump: 6 A, 250 V E-T-A, PIN 1110-FI12-PIMI-6 A	Rear Panel
Fuses (PCB overcurrent protection)	1.85 A, 33 VDC, Raychem SMD185-2	<input type="checkbox"/> Motherboard (RT400) <input type="checkbox"/> Valve Driver (FI) <input type="checkbox"/> Ion Source (FI)
	5x20mm, T4A, 5A, 250V AC, Cooper/Bussmann S505-4A	Turbo Controller (F2)



Only a qualified technician should replace circuit breakers and fuses. Use only circuit breakers and fuses of the same type and rating.

8.1 Daily Maintenance

8.1.1 Sensitivity Check

To perform a sensitivity check:

1. Turn on the Std Leak in the Control Panel screen.
2. Compare the value on the Home screen to the value of the known calibrated leak on the Internal Calibrated Leak screen.
3. If the values do not match, press **Calibrate** on the Control Panel screen to perform an automated calibration and then repeat step 1.

If specification is still not met, Manual Tuning may be required. See Section 7.4.3 “Manual Tuning” on page 118.

8.2 Dry Nitrogen Vent

You may want to vent the leak detector test port with dry nitrogen when the system is vented. Venting with dry nitrogen can be helpful in very humid environments to keep the test port as dry as possible which reduces the time required to pump down the system.



The nitrogen supply line should have a pressure relief valve installed so that the pressure does not exceed two psi.

1. Press down on top of fitting and remove filter (Figure 8-1).
2. Install 6mm tubing for Dry Nitrogen venting.



Figure 8-1 Dry Nitrogen Vent

8.3 Spare Parts List

Table 8-4 Leak Detector Spare Parts

Assembly	Part Number
Motherboard PCB	R2101501
Ion Source PCB	R2120502
Valve Driver PCB	R2104502
Exchange Turbo Pump Controller PCB	EX9699518M001
Touchscreen Display	G8610-68003
Spectrometer Assembly, Exchange	G8610-69008
Ion Source Replacement Kit	VSFLDHIS
Filament Replacement Kit	VSFLDHFR
Metal Gasket Kit	VSFLDMG
Valve Block O-ring Kit	VSFLDOV
Calibrated Leak, Internal	VSFLDCL
TC Gauge	R3391301
Fan Assembly	VSFLDFN
Power Supply	VSFLDPS
Spec Tube Cleaning Kit	670029096
Fan, IDP3 Pump	VSFLDFN3
Back to Air, Maintenance Kit (V9)	VSFLDV9
Exhaust Valve, V8	VSFLDV8
Turbo Pump, Exchange	EX8699367
Valve (V1 to V5, V7)	R2010302
V6 Calibrated Leak Valve	G8603-60002

Agilent Technologies Helium Leak Detector

Table 8-5 Primary Pumps Replacement Parts

Description	Model Number	Part Number
DS302, Exchange Rotary Vane Pump	G8611A, G8612A	EX9499325
DS302 Minor Maintenance Kit	G8611A, G8612A	9499370
TriScroll 620, Exchange Module	G8611B, G8612B	X3828-69510
TriScroll 620, Exchange Pump for cart and bench models	G8611B, G8612B	X3828-69500
Oil Mist Eliminator (DS302 and DS602)	G8611, G8612	9499395
Oil Mist Eliminator (DS40M)	G8610A	X3703-64003
DS40M Maintenance Kit	G8610	X3703-64005
DS40M Rotary Vane Pump, 120 V	G8610A	X3703-64000
DS40M Rotary Vane Pump, 220 V	G8610A	X3703-64001
IDP-3 Exchange Scroll Pump 220 V	G8610B	EXIDP3A41
IDP-3 Exchange Scroll Pump 120 V	G8610B	EXIDP3B41
IDP-3 Exchange Scroll Pump 100 V	G8610B	EXIDP3C41
IDP-3 Tip Seal Kit	G8610B	IDP3TS
Diaphragm Pump Maintenance Kit	G8610B, G8611B, G8611B, G8612B, G8612C	VSFLDDP
Diaphragm Pump Replacement Kit	G8610B, G8611B, G8611B, G8612B, G8612C	VSFLDDPR
Elite Z Mechanical Pump Oil	G8611A, G8612A, G8610A, G8611D	695409005
IDP-15 Scroll Pump Exchange	G8611C, G8612C	X3815-69010
IDP-15 Tip Seal Kit	G8611C, G8612C	X3815-67000
DS602, Exchange Rotary Vane Pump	G8611D, G8612D	EX9499335
DS602 Minor Maintenance Kit	G8611D, G8612D	9499371

8.4 Leak Detector Accessory Item List

Table 8-6 Leak Detector Accessory Item List*

Assembly	Part Number
Flapper Box, NW25 Flange	VSFLDFBNW25
Flapper Box, Cable (I/O option required)	VSFLDFBCBL
Power Probe, 10' (NW25 Flange)	K9565306
Power Probe, 25' (NW25 Flange)	K9565307
Spare Tip Filters for Power Probe (Qty: 10)	K9565303
Throttle Valve (NW25 Flange)	R1947301
Calibrated Leak, 10 ⁻⁵ , 10 ⁻⁶ (NW25 Flange)	F8473325
Calibrated Leak, 10 ⁻⁷ (NW25 Flange)	F8473321
Calibrated Leak, 10 ⁻⁸ (NW25 Flange)	F8473322
Calibrated Leak, 10 ⁻⁹ (NW25 Flange)	F8473323
Calibrated Leak, 10 ⁻¹⁰ (NW25 Flange)	F8473324
Oil Mist Eliminator (G8610A)	VSFLDME
1-1/8" Compression Test Port	VSFLDCP
I/O Assembly, Field Installed	VSFLDIO
Handheld Wireless Remote Unit	G8600-60002
Wireless Remote Base Unit, Field Installed	G8610-63000

*Most accessories with NW25 fittings are available with 1 1/8 compression fittings. Call technical support for more information.

Appendix A. Communications Protocol

This appendix defines the technical specifications for the RS-232 protocol used with the leak detector and describes the customer-configured inputs/outputs.

A.1 Protocol (RS-232)

RS-232 ports operate at 9600 baud, 8 bits, no parity, and one stop bit.

All characters transmitted to the leak detector are echoed by the leak detector. Commands, inquiries, and strings of both commands and inquiries must be terminated by a carriage return <CR>; the carriage return is echoed as a space character.

The maximum length of the input is 80 characters; if no carriage return has been received before the 80th character, execution of the command string begins anyway.

Words that begin with:

- ❑ **?** are inquiries for the controlling device to determine the current state or value of a leak detector parameter.
- ❑ **PUT-** are commands for the controlling device to set the current state or value of a volatile leak detector parameter.
- ❑ **INIT-** are commands for the controlling device to set non-volatile leak detector parameters.

Other commands do not require a parameter and do not begin with any special characters.

Successful inquiries respond with data, followed by a space, then: **ok**<CR><LF>, as specified in the tables of this appendix. Unsuccessful inquiries respond with the offending inquiry followed by a space, then: **#?**<CR><LF> (line feed, <LF>).

Inquiries, parameters, and commands can be concatenated. Each word or numeric parameter is followed by one or more spaces. The string is terminated by a <CR>, which causes execution to begin.

Successful strings respond with the specified data for the input inquiries in the order the inquiries were issued, followed by: **ok**<CR><LF>.

Unsuccessful strings respond with the *first* offending command followed by a space, then: **#?**<CR><LF>. All commands and inquiries following the failed word are ignored; all parameters are discarded.

Table A-1 on page 143, Table A-2 on page 146, Table A-3 on page 149, and Table A-4 on page 149 outline the available control and query commands.

A.2 Communicating with RS-232

The RS-232 Protocol is intended for diagnostic purposes and initial set-up inquiries. The RS-232 connection is located on the rear D-sub 9-pin connector.

The leak detector RS-232 port is not an interrupt-driven port. It is configured as DTE (Data Terminal Equipment), therefore the leak detector's RS-232 Protocol cannot be sent as strings.



When programming with virtual instrumentation programs such as LabView, TestPoint, or Visual Basic, try one the following two methods:

- Transmit the intended command one character at a time with a minimal delay time of 50 milliseconds between each character. Terminate the command with a carriage return (CR).
- Transmit the intended command one character at a time. Wait for an echoed response from the leak detector before transmitting the next character. Terminate the command with a carriage return (CR)

Windows 95 and later versions contain a serial communications program called HyperTerminal, a useful tool in establishing communication between the leak detector and a PC.

A.2.1 Windows HyperTerminal Set-Up Instructions

To set up Windows HyperTerminal:

1. Click **Start**.
2. Select *Programs > Accessories > Communications > HyperTerminal*.
3. Double-click **Hypertrm.exe**.
The Connection Description dialog box appears.
4. Enter a name and choose an icon for the connection, for example: leak detector RS-232.
5. Click **OK**.
The Connect To dialog box appears.
6. Select a COM port from the *Connect Using:* the pull-down list.
The Com Properties/Port Setting dialog box appears.

7. Configure the following settings:
 - Bits per second (baud rate) – **9600**
 - Data bits: – **8**
 - Parity: – **None**
 - Stop bits: – **1**
 - Flow Control: – **None**
8. Click **OK**.
9. Select **Properties** from the File menu.

The Properties window appears.
10. Configure the following settings on the Connect To tab:
 - Connect using – Verify the COM port is correct.
 - Click **Configure** and verify the port settings are correct.
11. Ensure that the Settings tab is configured as follows:
 - Terminal keys radio button selected.
 - Ctrl+H radio button selected.
 - Auto detect selected from the Emulation pull-down list.
 - ANSI entered in the Telnet terminal ID.
 - 500 set in the Background buffer lines field.
12. Click **ASCII Set-Up**.

The ASCII Set-Up dialog box appears.
13. Ensure that the settings are as follows:
 - Line delay – **0 milliseconds**
 - Character delay – **0 milliseconds**
 - ASCII Receiving – **Wrap lines that exceed terminal width**

The cursor begins blinking.
14. Type some simple commands:
 - ?LEAK
 - ?ALL
 - ?SETUP

A.2.2 Printing with HyperTerminal

The easiest way to print information captured in HyperTerminal is to choose Print from the File menu; however, this method only prints information currently displayed on the screen. Screen information can also be highlighted, copied and pasted into Microsoft Word or Excel.

To capture large amounts of data that exceeds the terminal screen limits, use the Transfer menu Capture Text option:

1. Select *Transfer > Capture text*.
The Capture text dialog box appears.
2. Click **Browse**.
The Select Capture File dialog box appears.
3. Navigate to a location, enter a file name and select a file type:
 - .txt text file (Notepad)
 - .doc (Word)
 - .xls (Excel)
4. Click **Save**.
The Capture Text dialog box reappears.
5. Click **Start** to log data.
6. Select *Transfer > Capture Text > Stop* to end text capture.
7. Open the file where the data was stored and select *File > Print*.

Example

To use the above procedures to poll the leak detector leak rate using HyperTerminal and capture the text:

1. Type the command: **XYZZY**.
If received correctly, the leak detector responds *ok*.
2. Type the command: **?LEAK 1 SECS CR ?ESC**.
This command polls the leak rate every second. The time is set in seconds.
3. Press **ESC** to abort polling.
4. Select *Transfer > Capture Text*.
5. Browse to a folder and file using the Capture Text dialog box and click **Start**.
6. Select *Transfer > Capture Text > Stop* to abort data logging.

Agilent Technologies Helium Leak Detector

Table A-1 lists inquiries that are used to determine internal operating parameters. All inquiries, except VER, begin with ? and end with <CR>.

Table A-1 Internal Operating Parameters

Inquiry	Response
?ALL	Responds with four lines. Each begins with a <cr><lf>. The first line reports the ion chamber value. The second line reports the emission value. The third line reports the value of the offset variable. The fourth line reports the gain value.
?AZ<0	Reports the status of the Auto-zero < 0 function, ON or OFF.
?CALOK	Reports the status of the last calibration.
?CL-XFER	Reports the currently stored contra-flow mode crossover pressure.
?CPLOCKOUT	Reports the status of the control panel lockout feature, ON or OFF.
?CURRDATE	Reports the current system date and time in the following format: 3 05/25/2005 04:19:03.35 1 where 3 is the day of the week (0 = Sunday, 1 = Monday, etc), 05/25/2005 is mm/dd/yyyy (date), 04:19:03.35 is hh/mm/ss/ms (time) and 1 is PM (0=AM, 1=PM, 2=24 hour).
?DISPLAY	Reports what the display bar graph is set to, <i>log</i> or <i>lin</i> .
?EMISSION	Reports the emission value.
?EXPONENT	Reports the current manual-mode exponent with a two-character (minus followed by one digit) number. The exponent is within the least sensitive range (as reported by ?RANGE) and the three lower (more negative exponent) ranges. See also INIT-EXPONENT.
?EXTLEAK	Reports the currently stored value of the external standard leak.
?GAIN	Reports the system gain value by returning a three-character number consisting of a two-digit gain factor with a decimal point after the first digit.
?INTEXT	Indicates which leak, Internal or External has been selected for use during calibration.
?IOBOARD	Returns the status: 0 = not installed, 1 = installed
?IO_VER	Returns the software revision of the installed I/O PCB
?IONCHAMBER	Reports the ion chamber value.
?LANGUAGE	Reports the language that has been selected to display on the front panel (0=English, 1=French, 2=German, 3=Korean, 4=Spanish, 5=Japanese, 6=Chinese or Russian depending on software version purchased).

Agilent Technologies Helium Leak Detector

Table A-1 Internal Operating Parameters (Continued)

Inquiry	Response
?LEAK	Reports a six-character number consisting of a two-digit leak rate mantissa with decimal point after the first digit followed by E - then a two digit number, which is the leak rate range exponent (e.g., 1.3E-08).
?LKEXPIRE	Reports the internal calibrated leak expiration date mm/dd/yyyy.
?LEAKTEMP	Reports the internal calibrated leak temperature that the factory calibration was performed at (degrees C).
?LP	Reports the current leak rate along with the test port and system pressures.
?LPV	Reports the current Leak Rate, Pressures and Valve state.
?ML-XFER	Reports the current contra to midstage crossover pressure setpoint in Torr. The response is in exponential format (in Torr): X.XE-XX
?PREHEAT	Command to query if the preheat ion source PCB is installed A response of 0 = No, 1 = Yes
?PREHEAT-TIME	A numerical response in minutes.
?PRESSURES	Reports two lines. Each begins with a <cr><lf>. The first line consists of the words <i>test port TC</i> followed by a number in mTorr. The second line consists of the words <i>system TC</i> followed by a number in uTorr.
?PWDLEVEL	Response will be a number (1, 2 or 3).
?PWDONOFF	Reports status of system password (ON or OFF).
?QUICK-CAL	Reports whether Fast or Full Calibration is chosen if a calibration were to be started.
?RANGESTOP	Reports the value of the Range Stop variable.
?REJECT	Reports the reject leak rate setpoint (e.g., 7.0E-05) (where x is a number from 1 to 4 or the letter A).
?>xREJECT	Reports the status of a reject set point (where x is a number from 1 to 4 or the letter A).
?xREJECT	Reports the reject leak rate setpoint (e.g., 7.0E-05) (where x is a number from 1 to 4 or the letter A).
?ROUGH	Reports the currently stored Test Sequencer rough time used as part of setting up the Auto Sequencer.
?RSONOFF	Reports the status of the Rangestop function as Enabled or Disabled.
?SEQONOFF	Reports the status of the Auto Sequencer as Enabled or Disabled.

Agilent Technologies Helium Leak Detector

Table A-1 Internal Operating Parameters (Continued)

Inquiry	Response
?SETUP	Reports seven lines, each begins with a <cr><lf>. The first line reports the turbo pump speed with the RPM value or OFF. The second line reports the selected manual leak rate range, and the ranging method as auto or manual. The third line reports the least sensitive leak rate range. The fourth line reports the reject set point leak rate. The fifth line reports the internal calibrated leak rate value. The sixth line reports the DAC output method as Linear, Log(2V), or Log(3V). The seventh line reports the active filament status as <i>One</i> or <i>Two</i> , followed by <i>Lit</i> or <i>Out</i> .
?SPLITFLOW	Returns the status of the split flow function, ON or OFF.
?STDLEAK	Reports a six-character number consisting of a two-digit calibration standard leak rate mantissa with a decimal point after the first digit followed by <i>E-</i> , and then by a two-digit exponent (e.g., 1.3E-07). This inquiry is used for reporting the calibration standard leak rate entered using INIT-STDLEAK.
?SYSLEAK	Reports the leak rate value that has been stored that relates to the split flow functionality.
?SYSPWD	Reports the value of the system password.
?TEST	Reports the currently stored Test Sequencer test time used as part of setting up the Auto Sequencer.
?TEMPFACTOR	Reports the internal calibrated leak temperature factor that is used as part of the temperature correction logic (degrees C).
?TURBO	Reports four lines, each begins with a <cr><lf>. The first line consists of the word <i>turbo</i> followed by either READY or NOT READY. The second line consists of the word <i>turbo</i> followed by <i>either Fault or No Fault</i> . The third line consists of the words <i>turbo speed RPM</i> followed by the RPM value: xxxxx. The fourth line consists of the words "Turbo Temp (Celsius):" followed by the bearing temperature value: XX.
?VALVESTATE	Reports the current mode of the valves: Vent, Hold, etc.
VER	Reports the CPU software version in the form LC02.05 followed by a six digit hexadecimal checksum.
?VOLUMEONOFF	Reports audio as either ON or OFF.
WHYNOCAL	Reports the calibration failure diagnostics.
?0ENABLE	Responds with the status of the <i>Zero Enable</i> function, ON or OFF.

Agilent Technologies Helium Leak Detector

The commands listed in Table A-2 are used to set *non-volatile* operating parameters. The current value of the operating parameter is changed to the new value. If the leak detector is in back panel control, the response is *cant*.

Table A-2 Non-Volatile Operating Parameters

Command	Parameter
INIT-AZ<0	Preceded by 0 or 1, sets the status of Auto-zero < 0. 0 = off, 1 = on.
INIT-CL-XFER	Preceded by <i>X.XE-X</i> , sets the value of the contra-flow mode crossover pressure in Torr.
INIT-CPLOCKOUT	Sets the status of the control panel lockout. Preceded by (0) or (1), 0 = OFF, 1 = ON.
INIT-DATE	Sets the system date and time. Preceded by: dow, mm dd yyyy hh mm ss AmPm 24-12 mode, Where 2 is the day of the week (dow) (0 = Sunday, 1 = Monday, etc), mm/dd/yyyy (date), hh:mm:ss (time) AmPm (0=AM, 1=PM)24-12 mode (0 for 24 hr, 1 for 12 hr). Examples: 2 02 12 2005 04 16 33 1 0 INIT-DATE(Tuesday, February 12, 2005, 4:16:33 on a 24 hr clock)2 02 12 2005 04 16 33 1 1 INIT-DATE(Tuesday, February 12, 2005, 4:16:33 PM)?CURRDATE reports the stored value
INIT-DISPLAY	Sets the status of the bar graph display to either a log or linear display. Preceded by (1) Log or (0) Linear.
INIT-EMISSION	Sets the emission of the ion source. Preceded by a three-digit number (micro-amps), in the range 60 to 165.
INIT-EXPONENT	Sets the range that the leak detector will operate in when Manual Range is ON. Preceded by 0 to -11.
INIT-EXTLEAK	Sets the value of the external leak. Preceded by a two-digit leak rate mantissa with a decimal point after the first digit followed by <i>E-</i> , and then by a two-digit leak range exponent: the helium leak rate number in atm cc/sec of the calibration standard leak. Example: 3.2E-08 INIT-EXTLEAK
INIT-FILAMENT	Sets the operating filament in the ion source. Preceded by a single digit, either 1 or 2.
INIT-GAIN	Sets the value of the gain used for adjusting the helium signal to match a calibration standard leak. Preceded by a two-digit number with a decimal point after the first digit, in the range 1.0 to 6.0. Note: Changing Gain changes Zero by the same ratio.

Agilent Technologies Helium Leak Detector

Table A-2 Non-Volatile Operating Parameters (Continued)

Command	Parameter
INIT-ION	Sets the ion voltage of the ion source. Preceded by a three-digit number (volts) in the range 220 to 280.
INIT-LANGUAGE	Selects the language to be shown on the display. Preceded by 0-6 where (0=English, 1=French, 2=German, 3=Korean, 4=Spanish, 5=Japanese, 6=Chinese).
INIT-LINEAR	Sets the leak rate analog output voltage to Linear. Not preceded by a value.
INIT-LKEXPIRE	Sets the date on which the internal calibrated leak expires. Preceded by the date. Example: mm dd yyyy INIT-LKEXPIRE
INIT-LEAKTEMP	Sets the internal calibrated leak temperature (printed on the leak label) that the factory calibration was performed at. Preceded by 12.0 to 50.0 (degrees C). Example: 23.5 INIT-LEAKTEMP
INIT-1LOG	Sets the leak rate analog output voltage to logarithmic at 1 volt per decade. Not preceded by a value.
INIT-ML-XFER	Sets the value of the midstage-flow mode crossover pressure in Torr. Preceded by X.XE-XX. The range is 1.0E-03 to 1.0E-01 Torr. The default is 1.0E-01 (100 mTorr).
INIT-PASSWORD	Sets the system password. Preceded by a 1 to 6 digit password and followed by a digit indicating the number of digits in the password. Example: 123123 6 INIT-PASSWORD. Password is read back using the ?SYSPWD command.
X INIT-PWDLEVEL	X is the password level from 1 to 3.
INIT-QUICK-CAL	Sets which type of calibration will be run if the CALIBRATE command is initiated. Preceded by 0 or 1, 0 for FULL cal, 1 for FAST cal.
INIT-RANGESTOP	Sets the value of the most sensitive range exponent. Preceded by XX.
INIT-1REJECT	Sets the leak rate value for Reject Set Point #1. Preceded by a two-digit leak rate mantissa with a decimal point after the first digit followed by E-, and then by a two-digit leak range exponent, the helium leak rate number is in atm cc/sec. Example 3.4E-08 INIT-1REJECT
INIT-2REJECT	Same as INIT-1REJECT, but for Reject Set Point #2.
INIT-3REJECT	Same as INIT-1REJECT, but for Reject Set Point #3.

Agilent Technologies Helium Leak Detector

Table A-2 Non-Volatile Operating Parameters (Continued)

Command	Parameter
INIT-4REJECT	Sets the test port pressure value for Reject Set Point #4. Preceded by a two-digit leak rate mantissa with a decimal point after the first digit followed by <i>E-</i> , and then by a two-digit exponent: the test port TC pressure in millitorr. Example 1.5E-02 INIT-4REJECT
INIT-AREJECT	Same as INIT-1REJECT, but for the Audio Reject Set Point.
HIGH-xREJECT	Sets the reject set point to activate when the actual test value is higher than the set point. Where x is a number from 1 to 4 or the letter A. For example, the reject set point is set for 7.0E-05 and the actual test value is 9.2E-05.
LOW-xREJECT	Sets the reject set point to activate when the actual test value is lower than the set point. Where x is a number from 1 to 4 or the letter A. For example, the reject set point is set for 7.0E-05 and the actual test value is 4.3E-07.
INIT-ROUGH	Sets the Auto Sequencer rough time in seconds. Preceded by <i>XX</i> .
INIT-SYSLEAK	Sets the split flow leak value, system must be in TEST and the split flow feature must be OFF when this parameter is set. Preceded by a two-digit leak rate mantissa with a decimal point after the first digit followed by <i>E-</i> , and then by a two-digit leak range exponent: the helium leak rate number in atm cc/sec. Example 3.4E-08 INIT-SYSLEAK.
INIT-STDLEAK	Sets the value of the internal leak. Preceded by a two-digit leak rate mantissa with a decimal point after the first digit followed by <i>E-</i> , and then by a two-digit leak range exponent: the helium leak rate number in atm cc/sec. Example: 3.2E-08 INIT-STDLEAK.
INIT-TCTPZERO	Used to calibrate the low-pressure end of the test port thermocouple to a known pressure higher than zero. Preceded by a number (<i>XX</i>) of mTorr representing the test port pressure at the time of the command.
INIT-TEMPFACTOR	Sets the temperature correction factor that is printed on the internal calibrated leak label. Preceded by -10 to +10. Example: -7 INIT-TEMPFACTOR
INIT-TEST	Sets the Auto Sequencer test time in seconds. Preceded by <i>XX</i> .
LOCK-MS	Enables the MS lock feature. If the system exceeds 150 mTorr, the system goes from Fine test directly into Roughing mode (no Contra mode). If the leak rate exceeds the 7 range, the over range symbol appears.

Agilent Technologies Helium Leak Detector

Table A-2 Non-Volatile Operating Parameters (Continued)

Command	Parameter
UNLOCK-MS	Disables the MS lock feature.
?MS-LOCK	Queries the status of the MS lock feature; either <i>on</i> or <i>off</i> appears.

The commands listed in Table A-3 are used to cause an immediate change in the spectrometer operating parameters. *These Commands Do Not Change The Non-Volatile Operating Parameters.*

Table A-3 Spectrometer Operating Parameters

Command	Parameter
PUT-EXPONENT	Sets the exponent leak range for Manual mode. Preceded by a two-character number. Acceptable values are 0 through -10.
PUT-ION	Sets the ion value of the ion source. Preceded by a three-digit number of volts, in the range 200 to 350.
PUT-RANGESTOP	Sets the Range Stop exponent. Preceded by two or three characters -XX or -X.

The commands listed in Table A-4 are used to cause certain leak detection actions.

Table A-4 Leak Detection Actions

Command	Action
AUTO	Initiates auto-ranging mode. Success is indicated by the normal <i>ok</i> response.
CALIBRATE	Initiates a Full or Fast calibration depending on system settings. The CPU software tunes, then adjusts the gain so that the current helium signal causes the current leak rate measurement to be the same as the most recently input using INIT-STDLEAK. If the gain is 2.9 or higher, a normal calibration is performed. Success is indicated by the normal <i>ok</i> response.
DECREMENT	Subtracts 1 from the Manual Ranging leak rate exponent (making it more negative). Success is indicated by the normal <i>ok</i> response. Does nothing in auto-ranging mode. Does nothing upon reaching the most sensitive range.
DISABLE-OENABLE	Turns the Zero Enable function OFF.
DISABLE-APP	Disables the active Applications Setup.
DISABLE-PASSWORD	Turns the password function OFF.

Agilent Technologies Helium Leak Detector

Table A-4 Leak Detection Actions (Continued)

Command	Action
DISABLE-xREJECT	Turns the Reject Set Point OFF. Where x is a number from 1 to 4 or the letter A.
DISABLE-RANGESTOP	Turns the Range Stop function OFF.
DISABLE-VOLUME	Turns audio OFF.
ENABLE-0ENABLE	Turns the Zero Enable function ON.
ENABLE-PASSWORD	Turns the Password feature ON.
ENABLE-xREJECT	Turns the Reject Set Point ON. Where x is a number from 1 to 4 or the letter A.
ENABLE-RANGESTOP	Turns the Range Stop function ON.
ENABLE-SEQUENCER	Turns the auto sequencer function ON.
ENABLE-SPLITFLOW	Turns the split flow function ON.
ENABLE-VOLUME	Turns audio ON.
EXTERNAL	Sets the External Calibrated Leak (in test port) as the leak for use during calibration.
INCREMENT	Adds 1 to the Manual Ranging leak rate exponent (making it less negative). Success is indicated by the normal <i>ok</i> response. Does nothing in auto-ranging mode. Does nothing upon reaching the least sensitive range.
INTERNAL	Sets the Internal Calibrated Leak as the leak to be used during calibration.
KEEP	Causes the leak detector to close most valves and enter the Hold state.
MANUAL	Turns the Manual Ranging Mode ON. Success is indicated by the normal <i>ok</i> response.
NOSNIFF	Turns the HIGH PRESSURE TEST function OFF.
ROUGH	Causes the leak detector to begin a roughing on the test port only.
SNIFF	Turns the HIGH PRESSURE TEST mode ON.
STDLEAK	Turns Read Std Leak ON/OFF. Verifies calibration by exposing internal cal leak to the system.
TPTCATM	Sets the current test port thermocouple reading to represent atmospheric pressure when the test port is exposed to atmosphere. Success is indicated by the normal <i>ok</i> response.
TPTCZERO	Sets the current test port thermocouple reading to represent a ZERO pressure reading when the test port pressure is less than 1.0E-04 Torr. Success is indicated by the normal <i>ok</i> response.

Agilent Technologies Helium Leak Detector

Table A-4 Leak Detection Actions (Continued)

Command	Action
TUNE	Adjusts the ion source voltage to cause a maximum response to helium.
VENT	Causes the leak detector to isolate and vent the test port to the atmosphere.
XYZZY	Unlocks the system so that all RS-232 commands are accessible.
ZERO	Sets the current leak rate measurement to be 0.0 atm cc/sec in the most sensitive range.

A.3 Customer Accessible Inputs and Outputs

A.3.1 Serial Connector

Use the *SERIAL* connector on the Rear Panel to interface the leak detector to a PC via an isolated RS-232 connection. Table A-5 and Figure A-1 provide details of the connection. A typical connection from a 9-pin PC serial connector requires a female-to-female, 9-pin, null modem cable, where pins 2 and 3 are crossed.

Table A-5 Serial Connector Summary

Pin	EIA Name	Description
2	Received Data	Data into the leak detector
3	Transmit Data	Data out of the leak detector
5	Signal Common	RS-232 Ground

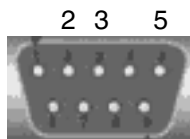

Figure A-1 Serial Connector Map

A.3.2 I/O Connector

Table A-6 lists the optional discrete I/O PCB (P/N# R2111501) pin signals. This I/O connector provides a means for a controller, usually a PLC, to control or to determine the leak detector status. The I/O is accessible via a type DB25S (female socket) connector.

Table A-6 I/O Connector Pin Signals

Pin No.	Signal Name	I/O	Signal	Description	Leak Detector Behavior
15, 19, 23	+ VIN	N/A	+5 V to +24 VDC	Customer-supplied +5VDC to + 24VDC for Output Common pins.	
17, 21	VRET	N/A	0 VDC	Customer -supplied GND for the Input Common pins.	
1	CAL_OUT	O	Level	Active HIGH when the leak detector is in CALIBRATION mode.	Performs calibrating routine with the Internal Calibrated Leak; Zeroing routine is included.

Agilent Technologies Helium Leak Detector

Table A-6 I/O Connector Pin Signals (Continued)

Pin No.	Signal Name	I/O	Signal	Description	Leak Detector Behavior
2	ZERO_OUT	O	Level	Active HIGH when the leak detector is in ZEROING mode.	Performs the Zeroing routine.
3	HOLD_OUT	O	Level	Active HIGH when the leak detector is in HOLD mode.	Performs a HOLD routine and isolates the test port and any test objects from the leak detector vacuum system.
4	VENT_OUT	O	Level	Active HIGH when the leak detector is in VENT mode.	Performs a VENT routine, isolates the test port from the leak detector vacuum system and vents the test port to atmosphere.
5	START_OUT	O	Level	Active HIGH when the leak detector is in START/ROUGH mode.	Performs a ROUGHING routine on the test port and any attached test objects.
6	READY_OUT	O	Level	Active HIGH when the leak detector is in READY mode.	Indicates that the leak detector is completing a STARTING routine and that the filament and turbo are OK.
7	TEST_OUT	O	Level	Active HIGH when the leak detector is in FINE TEST mode.	Indicates that the leak detector is ready for fine leak testing.
8	REJECT1_OUT	O	Level	Active HIGH when the leak rate is over set point #1.	Indicates that the value of the leak rate exceeds the value set in the 1REJECT variable.
9	REJECT2_OUT	O	Level	Active HIGH when the leak rate is over set point #2.	Indicates that the value of the leak rate exceeds the value set in the 2REJECT variable.
10	REJECT3_OUT	O	Level	Active HIGH when the leak rate is over set point #3.	Indicates that the value of the leak rate exceeds the value set in the 3REJECT variable.

Agilent Technologies Helium Leak Detector

Table A-6 I/O Connector Pin Signals (Continued)

Pin No.	Signal Name	I/O	Signal	Description	Leak Detector Behavior
11	REJECT4_OUT	O	Level	Active HIGH when the test port pressure is over set point #4.	Indicates that the value of the test port pressure exceeds the value set in the 4REJECT variable.
12	CAL_OUT_OK	O	Level	Active HIGH when calibration is successful.	Indicates the calibration has successfully completed. Set low on power-up or if calibration is not successfully completed.
13	AUTO_MANUAL_RANGE_IN	I	Level	Active HIGH when Manual Ranging is selected.	Activation causes the leak detector to change from AUTO to MANUAL ranging ; Default is AUTO.
14	CAL_IN	I	> 200 ms Pulse	Active HIGH pulse.	Initiate CALIBRATING routine with Internal Calibrated Leak; Zeroing routine is included.
16	ZERO_IN	I	> 200 ms Pulse	Active HIGH pulse.	Initiate ZEROING routine.
18	HOLD_IN	I	> 200 ms Pulse	Active HIGH pulse.	Initiate HOLD routine and isolate the test port and any test objects from leak detector vacuum system.
20	VENT_IN	I	> 200 ms Pulse	Active HIGH pulse.	Initiate VENT routine and vent the test port to atmosphere.
22	TEST_IN	I	> 200 ms Pulse	Active HIGH pulse.	Initiate ROUGHING routine on the test port and any attached test objects.

Agilent Technologies Helium Leak Detector

Table A-6 I/O Connector Pin Signals (Continued)

Pin No.	Signal Name	I/O	Signal	Description	Leak Detector Behavior
24	RDSTDLK_IN	I	Level	Active HIGH when standard leak is ON.	Initiate the INTERNAL STANDARD LEAK reading routine.
25	PARALLEL_ENABLE_IN	I	Level	Active HIGH when ENABLE is active.	Activation causes the leak detector to take inputs only from the rear panel I/O or RS-232 port. No control functions (inputs) from the front panel or wireless are allowed.

Figure A-2 shows the output circuit sketch. Level outputs are optically isolated emitter followers with 10 Ohm series resistors, and a 14 mA max drive current (24 VDC max).

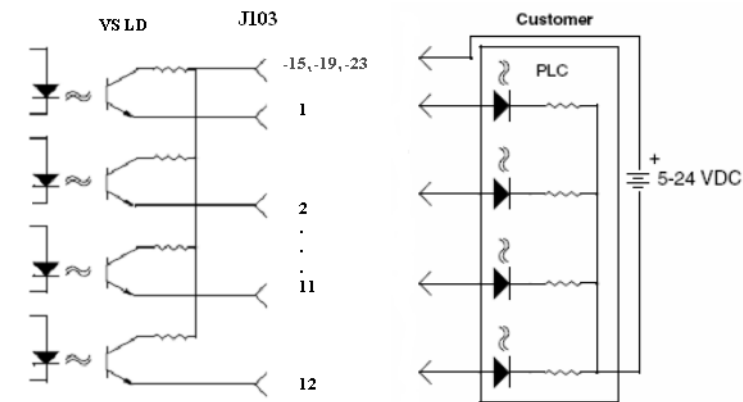

Figure A-2 Optically Isolated Output Circuit Sketch

Agilent Technologies Helium Leak Detector

Figure A-3 shows the input circuit sketch. All inputs are optically isolated 3300 Ohm resistive loads in series with the LEDs of the opto-isolators and voltage level from +5 VDC to +24 VDC. The required pulse inputs are 200 ms minimum pulse width.

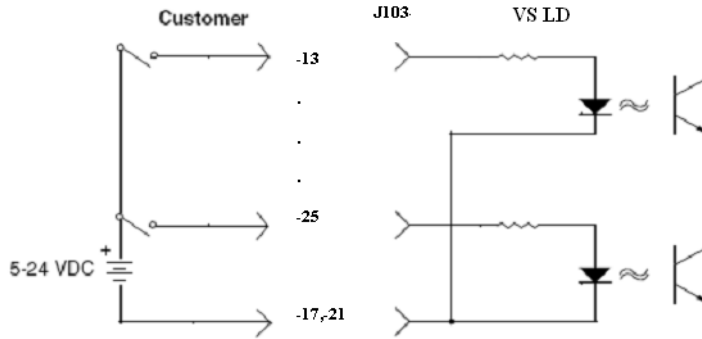

Figure A-3 Optically Isolated Input Circuit Sketch

Appendix B. Introduction to Leak Detection

B.1 Leak Testing—Why is it Needed?

Helium is a superior choice of tracer gas used to find leaks for a multitude of reasons. Helium is:

- Non-toxic
- Inert and non-condensable
- Normally not present in the atmosphere at more than trace amounts
- Relatively inexpensive
- Readily passes through leaks due to its small atomic size
- Non-flammable
- Available in various size cylinders
- Available in purities appropriate for medical usage

The only molecule smaller than Helium (mass 4) is Hydrogen (mass 2), which is not inert. Helium is much lighter than the next heavier inert molecule, Neon (mass 20) which is much more expensive. Helium is present at a concentration of only 5 ppm in normal atmospheric conditions.

B.2 Agilent's Helium Leak Detection Technologies

A Mass Spectrometer Leak Detector (*MSLD*) is a complete system for locating and/or measuring the size of leaks into or out of a device or a container. This method of leak detection is initiated when a tracer gas, helium, is introduced to a test part that is connected to the MSLD system. The helium leaking from the test part diffuses through the system, its partial pressure is measured, and results are displayed on a meter.

The MSLD operating principle consists of ionization of the gases in a vacuum and their acceleration across a voltage drop and a magnetic field (Figure B-1). The helium ions are separated and collected, and the resulting ion current is amplified and indicated on the meter or display.

A mass spectrometer leak detector consists of the following components:

- A spectrometer tuned to detect the mass of helium
- A vacuum system to maintain adequately low pressure in the spectrometer
- A mechanical pump(s) to evacuate the part to be tested

Agilent Technologies Helium Leak Detector

- ❑ Valves that enable the various stages of the leak detection cycle, from evacuation, to test, to venting
- ❑ Amplifier and readout instrumentation that monitors spectrometer output signal
- ❑ Electrical power supplies and controls that sequence valve's, protective circuits, etc.
- ❑ Fixturing that attaches the part to be leak-tested to the leak testing equipment

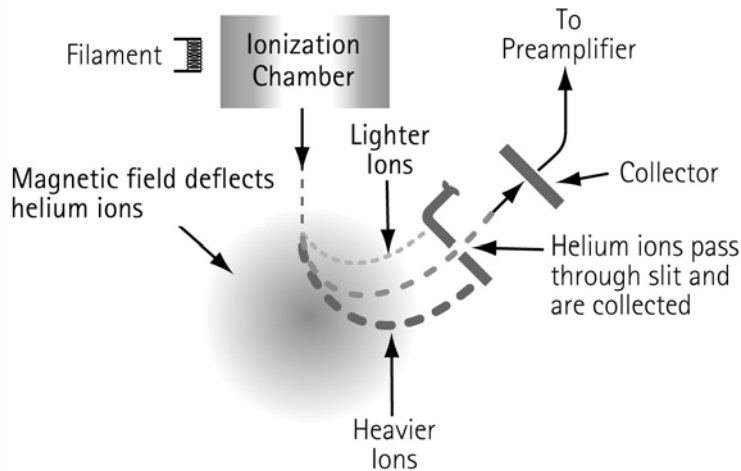

Figure B-1 Magnetic Separation Principle

Our *SIPD* family of products is also sensitive to helium and is based on a patented technology called Selective Ion Pump Detection (Figure B-2). The sensor technology incorporates an ion pump connected to a quartz capillary tube and maintained under high vacuum. This membrane is heated with a coiled platinum filament. Once heated, the membrane becomes permeable to helium. As the partial pressure of helium in the ion pump increases, so does the current draw of the ion pump. This current is proportional to the pressure and is therefore representative of the helium at the test probe of the instrument.

A selective ion pump detector consists of the following:

- ❑ An ion pump and controller
- ❑ A permeable quartz capillary
- ❑ A heater coil that surrounds the quartz capillary
- ❑ Electronics to process the signal
- ❑ Display for access to leak rate and other unit functions

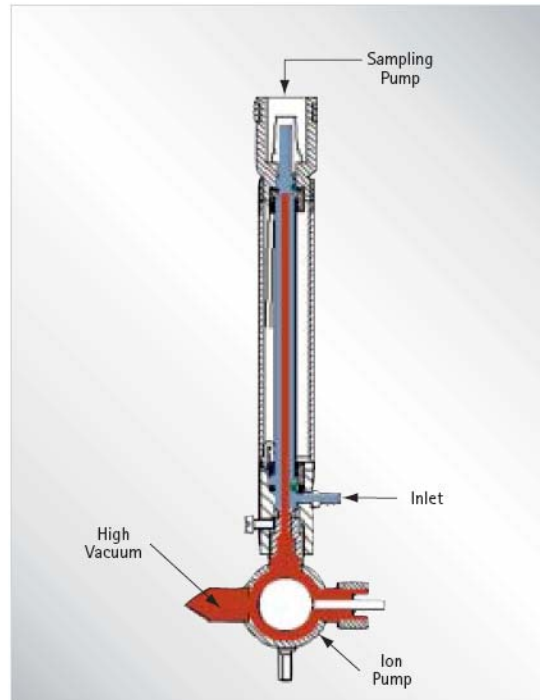

Figure B-2 Selective Ion Pump Detector

B.3 Methods of Leak Testing

There are many different ways to leak test parts using helium as a tracer gas. In general, the leak detection method is selected based on the actual working conditions of the part being tested. It is recommended that during leak testing, the same pressure differential be maintained and in the same *direction* as exists during the actual use of the part. For example, a vacuum system is tested with a vacuum inside the chamber, while a compressed air cylinder should be tested with a high pressure inside the cylinder.

There are two general concerns when leak testing. One is the location of leaks and the other is the measurement of the total leakage rate of the part, as some leakage may be acceptable. In many cases, parts may be first tested to determine if they pass an acceptable level, and if not, the part may be taken off line and subjected to a second test with the intent of locating the leak. Additionally, many parts may be tested in batches. If a batch fails, the individual parts in that batch may then be tested separately to identify the leaking part(s).

B.3.1 Vacuum Testing Method (Outside-in)

The part to be tested is evacuated with a separate pumping system for large volumes, or with just the leak detector itself. When the appropriate cross over pressure has been reached, the leak detector is valved-in or transfers into test and the part is tested using one of the following methods:

B.3.1.1 Locating Leaks

To pinpoint the location of the leak(s) (but not measure the total leakage rate), helium is administered to the suspected leak sites of the part using a spray probe with an adjustable flow (Figure B-3).

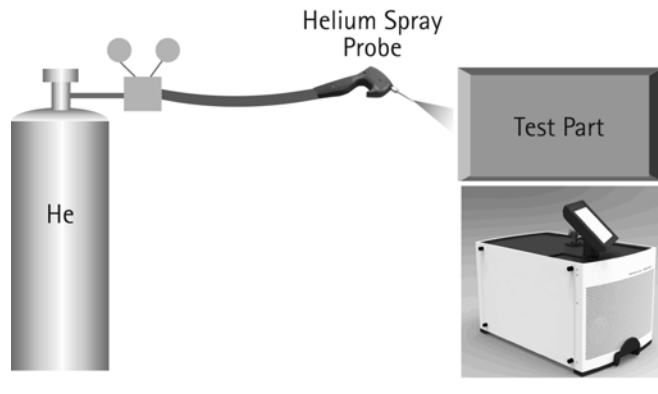

Figure B-3 Locating Leaks: Outside In

B.3.1.2 Measuring Leaks

To determine the total quantity of leakage (but not the number or location of leaks), the part is connected to the leak detector and shrouded by a helium environment. This helium environment can be contained in many methods ranging from a simple plastic bag to more complex bell jar arrangements (Figure B-4).

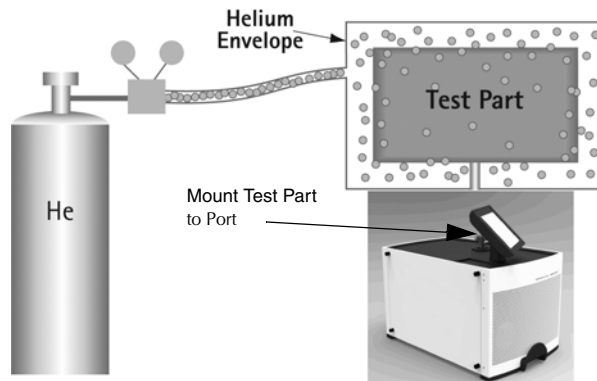

Figure B-4 Measuring Leaks: Outside In

B.3.2 Pressure Testing Method (Inside-out)

In this technique, the part is pressurized with helium or a mixture of helium and air, and tested by one of the following methods.

B.3.2.1 Measuring Leaks

To determine the total quantity of leakage (but not the number or location of leaks), the part is pressurized with helium (or a mixture of helium and air or nitrogen). This can be done by bombing or backfilling small hermetically sealed parts. Larger parts can be actively pressurized using a hose or tubing to deliver the helium. The part is placed in a volume that is then evacuated by the leak detector. All the helium escaping from the part is captured and quantified (Figure B-5).

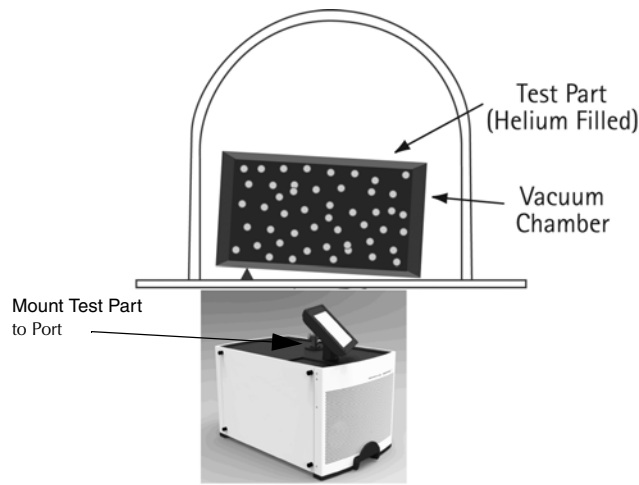

Figure B-5 Measuring Leaks: Inside Out

B.3.2.2 Locating Leaks

To pinpoint the location of the leak(s) (but not measure the total leakage), the likely potential leak sites of the part are scanned using a Sniffer Probe connected to the inlet of the leak detector (Figure B-6).

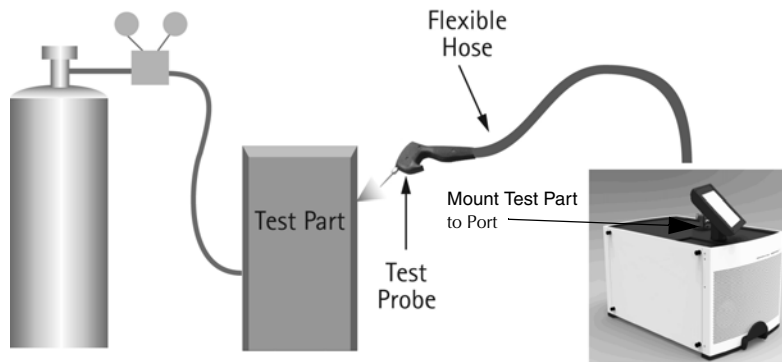

Figure B-6 Locating Leaks: Inside Out

B.3.2.2.1 Accumulation Testing Method

This method can both locate and quantify leaks. Some type of shroud or hood is placed in such a manner as to envelop a potential leak site. A certain amount of time is given to allow leaking helium to accumulate in the shrouded area, increasing the helium concentration. The leak detector is then valved-in to the shrouded volume. If many potential leak sites exist in a manifold or if many parts are to be tested at the same time, they can be sequentially valved-in to determine which site is leaking (Figure B-7).

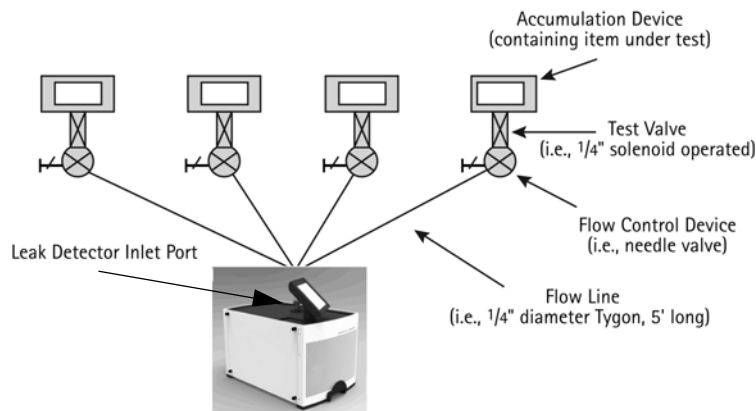

Figure B-7 Accumulation: Inside Out

B.3.3 System Leak Test Methods

Systems, like individual parts, should be tested with the same pressure differential and in the same direction as in actual use. Therefore, systems that are under vacuum while in operation should be leak tested under vacuum, while pressurized systems should be charged with helium to a pressure similar to operational conditions when possible.

B.3.3.1 Vacuum Systems

In general, vacuum systems are tested with a portable leak detector. Typically the leak detector is connected by means of a tee connected in between the foreline of the high vacuum pump and the inlet of its backing pump. A system should be capable of maintaining a foreline pressure low enough to operate the leak detector at this location. Helium is supplied to potential leak site using a spray probe or *bagging* suspected areas. If a leak exists, helium enters the system and rapidly diffuses through it. The leak detector should respond within several seconds or less. Leak detector sensitivity is diminished in systems with large backing pumps. If a system is using a cryopump as a high vacuum pump, it must be valved off before helium is introduced as cryopumps have limited helium pumping capacity (Figure B-8).

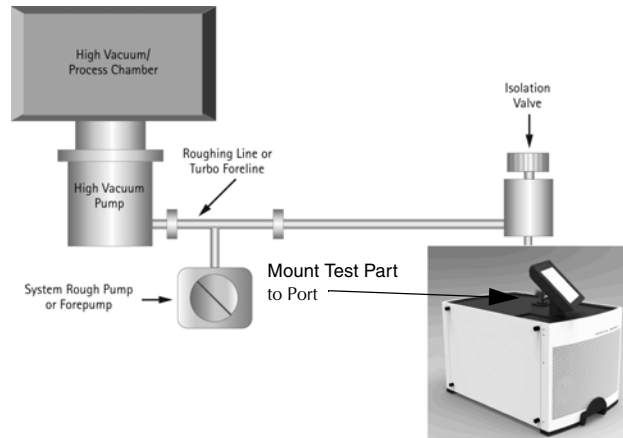

Figure B-8 Vacuum System

B.3.3.2 Pressurized Systems

Many different types of pressurized systems also need to be leak-free. These systems can be charged with helium or some mixture of helium and another gas such as nitrogen. If a diluted helium mixture is used, the helium signal is diminished proportionally. For example, if a mixture of 10% helium and 90% nitrogen is used, the signal reads 10% of the actual value of the leak, or a decade lower. This may be acceptable in many cases as system leak checking is usually to locate rather than quantify leaks. Once the system has been charged with an appropriate amount of helium, leak checking can be performed by means of a sniffer probe, or by *bagging* suspected leak sites so that leaking helium accumulates to a detectable level.

B.4 Typical Leak Detection Applications

B.4.1 Quality Control of Production Parts and Assemblies

The detection and location of leaks is critical in the production of many products from individual components, to subassemblies, to completed systems. In many of these cases, it is as important to know the size or rate of the leak, as it is the location. Whether quantitative or qualitative testing is required, our leak detectors help assure the leak integrity of your parts or assemblies. Some examples include:

Evacuated parts and assemblies

- Hermetically sealed electronic packages
- Valves and manifolding
- Feedthroughs/glass-to-metal seals
- Vacuum vessels and systems

Pressurized parts and assemblies

- Air conditioning and refrigeration assemblies
- Radiators, heat exchangers, and condensers
- Brake, fuel, and hydraulic lines
- Gas tanks
- Food storage tanks and packaging
- Body implantable medical devices
- High purity piping

B.4.2 Maintenance of Systems

Many vacuum process tools in fabs of all types require occasional leak checking. This may be part of a preventative maintenance schedule or in the event of an unexpected failure. Downtime in either case must be minimized. A rugged, dependable, fast starting leak detector is essential to maximize up time of production tools. Agilent Technologies Helium Mass Spectrometer portable leak detectors keep industry moving. Examples of some of these applications are:

Vacuum process equipment or tools

- Vacuum furnaces
- Vacuum coaters
- Beam lines
- Electron beam and ion beam process equipment
- Analytical Instruments

- Semiconductor process tools
- Laser process equipment

Pressurized systems

- Power Plants
- Underground tanks, cables, and pipes
- High purity gas handling systems
- Bioreactors and fermenters
- Liquid gas manufacturing facilities
- Fuel tanks and bladders

B.4.3 System Integrated Leak Detection

Manufacturers of large, complex systems may choose to integrate into those systems a component leak detector that can facilitate the on-going maintenance of leak-free integrity, thereby providing additional value to their customers. This unit provides the necessary elements for flexible integration of leak detection capability into a large system. Examples of these systems are:

- Semiconductor process equipment
- PVD/CVD equipment
- E-beam and ion beam processing equipment

B.4.4 Mass Produced Parts

Some manufacturing processes require the integration of a leak-checking device into a multi-step process, usually with very high production rates. Component leak detectors are designed specifically for these applications in which a vacuum system and the control electronics may be mounted separately. This unit offers the ultimate flexibility in a helium mass spectrometer leak detection system. The flexibility, ruggedness and rapid response time of these units allows for accurate, repeatable, high volume leak testing in demanding production environments. Some examples include:

High Volume Manufactured Parts

- Automotive fuel systems
- Automotive brake components
- Cooling and refrigeration system components
- Medical devices
- Automotive airbag components
- Tire and wheel assemblies

Portable Sniffing Applications

Some applications require operators or technicians to look for leaks from a ladder, outdoors, above or below ground, or in a densely constructed industrial facility or power plant. In these cases, a mobile cart-mounted MSLD may not be practical. A truly portable unit such as the PHD-4 is required. Some examples of such applications are:

- Aircraft manufacturing and maintenance
- Power generating plants
- Pressurized pipelines
- Bioreactors and fermenters
- Petrochemical plants and refineries
- Underground tanks
- Large condensers or heat exchangers

Appendix C. Specifications

C.1 Specifications

The specifications for the leak detector are provided in Table C-1.

Table C-1 Leak Detector Series Specifications

Specifications	Agilent Technologies Helium Mass Spectrometer Versions				
Pumps	Rotary Vane		Dry Scroll		
Fore Pump Type	DS40M	DS-302	TS-620	IDP-15	IDP-3
Pump Speed, l/min, 60/50 Hz	36/30	285/237	500/420	250/210	60/50
Minimum Detectable Leak, atm-cc/sec	5×10^{-12}				
Internal Pump Version	DS40M/IDP-3				
Turbo Molecular Pump	Navigator™ Turbo molecular pump specifically designed for leak detection				
Leak Units	atm-cc/sec, mbar-l/sec, torr-l/sec, Pa-m ³ /sec, std. ft ³ /year				
Peak Pumping Speed	<input type="checkbox"/> Contra w/ DS40M – 0.5 l/sec for N ₂ and He at 60Hz in Contra (.42 l/sec @ 50Hz). <input type="checkbox"/> Contra w/ DS302 – 3.0 liters/sec for N ₂ and He at 60Hz (2.5 l/sec @ 50 Hz). <input type="checkbox"/> Contra w/ TS620 – 6.0 liters/sec for N ₂ and He at 60Hz (5.0 l/sec @ 50 Hz). <input type="checkbox"/> Contra w/ IDP-3 - 1.1 l/sec (60 Hz), 1.0 l/sec (50 Hz) <input type="checkbox"/> Midstage – 1.8 liters/sec for He at 50 or 60 Hz.				
Helium Response Time	0.5 second, within 66% of peak reading within the given time. Per AVS 2.1.				
Test Port	NW-25; A 1 ¹ / ₈ " (28 mm) ID Compression Port is available as an accessory.				
Recommended Operating Ambient Conditions					
Installation	Indoor use only. Altitude up to 2000 m (6,400'), Material Group III, POLLUTION DEGREE 2 according to EN61010-1 Standard, Class 1				
Operating Temperature	System: +12° C to +45° C (wet and dry pumps); Fore pump limited on the low ends and turbo pump limited on the high ends.				
Humidity	Maximum relative humidity (HR) 90%				
Heat Load	1000 W (+/- 5%)				
Air Pressure	563 Torr (75 kPa) to 795 Torr (106 kPa)				
Maximum system vibration	3 G's (Turbo Limit)				

Agilent Technologies Helium Leak Detector

Table C-1 Leak Detector Series Specifications (Continued)

Specifications	Agilent Technologies Helium Mass Spectrometer Versions
Storage Ambient Conditions	Relative humidity: 0% to 95%, non-condensing. Temperature: -20 °C (-4 °F) to +60 °C (140 °F)
Power Requirements	Input Power <input type="checkbox"/> 100 VAC, 50 Hz, 20 A <input type="checkbox"/> 115 VAC, 60 Hz, 20 A or <input type="checkbox"/> 230 VAC, 50/60 Hz, 12 A Max. Branch Circuit Breaker: 20A with motor-rated time delay.
Dimensions	See outline drawings (Figure 1-1 on page 27 to Figure 1-14 on page 35).
Weight	G8610A with built in DS40M pump: 77 lb./35 kg* G8611A w/DS-302 rotary vane pump on cart: 172 lb./78 kg* G8611C w/IDP-15 dry scroll pump on cart: 194 lb./88 kg* G8611B w/TS-620 dry scroll pump on cart: 192 lb./87 kg* G8610B with IDP-3 dry pump: 77 lb./35kg* * Add 1.0 kg if the Wireless Remote and optional I/O features are installed.
Touch Panel display	8.4 inch color TFT LCD module G084SN03 V3. The screen format is intended to support the SVGA (800(H) x 600(V)) screen and 16.2M (RGB 8-bits) or 262k colors (RGB 6-bits). Viewing area 175.1 mm X 132.2 mm
Regulatory	CAN/CSA-C22.2 No. 61010-1-12 - Safety Requirements for Electrical Equipment for Measurement, Control, and Laboratory Use - Part 1: General Requirements UL Std. No. 61010-1, 3rd Edition - Safety Requirements for Electrical Equipment for Measurement, Control, and Laboratory Use - Part 1: General Requirements EMC Emissions and Immunity -ETSI EN 301 489-1 v2.2.0 (2017-03) Electromagnetic Compatibility and Radio Spectrum Matters (ERM); Electromagnetic Comparability (EMC) standard for radio equipment and services; Part1: Common technical requirements: <input type="checkbox"/> ETSI EN 301489 v2.2.1 (2012-09) Electromagnetic Compatibility and Radio Spectrum Matters (ERM); Electromagnetic Comparability (EMC) standard for radio equipment; Part 17: Broadband Data Transmission Systems <input type="checkbox"/> EN 61326-1: 2013 EMC requirements for Electrical equipment for measurement, control and laboratory use - General Use For particular Safety and EMC Standards see Declaration of Conformity.
Single rotation speed	Turbo: 70K RPM
Leak test range	E-11 to E-4
Maximum spectrometer pressure	1E-04 Torr - Filament turns off when pressure exceeds this point

Agilent Technologies Helium Leak Detector

Table C-1 Leak Detector Series Specifications (Continued)

Specifications	Agilent Technologies Helium Mass Spectrometer Versions
Contra cross over	10 Torr decreasing, 12 Torr increasing
Sensitivity in High Pressure Test mode	1×10^{-8} atm.cc.sec

This page intentionally left blank.



**Vacuum Products Division
Instructions for returning products**

Dear Customer:

Please follow these instructions whenever one of our products needs to be returned.

- 1) Complete the attached Request for Return form and send it to Agilent Technologies (see below), taking particular care to identify all products that have pumped or been exposed to any toxic or hazardous materials.
- 2) After evaluating the information, Agilent Technologies will provide you with a Return Authorization (RA) number via email or fax, as requested.
Note: Depending on the type of return, a Purchase Order may be required at the time the Request for Return is submitted. We will quote any necessary services (evaluation, repair, special cleaning, eg).
- 3) **Important steps for the shipment of returning product:**
 - Remove all accessories from the core product (e.g. inlet screens, vent valves).
 - Prior to shipment, drain any oils or other liquids, purge or flush all gasses, and wipe off any excess residue.
 - If ordering an Advance Exchange product, **please use the packaging from the Advance Exchange to return the defective product.**
 - Seal the product in a plastic bag, and package product carefully to avoid damage in transit. You are responsible for loss or damage in transit.
 - Agilent Technologies is not responsible for returning customer provided packaging or containers.
 - **Clearly label package with RA number.** Using the shipping label provided will ensure the proper address and RA number are on the package. Packages shipped to Agilent without a RA clearly written on the outside cannot be accepted and will be returned.
- 4) Return only products for which the RA was issued.
- 5) **Product being returned under a RA must be received within 15 business days.**
- 6) **Ship to the location specified on the printable label, which will be sent, along with the RA number, as soon as we have received all of the required information.** Customer is responsible for freight charges on returning product.
- 7) Return shipments must comply with all applicable **Shipping Regulations** (IATA, DOT, etc.) and carrier requirements.

RETURN THE COMPLETED **REQUEST FOR RETURN** FORM TO YOUR NEAREST LOCATION:

EUROPE:

Fax: 00 39 011 9979 330
Fax Free: 00 800 345 345 00
Toll Free: 00 800 234 234 00
vpt-customer@agilent.com

NORTH AMERICA:

Fax: 1 781 860 9252
Toll Free: 800 882 7426, Option 3
vpl-ra@agilent.com

PACIFIC RIM:

please visit our website for individual office information
<http://www.agilent.com>



Please read important policy information on Page 3 that applies to all returns.

1) CUSTOMER INFORMATION

Company Name:		Contact Name:	
Tel:	Email:	Fax:	
Customer Ship To:		Customer Bill To:	
Europe only: VAT reg. Number:		USA/Canada only: <input type="checkbox"/> Taxable <input type="checkbox"/> Non-taxable	

2) PRODUCT IDENTIFICATION

Product Description	Agilent P/N	Agilent S/N	Original Purchasing Reference

3) TYPE OF RETURN (Choose one from each row and supply Purchase Order if requesting a billable service)

- 3A. Non-Billable Billable **➔** New PO # (hard copy must be submitted with this form):
- 3B. Exchange Repair Upgrade Consignment/Demo Calibration Evaluation Return for Credit

4) HEALTH and SAFETY CERTIFICATION

AGILENT TECHNOLOGIES CANNOT ACCEPT ANY PRODUCTS CONTAMINATED WITH BIOLOGICAL OR EXPLOSIVE HAZARDS, RADIOACTIVE MATERIAL, OR MERCURY AT ITS FACILITY.

Call Agilent Technologies to discuss alternatives if this requirement presents a problem.

The equipment listed above (check one):

- HAS NOT** pumped or been exposed to any toxic or hazardous materials. OR
- HAS** pumped or been exposed to the following toxic or hazardous materials. If this box is checked, the following information must also be filled out. Check boxes for all materials to which product(s) pumped or was exposed:

- Toxic Corrosive Reactive Flammable Explosive Biological Radioactive

List all toxic/hazardous materials. Include product name, chemical name, and chemical symbol or formula:

NOTE: If a product is received at Agilent which is contaminated with a toxic or hazardous material that was not disclosed, **the customer will be held responsible** for all costs incurred to ensure the safe handling of the product, and **is liable** for any harm or injury to Agilent employees as well as to any third party occurring as a result of exposure to toxic or hazardous materials present in the product.

Print Name: _____ **Authorized Signature:** **Date:** _____

5) FAILURE INFORMATION:

Failure Mode (REQUIRED FIELD. See next page for suggestions of failure terms):
Detailed Description of Malfunction: (Please provide the error message)
Application (system and model):

I understand and agree to the terms of Section 6, Page 3/3.

Print Name: _____ **Authorized Signature:** **Date:** _____



**Vacuum Products Division
Request for Return Form
(Health and Safety Certification)**

Please use these Failure Mode to describe the concern about the product on Page 2.

TURBO PUMPS and TURBO CONTROLLERS

APPARENT DEFECT/MALFUNCTION	POSITION	PARAMETERS
- Does not start - Does not spin freely - Does not reach full speed - Mechanical Contact - Cooling defective	- Noise - Vibrations - Leak - Overtemperature - Clogging	- Vertical - Horizontal - Upside-down - Other: Power: Rotational Speed: Current: Inlet Pressure: Temp 1: Foreline Pressure: Temp 2: Purge flow: OPERATING TIME:

ION PUMPS/CONTROLLERS

- Bad feedthrough	- Poor vacuum
- Vacuum leak	- High voltage problem
- Error code on display	- Other

VALVES/COMPONENTS

- Main seal leak	- Bellows leak
- Solenoid failure	- Damaged flange
- Damaged sealing area	- Other

LEAK DETECTORS

- Cannot calibrate	- No zero/high background
- Vacuum system unstable	- Cannot reach test mode
- Failed to start	- Other

INSTRUMENTS

- Gauge tube not working	- Display problem
- Communication failure	- Degas not working
- Error code on display	- Other

SCROLL AND ROTARY VANE PUMPS

- Pump doesn't start	- Noisy pump (describe)
- Doesn't reach vacuum	- Over temperature
- Pump seized	- Other

DIFFUSION PUMPS

- Heater failure	- Electrical problem
- Doesn't reach vacuum	- Cooling coil damage
- Vacuum leak	- Other

Section 6) **ADDITIONAL TERMS**

Please read the terms and conditions below as they apply to all returns and are in addition to the Agilent Technologies Vacuum Product Division – Products and Services Terms of Sale.

- Customer is responsible for the freight charges for the returning product. Return shipments must comply with all applicable **Shipping Regulations** (IATA, DOT, etc.) and carrier requirements.
- Customers receiving an Advance Exchange product agree to return the defective, rebuildable part to Agilent Technologies **within 15 business days**. Failure to do so, or returning a non-rebuildable part (crashed), will result in an invoice for the non-returned/non-rebuildable part.
- Returns for credit toward the purchase of new or refurbished Products are subject to prior Agilent approval and may incur a restocking fee. Please reference the original purchase order number.
- Units returned for evaluation will be evaluated, and a quote for repair will be issued. If you choose to have the unit repaired, the cost of the evaluation will be deducted from the final repair pricing. A Purchase Order for the final repair price should be issued within 3 weeks of quotation date. Units without a Purchase Order for repair will be returned to the customer, and the evaluation fee will be invoiced.
- A Special Cleaning fee will apply to all exposed products per Section 4 of this document.
- If requesting a calibration service, units must be functionally capable of being calibrated.

This page intentionally left blank.

This page intentionally left blank.

Service & Support

North America

Agilent Technologies
Vacuum Products Division
121 Hartwell Avenue
Lexington, MA 02421 USA
Tel.: +1 781 861 7200
Toll-Free: +1 800 882 7426
Fax: +1 781 860 5437

Benelux

Agilent Technologies Netherlands B.V.
Vacuum Products Division
Herculesweg 8
4338 PL Middelburg
The Netherlands
Tel: +31 118 671570
Fax: +31 118 671569
Toll free: 00 800 234 234 00

Canada

Central coordination through
Agilent Technologies
Vacuum Products Division
121 Hartwell Avenue
Lexington, MA 02421 USA
Tel.: +1 781 861 7200
Toll-Free: +1 800 882 7426
Fax: +1 781 860 5437

China

Agilent Technologies (China) Co. Ltd
Vacuum Products Division
No.3, Wang Jing Bei Lu, Chao Yang
District
Beijing, 100102 China
Tel.: +86 (0)10 64397888
Fax: +86 (0)10 64391318
Toll-Free: 800 820 3278

France

Agilent Technologies France
Vacuum Products Division
3 avenue du Canada, Parc Technopolis
Z.A. Courtaboeuf - CS 90263
91978 Les Ulis cedex
France
Tel.: +33 (0)1 64 53 61 15
Fax: +33 (0)1 64 53 50 01
Toll free: 00 800 234 234 00
e-Mail: vpf.sales@agilent.com

Germany & Austria

Agilent Technologies
Sales & Services GmbH & Co. KG
Vacuum Products Division
Lyoner Str. 20
60 528 Frankfurt am Main
Germany
Tel.: +49 69 6773 43 2230
Fax: +49 69 6773 43 2250

India

Agilent Technologies India Pvt. Ltd.
Vacuum Products Division
G01. Prime corporate Park,
230/231, Sahar Road,
Opp. Blue Dart Centre,
Andheri (East), Mumbai – 400 099. India
Tel: +91 22 30648287/8200
Fax: +91 22 30648250
Toll Free: 1800 113037

Italy

Agilent Technologies Italia S.p.A.
Vacuum Products Division
Via F.lli Varian 54
10040 Leini, (Torino) ITALY
Tel.: +39 011 997 9111
Fax: +39 011 997 9350
Toll-Free: 00 800 234 234 00

Japan

Agilent Technologies Japan, Ltd.
Vacuum Products Division
8th Floor, Sumitomo Shibaura Building
4-16-36 Shibaura Minato-ku
Tokyo 108-0023 JAPAN
Tel.: +81 3 5232 1253
Toll-Free: 0120 655 040
Fax: +81 3 5232 1710

Korea

Agilent Technologies
Vacuum Products Division
Shinsa 2nd Bldg. 2F
966-5 Daechi-dong
Kangnam-gu, Seoul KOREA 135-280
Tel.: +82 (0)2 3452 2455
Toll-Free: 080 222 2452
Fax: +82 (0)2 3452 3947

Singapore

Agilent Technologies Singapore Pte. Ltd
Vacuum Products Division
Agilent Technologies Building,
No.1 Yishun Avenue 7
Singapore 768923
Tel: +65 6215 8045
Fax : +65 6754 0574

Southeast Asia

Agilent Technologies Sales Sdn Bhd
Vacuum Products Division
Unit 201, Level 2 uptown 2,
2 Jalan SS21/37, Damansara Uptown
47400 Petaling Jaya,
Selangor, Malaysia
Tel : +603 7712 6106
Fax: +603 6733 8121

Taiwan

Agilent Technologies Taiwan Limited
Vacuum Products Division (3F)
20 Kao-Shuang Rd.,
Pin-Chen City, 32450
Taoyuan Hsien, Taiwan, R.O.C.
Tel. +886 34959281
Toll Free: 0800 051 342

UK & Ireland

Agilent Technologies
Vacuum Products Division
6 Mead Road
Oxford Industrial Park
Yarnton, Oxford OX5 1QU UK
Tel.: +44 (0) 1865 291570
Fax: +44 (0) 1865 291571
Toll free: 00 800 234 234 00

Other Countries

Agilent Technologies Italia S.p.A.
Vacuum Products Division
Via F.lli Varian 54
10040 Leini, (Torino) ITALY
Tel.: +39 011 997 9111
Fax: +39 011 997 9350
Toll-Free: 00 800 234 234 00

Customer Service and Support

North America
Toll Free: 800 882 7426, Option 3
vpl-ra@agilent.com

Europe:
Toll Free: 00 800 234 234 00
vpt-customer@agilent.com

Pacific Rim:
Please visit our website for individual
office information <http://www.agilent.com>

Worldwide Web Site, Catalog and Order On-line:

www.agilent.com
Representatives in most countries



Agilent Technologies



This information is subject to change without notice.

© Agilent Technologies, Inc., 2017