



Nor-Cal Products



by PFEIFFER VACUUM



Nor-Cal Products

where technology takes shape

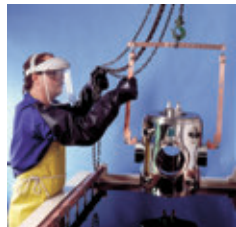
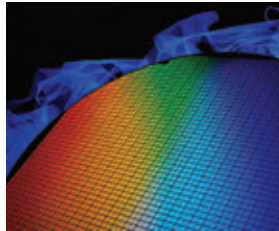
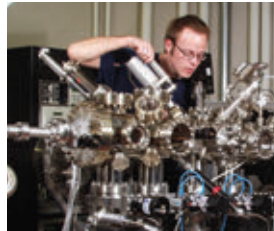

vacuum products catalog

Foreline Traps

Section Five

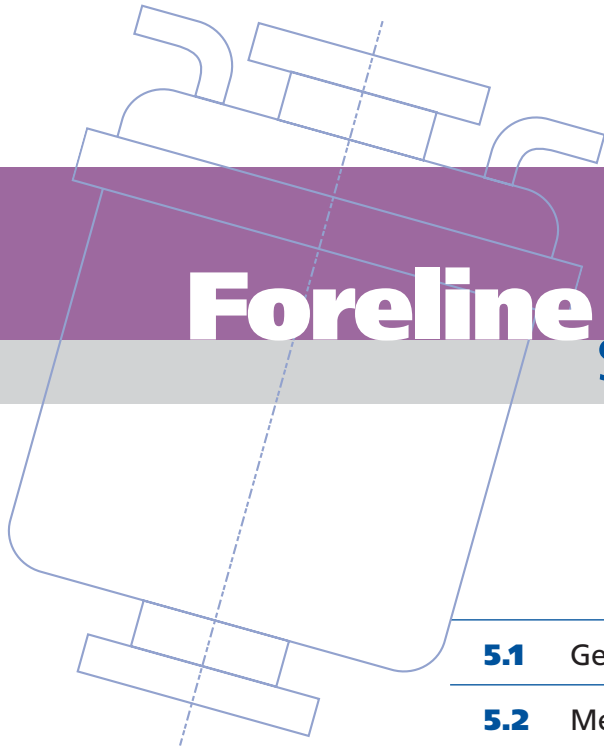
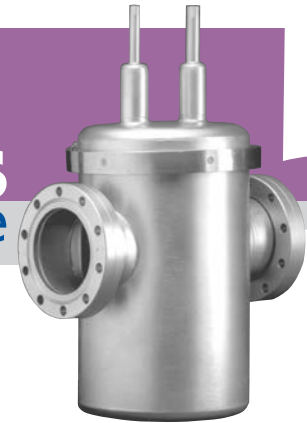

5.1	General Information	148
5.2	Metal Sieve Traps	150
5.3	Molecular Sieve Traps	152
5.4	Particulate Traps	153
5.5	LPCVD-TEOS Traps	154
5.6	Water-Cooled Traps	155
5.7	Liquid Nitrogen Traps	156
5.8	Oil Mist Eliminators	157
5.9	Filters, Hardware & Accessories	158



Nor-Cal Products, Inc.
 1967 South Oregon St.
 Yreka, CA 96097 USA
 Tel: **800-824-4166**
 or 530-842-4457
 Fax: 530-842-9130
www.n-c.com

Sales Office
 3375 Scott Blvd., Ste. 100
 Santa Clara, CA 95054, USA
 Tel: **408-980-8992**
 Fax: 408-980-8947

Nor-Cal Europe Ltd.
 Suite D, Dittons Engineering Park
 Dittons Road
 Polegate BN26 6HY
 United Kingdom
 Tel: **+44(0)1323 810854**
www.nor-cal.eu

Nor-Cal Korea
 Gadong 2nd Floor, 531-8 Gajang-ro
 Osan-si, Gyeonggi-do,
 South Korea, 18103
 Republic of Korea
 Tel: **+82(0)31-222-6086**
 Fax: +82(0)31-8003-1342

**Nor-Cal Products
 Asia Pacific Pte. Ltd.**
 Serangoon Garden
 P. O. Box 428
 Singapore 915531
 Tel: **+65 6634-1228**
 Fax: +65 6634-1008



Foreline Traps

General Information



Custom water and metal sieve multistage trap



Electropolish finish is available on all traps

Since 1962, Nor-Cal Products has been designing and building standard and custom foreline traps for the vacuum industry. These traps range in complexity from the sealed coaxial traps, which prevent oil backstreaming, to the triple-pass water cooled traps, which remove condensable gasses that contaminate mechanical pump oil or other parts of the system. Often times our customers see a 200% increase in preventative maintenance intervals after installing one of these traps.

All traps disassemble easily with a FKM O-ring and V-clamp, with the exception of our sealed coaxial metal sieve traps which have a one piece body. The two piece body allows for easy removal for cleaning or filter replacement.

The standard trap body finish is beadblast. Electropolish inside and out is available upon request. Electropolished traps are easier to clean because the surface is more highly polished than the standard beadblast finish. Nickelplating is also available for additional corrosion resistance.



TIG Fusion Welding

Trap Selection Guide

TRAP TYPE	METAL SIEVE		MOLECULAR	COLD		PARTICULATE	
	STAINLESS STEEL	COPPER	ZEOLITE	LN ²	H ² O	POLYESTER	FIBERGLASS
FILTER MATERIAL							
OIL BACKSTREAM	••	••	••	•••			
WATER VAPOR			••	•••			
ORGANICS				••	•		
ACID VAPORS				••			
PARTICLES <149°C	•	•				•••	•••
PARTICLES <370°C	•	•					•••
CONDENSIBLES - LOW VAPOR PRESSURE	••	••		•••	•••		
CONDENSIBLES - HIGH VAPOR PRESSURE	•	•		•••	•		

Blank - Trap is not appropriate for this application • - Good performance for this application
 •• - Better performance for this application ••• - Best performance for this application

Semiconductor Process Temperature Guide

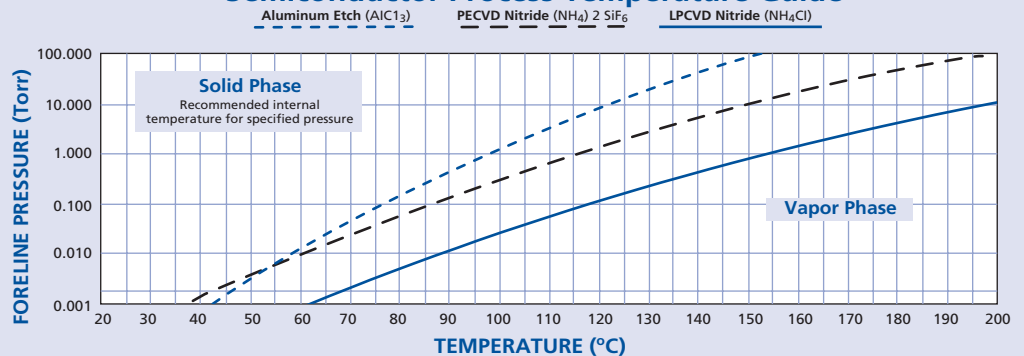

All dimensions are in inches (mm) & weights are in pounds (kg), unless otherwise noted.



LPCVD/TEOS trap and a heated foreline

Comprehensive Downstream Solutions

Our experience coupled with a broad product offering allows us to integrate components, providing comprehensive solutions to semiconductor fabs and equipment manufacturers.

A thorough system evaluation can improve overall performance and achieve customer defined goals. Download and complete our detailed cost-of ownership worksheet at www.n-c.com/downstreamsolutions before calling your Nor-Cal Products representative for assistance in calculating your cost of ownership model. A cost of ownership model can show payback as a result of increased tool utilization and decreased planned and unplanned maintenance costs.

Foreline traps, thermal products, Intellisys pressure control valves, Genesis soft start valves and weldments can be provided as turnkey modules. Thermal and vacuum characterization can be performed at Nor-Cal before the assembly is supplied, leak checked, blanked off and clean room packaged.

Custom Foreline Traps

Standard trap designs are readily altered or custom models are designed and fabricated to improve performance for your specific application. Some examples are described below. Call for more information or to discuss your specific application requirements and challenges..

Liquid Recovery Traps

Nor-Cal has provided many types of condensation traps for liquid collection before they enter the pump. Often they have valves or drains to allow the liquid to be collected and reused. Some of the liquids collected include photoresist, oil and tantalum.

High Capacity Particulate Traps

Nor-Cal can provide high-capacity particle traps with multi-liter capacities for applications with large particle loads, such as silicon wafer processing.

High Capacity Water Cooled Traps

Semiconductor CVD equipment manufacturers require high wafer counts between preventative maintenance. Unlike other manufacturers who offer one solution to fit a number of applications, Nor-Cal will design high-capacity water-cooled traps to achieve specific customer-stated goals. Port geometry, capacity, conductance and efficiency are adjusted in order to produce the optimal design for the application. Examples of processes we have provided solutions for include TiN barrier layer deposition, LPCVD Nitride and III-Vs MOCVD.

Liquid Nitrogen Traps

High capacity liquid nitrogen traps can be furnished for customers who require larger LN² capacity to extend the time between refills or larger trapping capacity for condensable by-products.

Multistage Traps

Multistage traps can be furnished for processes that require a combination of trap media, such as watercooling and particle filtration. The trap shown here was developed for GaAs, GaN, AsP MOCVD processes. The first stage collects the heavy metals, while the water cooled second stage collects sulfur. The third stage particle filter collects any fine particulates.



High capacity particulate trap

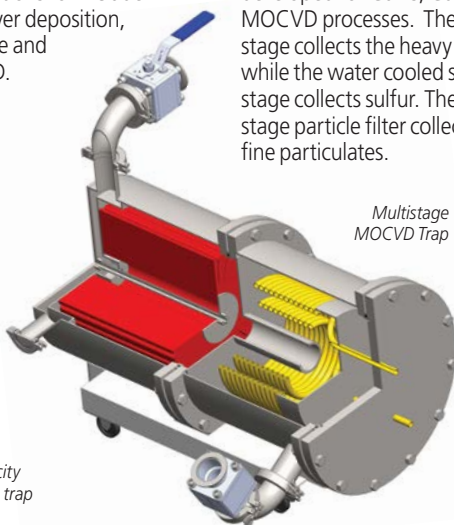

Multistage MOCVD Trap

Foreline Trap Options

When ordering a trap with options, please follow the option tree below.

Note: All options are not available on some body sizes or trap types.

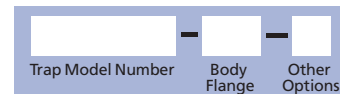

Example: FTPA-6-2002-NWB-BF-L7

Body Flange Option

OPTION	FITS BODY OD
-BF	4 (101.60)
-BF	6 (152.40)
-BF	8 (203.20)

These ISO clamp style flanges are an alternative to V-clamps. Not available on sealed coaxial metal traps, or 2 or 4 1/2 inch (50.8 -114.3mm) trap bodies.

Other Options

These options are trap type specific

Copper Sieve Option

OPTION	FITS TRAP TYPE
-CS	Metal sieve

208-240 Volt Heater Option

OPTION	FITS TRAP TYPE
-240V	Molecular sieve

The standard molecular sieve trap regeneration heater is 120V. 208V - 240V heaters are available as an option at no additional cost. Other voltages are available.

Quick Disconnect Option

OPTION	FITS TRAP TYPE
-QD	Water cooled

Immediately shuts off water flow from both directions for single-handed, no-spill removal of a water cooled trap from the system for preventative maintenance or O-ring replacement.

Fiberglass Particulate Filter Option

For temperatures up to 370°C

OPTION	FITS TRAP TYPE
-F	Particulate

High Capacity Particulate Filter Option

OPTION	FITS TRAP TYPE
-L7	Particulate

This high-capacity fiberglass filter provides a reservoir for applications with heavy particle loads that might block the inlet.

Foreline Traps

Metal Sieve Traps



SPECIFICATIONS

Material

Trap Body: 304 stainless steel
Flanges: 304 stainless steel
Sieve: 304 stainless steel

Vacuum range: $\geq 1 \times 10^{-8}$ mbar

Temperature range: -20°C to 150°C

Options: Copper sieve filters, electropolish, ISO body flange

Nor-Cal Products metal sieve traps are provided with a fibrous stainless steel sieve for removal of hydrocarbons which backstream toward the chamber when the mechanical pump oil is at its vapor pressure. Copper sieve is available as an option at no additional cost. Add "-CS" to 2, 4 and 6 inch (12.4, 101.6 and 152.4mm) model number. The body flange option is also available for 4, 6 and 8 inch (101.6, 152.4 and 203.2mm) trap bodies. Add "-BF" to model number.

Standard designs include a sealed, single piece, coaxial body and a two-piece, clamped body with coaxial or right angle port configurations. The sealed trap design requires removal from the system before cleaning. The two-piece clamped body design makes disassembly, cleaning and sieve replacement a simple task. For proper sealing of two-piece body traps, apply a light coating of Krytox lube when cleaning or replacing the O-ring. Standard body finish is beadblast. Electropolish finish, larger body sizes, CF and ASA flanges are also available. Call for pricing.



Sealed Coaxial Metal Sieve Traps

MODEL NUMBER	BODY OD	FLANGE TYPE	PORT OD	A
CT-2-0502-NWB	2 (50.80)	NW-10B	1/2 (12.70)	8.43 (214.12)
CT-2-0752-NWB	2 (50.80)	NW-16B	3/4 (19.05)	8.43 (214.12)
CT-2-1002-NWB	2 (50.80)	NW-25B	1 (25.40)	8.43 (214.12)
CT-4-0752-NWB	4 (101.60)	NW-16B	3/4 (19.05)	10.30 (261.62)
CT-4-1002-NWB	4 (101.60)	NW-25B	1 (25.40)	10.30 (261.62)
CT-4-1502-NWB	4 (101.60)	NW-40B	1 1/2 (38.10)	10.30 (261.62)
CT-4-2002-NWB	4 (101.60)	NW-50B	2 (50.80)	10.30 (261.62)

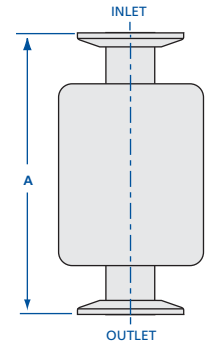

Angle Metal Sieve Traps

MODEL NUMBER	DIAGRAM	BODY OD	FLANGE TYPE	PORT OD	A	B	C	D
FTA-2-0502-NWB	A	2* (50.80)	NW-10B	1/2 (12.70)	6.94 (176.28)	3.56 (90.42)	5.38 (136.65)	2.65 (67.31)
FTA-2-0752-NWB	A	2* (50.80)	NW-16B	3/4 (19.05)	6.94 (176.28)	3.56 (90.42)	5.25 (133.35)	2.65 (67.31)
FTA-2-1002-NWB	A	2* (50.80)	NW-25B	1 (25.40)	6.94 (176.28)	3.56 (90.42)	5.13 (130.30)	2.65 (67.31)
FTA-4-0752-NWB	B	4 (101.60)	NW-16B	3/4 (19.05)	8.65 (219.71)	4.80 (121.92)	6.67 (169.42)	3.65 (92.71)
FTA-4-1002-NWB	B	4 (101.60)	NW-25B	1 (25.40)	8.65 (219.71)	4.80 (121.92)	6.55 (166.37)	3.65 (92.71)
FTA-4-1502-NWB	B	4 (101.60)	NW-40B	1 1/2 (38.10)	8.65 (219.71)	4.80 (121.92)	6.29 (159.77)	3.65 (92.71)
FTA-4-2002-NWB	B	4 (101.60)	NW-50B	2 (50.80)	8.65 (219.71)	4.80 (121.92)	6.04 (153.42)	3.65 (92.71)
FTA-6-1502-NWB	B	6 (152.40)	NW-40B	1 1/2 (38.10)	8.65 (219.71)	6.90 (175.26)	5.15 (130.81)	4.65 (118.11)
FTA-6-2002-NWB	B	6 (152.40)	NW-50B	2 (50.80)	8.65 (219.71)	6.90 (175.26)	4.90 (124.46)	4.65 (118.11)
FTA-6-3002-ISO	B	6 (152.40)	ISO-80-300-OF	3 (76.20)	8.75 (222.25)	6.90 (175.26)	4.87 (123.70)	4.75 (120.65)
FTA-6-4002-ISO	B	6 (152.40)	ISO-100-400-OF	4 (101.60)	8.75 (222.25)	6.90 (175.26)	4.56 (115.82)	4.75 (120.65)
FTA-8-2002-NWB	B	8 (203.20)	NW-50B	2 (50.80)	11.65 (295.91)	9.00 (228.60)	7.78 (197.61)	5.65 (143.51)
FTA-8-3002-ISO	B	8 (203.20)	ISO-80-300-OF	3 (76.20)	11.75 (298.45)	9.00 (228.60)	7.38 (187.45)	5.75 (146.05)
FTA-8-4002-ISO	B	8 (203.20)	ISO-100-400-OF	4 (101.60)	11.75 (298.45)	9.00 (228.60)	6.88 (174.75)	5.75 (146.05)

* ISO body flange option not available for 2 inch (50.8mm) trap bodies

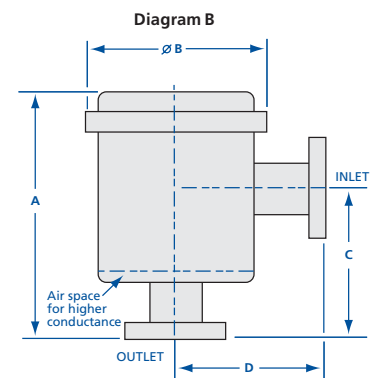
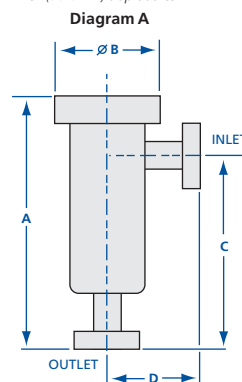

All dimensions are in inches (mm) & weights are in pounds (kg), unless otherwise noted.



Coaxial Metal Sieve Traps

MODEL NUMBER	DIAGRAM	BODY OD	FLANGES	PORT OD	A	B
FCT-2-0502-NWB	A	2* (50.80)	NW-10B	1/2 (12.70)	8.50 (215.90)	3.56 (90.42)
FCT-2-0752-NWB	A	2* (50.80)	NW-16B	3/4 (19.05)	8.50 (215.90)	3.56 (90.42)
FCT-2-1002-NWB	A	2* (50.80)	NW-25B	1 (25.40)	8.50 (215.90)	3.56 (90.42)
FCT-4-0752-NWB	B	4 (101.60)	NW-16B	3/4 (19.05)	10.30 (261.62)	4.80 (121.92)
FCT-4-1002-NWB	B	4 (101.60)	NW-25B	1 (25.40)	10.30 (261.62)	4.80 (121.92)
FCT-4-1502-NWB	B	4 (101.60)	NW-40B	1 1/2 (38.10)	10.30 (261.62)	4.80 (121.92)
FCT-4-2002-NWB	B	4 (101.60)	NW-50B	2 (50.80)	10.30 (261.62)	4.80 (121.92)
FCT-6-1502-NWB	B	6 (152.40)	NW-40B	1 1/2 (38.10)	10.30 (261.62)	6.90 (175.26)
FCT-6-2002-NWB	B	6 (152.40)	NW-50B	2 (50.80)	10.30 (261.62)	6.90 (175.26)
FCT-6-2502-ISO	B	6 (152.40)	ISO-63-250-OF	2 1/2 (63.50)	10.50 (266.70)	6.90 (175.26)
FCT-6-3002-ISO	B	6 (152.40)	ISO-80-300-OF	3 (76.20)	10.50 (266.70)	6.90 (175.26)
FCT-6-4002-ISO	B	6 (152.40)	ISO-100-400-OF	4 (101.60)	10.50 (266.70)	6.90 (175.26)
FCT-8-2002-NWB	B	8 (203.20)	NW-50B	2 (50.80)	13.30 (337.82)	9.00 (228.60)
FCT-8-2502-ISO	B	8 (203.20)	ISO-63-250-OF	2 1/2 (63.50)	13.50 (337.82)	9.00 (128.60)
FCT-8-3002-ISO	B	8 (203.20)	ISO-80-300-OF	3 (76.20)	13.50 (337.82)	9.00 (128.60)
FCT-8-4002-ISO	B	8 (203.20)	ISO-100-400-OF	4 (101.60)	13.50 (337.82)	9.00 (128.60)

* ISO body flange option not available for 2 inch (50.8mm) trap bodies

SPECIFICATIONS

Material

Trap Body: 304 stainless steel
Flanges: 304 stainless steel
Sieve: 304 stainless steel

Vacuum range: $\geq 1 \times 10^{-8}$ mbar

Temperature range: -20°C to 150°C

Options: ISO body flanges, copper sieve filters, electropolish

Copper Sieve Option

Add suffix to trap model number.

OPTION

-CS

The standard metal sieve filter is stainless steel. Copper metal sieve filters are available at no additional cost for all sealed and two-piece metal sieve traps.

Body Flange Option

Add suffix to trap model number.

OPTION

FITS BODY OD

-BF 4 (101.60)

-BF 6 (152.40)

-BF 8 (203.20)

The ISO clamp style flanges are an alternative to V-clamps. Not available on sealed coaxial metal or 2 inch (50.8mm) traps.

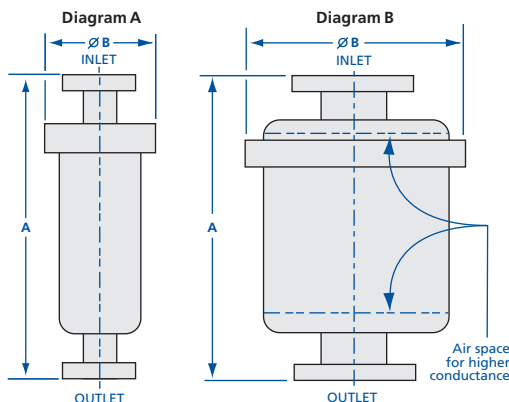

Metal sieve cartridges

Replacement filters and other hardware are located on Page 166



All dimensions are in inches (mm) & weights are in pounds (kg), unless otherwise noted.

Foreline Traps

Molecular Sieve Traps



SPECIFICATIONS

Material

Body: 304 stainless steel
Flanges: 304 stainless steel
Desiccant: Zeolite 13X, 1/8 inch pellets

Vacuum range: $\geq 1 \times 10^{-8}$ mbar

Temperature range: -20°C to 150°C

Options: 240V regeneration heaters and ISO body flanges See page 149

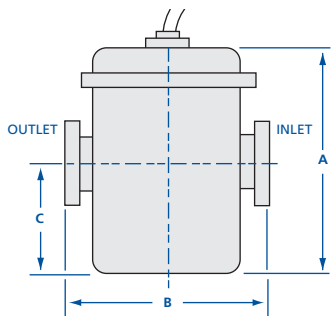
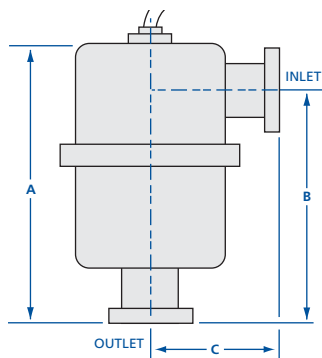
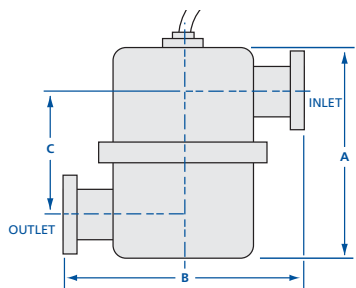

All dimensions are in inches (mm) & weights are in pounds (kg), unless otherwise noted.

These traps perform a dual function. A zeolite desiccant removes hydrocarbons which backstream toward the chamber when the mechanical pump oil is at its vapor pressure. Also, the zeolite traps water vapor and other gasses before they reach the mechanical pump and contaminate the pump oil. Depending on the process, this can reduce the oil change frequency significantly.

Molecular sieve traps utilize the two-piece trap design for ease of maintenance and zeolite replacement. The sieve material is contained in a suspended basket fabricated from perforated 304 stainless steel for maximum conductance to the sieve at the top of the basket as well as around the periphery. A mid-basket baffle causes the gas to enter one-half of the basket and to exit the other half.

When initializing a trap, replacing the sieve or when base pressure cannot be achieved, the sieve should be regenerated by turning on the heater for a few hours and running the mechanical pump with its ballast valve open. The frequency and duration of sieve regeneration is dependent upon the kind and amount of gasses produced by the particular application. To replace the sieve, remove the trap end that contains the heater and remove the nut at the end of the basket. Dump the expired sieve material, replace with new, reattach the basket/end plate then perform the regeneration process outlined above.

A molecular sieve charge and regeneration heater are included with every trap. 208V-240V regeneration heater is available as an option. Other voltages and wattages are available upon request. The heater is held in place allowing the trap to be mounted in any position. Standard finish is beadblasted. Electropolish finish, other body and flange configurations, and larger body sizes are available.

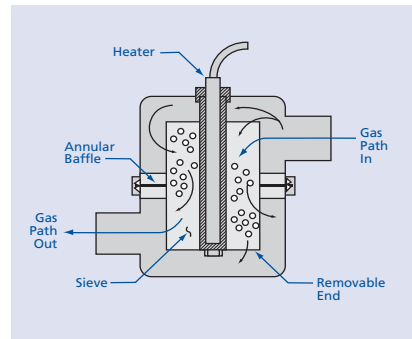

In-Line Molecular Sieve Traps

MODEL NUMBER	BODY OD	FLANGE TYPE	PORT OD	REGENERATION HEATER RATING*	A	B	C
FTM-4-0752-NWB	4 (101.60)	NW-16B	3/4 (19.05)	120V / 42W	6.20 (157.48)	7.30 (185.42)	3.50 (88.90)
FTM-4-1002-NWB	4 (101.60)	NW-25B	1 (25.40)	120V / 42W	6.20 (157.48)	7.30 (185.42)	3.50 (88.90)
FTM-4-1502-NWB	4 (101.60)	NW-40B	1 1/2 (38.10)	120V / 42W	6.20 (157.48)	7.30 (185.42)	3.50 (88.90)
FTM-6-1502-NWB	6 (152.40)	NW-40B	1 1/2 (38.10)	120V / 230W	8.10 (205.74)	9.30 (236.22)	4.10 (104.14)
FTM-6-2002-NWB	6 (152.40)	NW-50B	2 (50.80)	120V / 230W	8.10 (205.74)	9.30 (236.22)	4.10 (104.14)
FTM-8-2002-NWB	8 (203.20)	NW-50B	2 (50.80)	120V / 350W	13.00 (330.20)	11.50 (287.02)	6.75 (171.45)
FTM-8-2502-ISO	8 (203.20)	ISO-63-250-OF	2 1/2 (63.50)	120V / 350W	13.00 (330.20)	11.50 (287.02)	6.75 (171.45)
FTM-8-3002-ISO	8 (203.20)	ISO-80-300-OF	3 (76.20)	120V / 350W	13.00 (330.20)	11.50 (287.02)	6.75 (171.45)
FTM-8-4002-ISO	8 (203.20)	ISO-100-400-OF	4 (101.60)	120V / 350W	13.00 (330.20)	11.50 (287.02)	6.75 (171.45)

Angle Molecular Sieve Traps

MODEL NUMBER	BODY OD	FLANGE TYPE	PORT OD	REGENERATION HEATER RATING*	A	B	C
FTMA-4-0752-NWB	4 (101.60)	NW-16B	3/4 (19.05)	120V / 42W	7.85 (199.39)	6.55 (166.37)	3.65 (92.71)
FTMA-4-1002-NWB	4 (101.60)	NW-25B	1 (25.40)	120V / 42W	7.85 (199.39)	6.55 (166.37)	3.65 (92.71)
FTMA-4-1502-NWB	4 (101.60)	NW-40B	1 1/2 (38.10)	120V / 42W	7.85 (199.39)	6.55 (166.37)	3.65 (92.71)
FTMA-6-1502-NWB	6 (152.40)	NW-40B	1 1/2 (38.10)	120V / 230W	9.75 (247.65)	7.75 (196.85)	4.65 (118.11)
FTMA-6-2002-NWB	6 (152.40)	NW-50B	2 (50.80)	120V / 230W	9.75 (247.65)	7.75 (196.85)	4.65 (118.11)
FTMA-8-2002-NWB	8 (203.20)	NW-50B	2 (50.80)	120V / 350W	14.65 (372.11)	11.53 (292.86)	5.65 (143.51)
FTMA-8-2502-ISO	8 (203.20)	ISO-63-250-OF	2 1/2 (63.50)	120V / 350W	14.75 (374.65)	11.63 (292.86)	5.75 (146.05)
FTMA-8-3002-ISO	8 (203.20)	ISO-80-300-OF	3 (76.20)	120V / 350W	14.75 (374.65)	11.63 (292.86)	5.75 (146.05)
FTMA-8-4002-ISO	8 (203.20)	ISO-100-400-OF	4 (101.60)	120V / 350W	14.75 (374.65)	11.63 (292.86)	5.75 (146.05)

Straight-In-Line Molecular Sieve Traps

MODEL NUMBER	BODY OD	FLANGE TYPE	PORT OD	REGENERATION HEATER RATING*	A	B	C
FTMS-4-0752-NWB	4 (101.60)	NW-16B	3/4 (19.05)	120V / 42W	7.00 (177.80)	7.30 (185.42)	3.50 (88.90)
FTMS-4-1002-NWB	4 (101.60)	NW-25B	1 (25.40)	120V / 42W	7.00 (177.80)	7.30 (185.42)	3.50 (88.90)
FTMS-4-1502-NWB	4 (101.60)	NW-40B	1 1/2 (38.10)	120V / 42W	7.00 (177.80)	7.30 (185.42)	3.50 (88.90)
FTMS-6-1502-NWB	6 (152.40)	NW-40B	1 1/2 (38.10)	120V / 230W	7.00 (177.80)	9.30 (236.22)	3.50 (88.90)
FTMS-6-2002-NWB	6 (152.40)	NW-50B	2 (50.80)	120V / 230W	7.00 (177.80)	9.30 (236.22)	3.50 (88.90)
FTMS-8-2002-NWB	8 (203.20)	NW-50B	2 (50.80)	120V / 350W	10.00 (254.00)	11.30 (287.02)	5.00 (127.00)
FTMS-8-2502-ISO	8 (203.20)	ISO-63-250-OF	2 1/2 (63.50)	120V / 350W	10.00 (254.00)	11.50 (292.10)	5.00 (127.00)
FTMS-8-3002-ISO	8 (203.20)	ISO-80-300-OF	3 (76.20)	120V / 350W	10.00 (254.00)	11.50 (292.10)	5.00 (127.00)
FTMS-8-4002-ISO	8 (203.20)	ISO-100-400-OF	4 (101.60)	120V / 350W	10.00 (254.00)	11.50 (292.10)	5.00 (127.00)

*208V-240V Heater Option

208V-240V heaters are available as an option at no additional cost. Other voltages available. Add option suffix to the end of the trap model number

OPTION	DESCRIPTION
-240V	208V-240V heater



Regeneration heater and Zeolite charge

Replacement charges, heaters & other hardware are located on Page 158

Foreline Traps

Particulate Traps

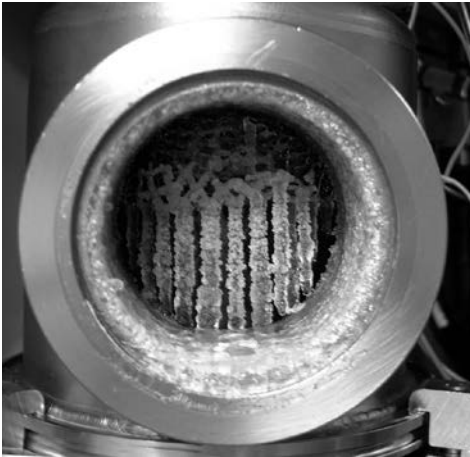

These traps remove particles that might enter the mechanical pump and contaminate the oil. Standard traps include a polyester felt filter traps particles over 10 microns in size at 98% efficiency. Filters can be cleaned with a vacuum cleaner. Suitable for process temperatures from ambient to 149°C. Filters with other micron ratings are available upon request. Woven, 10 micron fiberglass filters are available as an option. They provide a much longer service life than a polyester filter. Fiberglass filter is required for temperatures greater than 149°C. Maximum fiberglass filter temperature is 370°C. Filters with other micron ratings are available upon request.

The high capacity fiberglass filter option, shown in the diagram below, provides a reservoir for applications with heavy particle loads that might block the inlet. The high capacity filter option is not available for 8 inch (203.2mm) bodies.

The two-piece trap body and 304 stainless steel construction allow these traps to be easily cleaned. For proper sealing, apply a light coating of Krytox lube when cleaning or replacing the O-ring. Standard finish is beadblast. Electropolish finish, larger body sizes, ultra-high capacity and custom flange configurations available. Call for pricing.

SPECIFICATIONS

Material
 Trap Body: 304 stainless steel
 Flanges: 304 stainless steel
 Filter: polyester or fiberglass

Vacuum range: $\geq 1 \times 10^{-8}$ mbar

Temperature range: -20°C to 150°C

Options: ISO body flanges, woven fiberglass or high capacity fiberglass filter, electropolish

Angle Particulate Traps

MODEL NUMBER	BODY OD	FLANGES	PORT OD	A	B	C	D
FTP A-6-1502-NWB	6 (152.40)	NW-40B	1½ (38.10)	13.90 (353.06)	6.90 (175.26)	10.40 (264.16)	4.65 (118.11)
FTP A-6-2002-NWB	6 (152.40)	NW-50B	2 (50.80)	13.90 (353.06)	6.90 (175.26)	10.15 (257.81)	4.65 (118.11)
FTP A-8-1502-NWB	8* (203.20)	NW-40B	1½ (38.10)	13.90 (353.06)	9.00 (228.60)	10.40 (264.16)	5.65 (143.51)
FTP A-8-2002-NWB	8* (203.20)	NW-50B	2 (50.80)	13.90 (353.06)	9.00 (228.60)	10.15 (257.81)	5.65 (143.51)
FTP A-8-3002-ISO	8* (203.20)	ISO-80	3 (76.20)	19.35 (491.49)	9.00 (228.60)	15.25 (387.35)	5.65 (143.51)
FTP A-8-4002-ISO	8* (203.20)	ISO-100	4 (101.60)	19.35 (491.49)	9.00 (228.60)	15.25 (387.35)	5.65 (143.51)

* High capacity filter not available for 8 inch (203.2mm) body

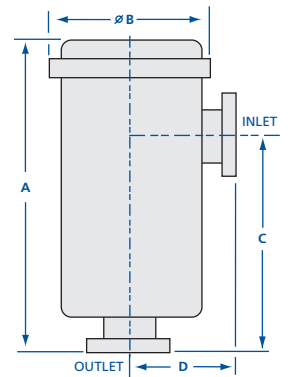

Coaxial Particulate Traps

MODEL NUMBER	BODY OD	FLANGES	PORT OD	A	B
FTP S-6-1502-NWB	6 (152.40)	NW-40B	1½ (38.10)	16.30 (414.02)	6.90 (175.26)
FTP S-6-2002-NWB	6 (152.40)	NW-50B	2 (50.80)	16.30 (414.02)	6.90 (175.26)
FTP S-8-1502-NWB	8* (203.20)	NW-40B	1½ (38.10)	16.30 (414.02)	9.00 (228.60)
FTP S-8-2002-NWB	8* (203.20)	NW-50B	2 (50.80)	16.30 (414.02)	9.00 (228.60)
FTP S-8-3002-ISO	8* (203.20)	ISO-80	3 (76.20)	16.50 (419.10)	9.00 (228.60)
FTP S-8-4002-ISO	8* (203.20)	ISO-100	4 (101.60)	16.50 (419.10)	9.00 (228.60)

* High capacity filter not available for 8 inch (203.2mm) body

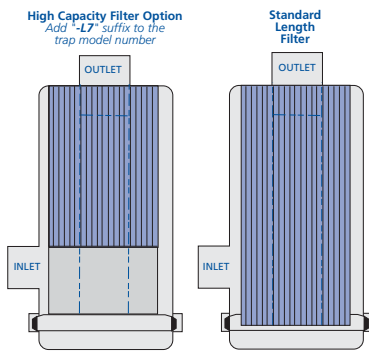
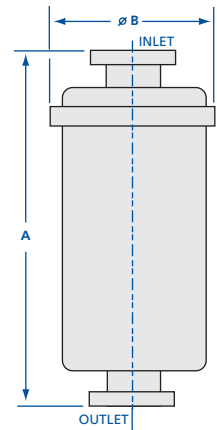

Fiberglass Filter Option

The fiberglass filter option is appropriate for applications with temperatures up to 370°C. The high capacity fiberglass filter provides a reservoir for applications with heavy particle loads that might block the inlet. Add option suffix to the end of the trap model number.

OPTION	FILTER TYPE
-F	Fiberglass
-L7	High capacity

All dimensions are in inches (mm) & weights are in pounds (kg), unless otherwise noted.

Foreline Traps

LPCVD-TEOS Single & Multi-Stage Traps



SPECIFICATIONS

Material

Trap Body: 304 stainless steel

Flanges: 304 stainless steel

Filter: Stainless steel gauze

Vacuum range: $\geq 1 \times 10^{-8}$ mbar

Temperature range: -20°C to 150°C

Increase your system's throughput and extend preventative maintenance intervals by 2X or more with Nor-Cal Products' LPCVD/TEOS multistage foreline traps. The first stage is a stainless steel gauze filter which collects crystalline TEOS before it reaches downstream piping and isolation valves. The second stage is a 10 micron fiberglass filter which removes silicon dioxide which causes frequent PM's in throttling butterfly valves. The third and final stage is a reservoir which collects liquid TEOS without restricting foreline conductance. The two-piece trap body and 304 stainless steel construction allow these traps to be easily cleaned. Standard finish is beadblasted. Electropolish is available on request.



One Stage LPCVD-TEOS Traps

Includes one stainless steel gauze filter

MODEL NUMBER	BODY OD	PORT CONFIGURATION	FLANGES	PORT ID	A	B	C
FTT1S-8-3002-ISO	8 (203.20)	Coaxial	ISO-80	3 (76.20)	16.84 (427.74)	9.00 (228.6)	-
FTT1A-8-3002-ISO	8 (203.20)	Angle	ISO-80	3 (76.20)	15.09 (383.29)	5.75 (146.05)	12.06 (306.32)
FTT1S-8-4002-ISO	8 (203.20)	Coaxial	ISO-100	4 (101.60)	16.84 (427.74)	9.00 (228.6)	-
FTT1A-8-4002-ISO	8 (203.20)	Angle	ISO-100	4 (101.60)	15.09 (383.29)	5.75 (146.05)	12.06 (306.32)

Two Stage LPCVD-TEOS Traps

Includes one stainless steel gauze filter and one 10 micron fiberglass filter

MODEL NUMBER	BODY OD	PORT CONFIGURATION	FLANGES	PORT ID	A	B	C
FTT2S-8-3002-ISO	8 (203.20)	Coaxial	ISO-80	3 (76.20)	19.12 (485.65)	9.45 (240.03)	-
FTT2A-8-3002-ISO	8 (203.20)	Angle	ISO-80	3 (76.20)	21.00 (533.40)	5.75 (146.05)	18.00 (457.20)
FTT2S-8-4002-ISO	8 (203.20)	Coaxial	ISO-100	4 (101.60)	19.12 (485.65)	9.45 (240.03)	-
FTT2A-8-4002-ISO	8 (203.20)	Angle	ISO-100	4 (101.60)	21.00 (433.40)	5.75 (146.05)	18.00 (457.20)

Three Stage LPCVD-TEOS Traps

Includes one stainless steel gauze filter, one 10 micron fiberglass filter, and a built-in liquid collection reservoir

MODEL NUMBER	BODY OD	PORT CONFIGURATION	FLANGES	PORT ID	A	B	C
FTT3S-8-3002-ISO	8 (203.20)	Coaxial	ISO-80	3 (76.20)	19.12 (485.65)	9.45 (240.03)	-
FTT3A-8-3002-ISO	8 (203.20)	Angle	ISO-80	3 (76.20)	21.00 (533.40)	5.75 (146.05)	18.00 (457.20)
FTT3S-8-4002-ISO	8 (203.20)	Coaxial	ISO-100	4 (101.60)	19.12 (485.65)	9.45 (240.03)	-
FTT3A-8-4002-ISO	8 (203.20)	Angle	ISO-100	4 (101.60)	21.00 (433.40)	5.75 (146.05)	18.00 (457.20)

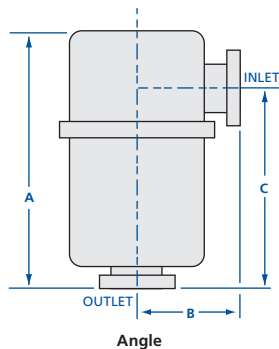
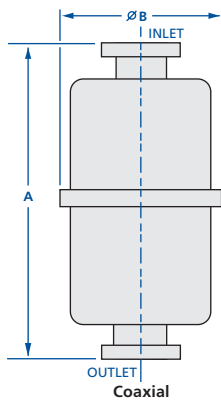

All dimensions are in inches (mm) & weights are in pounds (kg), unless otherwise noted.

Replacement filters and other hardware are located on Page 158



Foreline Traps

Water Cooled Traps



Water cooled traps protect mechanical pumps and other downstream components from condensible process gasses and their by-products, and can extend or eliminate preventative maintenance intervals and pump overhauls. Nor-Cal Products unique water cooled traps have up to three coils of corrosion resistant 316L stainless steel tubing to provide a large cold surface area.

Internal baffles combined with the coils create a perilous path for the gas flow, maximizing resident time and increasing contact between the gas and the coils. Depending on the application, house water or refrigerated water can be used to achieve the required temperature to cause by-products to pass from gas to solid phase. (See chart on page 156) A 30 to 50 psi water supply is required. Anticipate a 1 gpm flow rate at 30 psi.

The two-piece trap body and 304 stainless steel construction allow these traps to be easily cleaned. Standard finish is beadblast. For proper sealing, apply a light coating of Krytox lube when cleaning or replacing the O-ring. Quick Disconnect Fittings immediately shut off water flow from both directions for single handed, no-spill removal of the trap for preventative maintenance or O-ring replacement. Add "-QD" to the trap model number and \$200.00 to price. Electropolish finish, larger body sizes and CF or ASA flanges are also available.

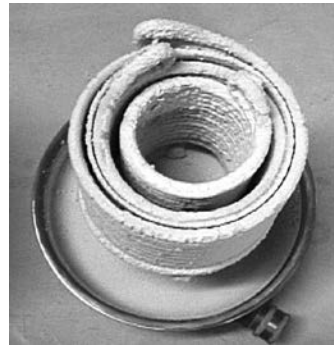

SPECIFICATIONS

Material
 Trap Body: 304 stainless steel
 Flanges: 304 stainless steel
 Water Coils: 316L stainless steel

Vacuum range: $\geq 1 \times 10^{-8}$ mbar

Temperature range: -20°C to 150°C

Options: ISO body flanges and quick disconnect fittings. See page 149

Coaxial Water Cooled Traps

MODEL NUMBER	DIAGRAM	BODY OD	FLANGE TYPE	PORT OD	A	B
FTWS-4.5-1502-NWB	A	4 1/2 (114.30)	NW-40B	1 1/2 (38.10)	9.75 (247.65)	5.28 (134.11)
FTWS-4.5-2002-NWB	A	4 1/2 (114.30)	NW-50B	2 (50.80)	9.75 (247.65)	5.28 (134.11)
FTWS-6-1502-NWB	B	6 (152.40)	NW-40B	1 1/2 (38.10)	10.30 (261.62)	6.90 (175.26)
FTWS-6-2002-NWB	B	6 (152.40)	NW-50B	2 (50.80)	10.30 (261.62)	6.90 (175.26)
FTWS-6-2502-ISO	B	6 (152.40)	ISO-63-250-OF	2 1/2 (63.50)	10.50 (266.70)	6.90 (175.26)
FTWS-6-3002-ISO	B	6 (152.40)	ISO-80-300-OF	3 (76.20)	10.50 (266.70)	6.90 (175.26)
FTWS-8-2002-NWB	B	8 (203.20)	NW-50B	2 (50.80)	13.30 (337.82)	9.00 (228.60)
FTWS-8-2502-ISO	B	8 (203.20)	ISO-63-250-OF	2 1/2 (63.50)	13.50 (342.90)	9.00 (228.60)
FTWS-8-3002-ISO	B	8 (203.20)	ISO-80-300-OF	3 (76.20)	13.50 (342.90)	9.00 (228.60)
FTWS-8-4002-ISO	B	8 (203.20)	ISO-100-400-OF	4 (101.60)	13.50 (342.90)	9.00 (228.60)

*NOTE: ISO body flange option not available for 4 1/2 inch (114.3mm) bodies

Angle Water Cooled Traps

MODEL NUMBER	DIAGRAM	BODY OD	FLANGES	PORT OD	A	B	C	D
FTWA-4.5-1502-NWB	C	4 1/2 (114.30)	NW-40B	1 1/2 (38.10)	7.55 (191.77)	5.28 (134.11)	3.90 (99.06)	6.05 (153.67)
FTWA-4.5-2002-NWB	C	4 1/2 (114.30)	NW-50B	2 (50.80)	7.55 (191.77)	5.28 (134.11)	3.90 (99.06)	6.05 (153.67)
FTWA-6-1502-NWB	D	6 (152.40)	NW-40B	1 1/2 (38.10)	8.65 (219.71)	6.90 (175.26)	4.65 (118.11)	5.40 (137.16)
FTWA-6-2002-NWB	D	6 (152.40)	NW-50B	2 (50.80)	8.65 (219.71)	6.90 (175.26)	4.65 (118.11)	5.40 (137.16)
FTWA-6-2502-ISO	D	6 (152.40)	ISO-63-250-OF	2 1/2 (63.50)	8.75 (222.25)	6.90 (175.26)	4.75 (120.65)	5.50 (139.70)
FTWA-6-3002-ISO	D	6 (152.40)	ISO-80-300-OF	3 (76.20)	8.75 (222.25)	6.90 (175.26)	4.75 (120.65)	5.50 (139.70)
FTWA-8-2002-NWB	D	8 (203.20)	NW-50B	2 (50.80)	11.65 (295.91)	9.00 (228.60)	5.65 (143.51)	6.77 (171.96)
FTWA-8-2502-ISO	D	8 (203.20)	ISO-63-250-OF	2 1/2 (63.50)	11.75 (298.45)	9.00 (228.60)	5.75 (146.05)	7.87 (199.90)
FTWA-8-3002-ISO	D	8 (203.20)	ISO-80-300-OF	3 (76.20)	11.75 (298.45)	9.00 (228.60)	5.75 (146.05)	6.87 (174.50)
FTWA-8-4002-ISO	D	8 (203.20)	ISO-100-400-OF	4 (101.60)	11.75 (298.45)	9.00 (228.60)	5.75 (146.05)	6.87 (174.50)

*NOTE: ISO body flange option not available for 4 1/2 inch (114.3mm) bodies

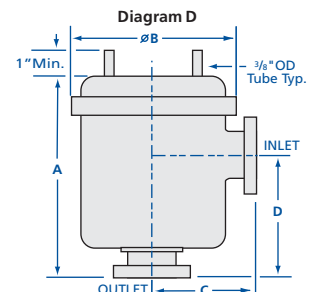
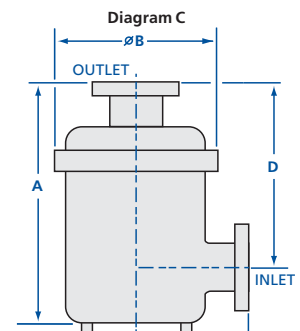
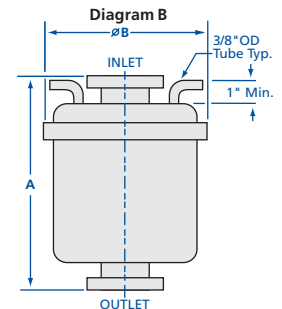
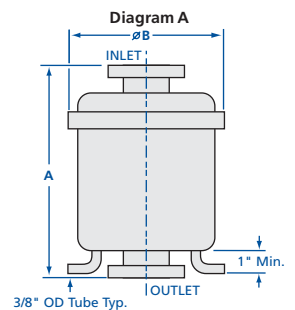

Quick Disconnect Option

Add Suffix to trap model number.

OPTION	FITS TRAP TYPE
-QD	Water cooled

Immediately shuts off water flow from both directions for single-handed, no-spill removal of a water cooled trap from the system for preventative maintenance or O-ring replacement.

Quick disconnect fittings & mounting hardware are located on Page 158



Foreline Traps

Liquid Nitrogen Traps

SPECIFICATIONS

- Material**
Trap Body: 304 stainless steel
Flanges: 304 stainless steel
- Vacuum range:** $\geq 1 \times 10^{-8}$ mbar
- Temperature range:** -20°C to 150°C
- Options:** ISO body flanges. See page 149

Nor-Cal's liquid nitrogen traps remove condensable gases before they enter the mechanical pump and contaminate the oil. They also prevent mechanical pump oil vapors from contaminating the vacuum chamber. These traps actually act as a pump producing lower base pressures and faster pump down. Dual-tube traps can be attached to an automatic fill device, eliminating the necessity of manually refilling the reservoir with liquid nitrogen.

The two-piece trap body and 304 stainless steel construction allow these traps to be easily cleaned without disassembling the system. For proper sealing, apply a light coating of Krytox lube when cleaning or replacing the O-ring. Coaxial port configurations, ISO, CF or ASA flanges, electropolish finish and drain fittings are available.

Refill Time Table for Single Tube LN² Traps

TRAP DIAMETER	HOURS
4 inch (101.60)	5
6 inch (152.40)	8
8 inch (203.20)	12

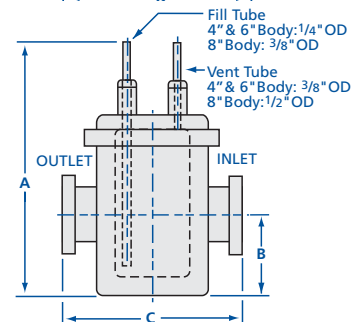
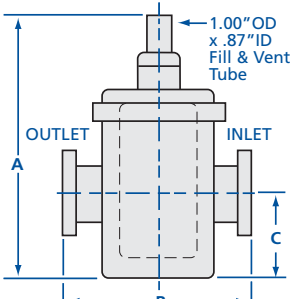
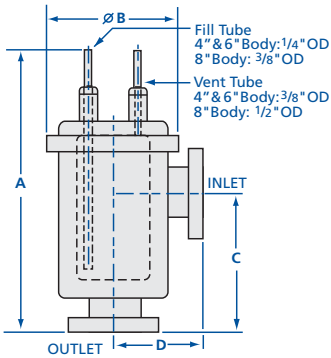
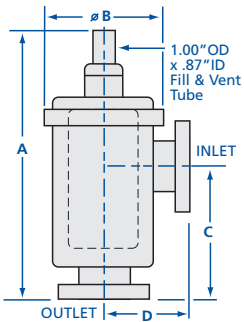

Angle Liquid Nitrogen Traps

MODEL NUMBER	BODY OD	FLANGES	PORT OD	A	B	C	D	LN ₂ RESERVOIR
FTNA-4-0752-NWB	4 (101.60)	NW-16B	3/4 (19.05)	13.15 (334.01)	4.80 (121.92)	7.18 (182.37)	3.65 (92.71)	0.75 Liter
FTNA-4-1002-NWB	4 (101.60)	NW-25B	1 (25.40)	13.15 (334.01)	4.80 (121.92)	7.06 (182.37)	3.65 (92.71)	0.75 Liter
FTNA-4-1502-NWB	4 (101.60)	NW-40B	1 1/2 (38.10)	13.15 (334.01)	4.80 (121.92)	6.80 (172.72)	3.65 (92.71)	0.75 Liter
FTNA-6-1502-NWB	6 (152.40)	NW-40B	1 1/2 (38.10)	15.85 (402.59)	6.90 (175.26)	8.40 (213.36)	4.65 (118.11)	1.60 Liter
FTNA-6-2002-NWB	6 (152.40)	NW-50B	2 (50.80)	15.85 (402.59)	6.90 (175.26)	8.15 (207.01)	4.65 (118.11)	1.60 Liter
FTNA-8-1502-NWB	8 (203.20)	NW-40B	1 1/2 (38.10)	16.90 (429.26)	9.00 (228.60)	9.15 (232.41)	5.65 (143.51)	4.00 Liter
FTNA-8-2002-NWB	8 (203.20)	NW-50B	2 (50.80)	16.90 (429.26)	9.00 (228.60)	8.90 (226.06)	5.65 (143.51)	4.00 Liter

Angle Dual-Tube Liquid Nitrogen Traps

MODEL NUMBER	BODY OD	FLANGES	PORT OD	A	B	C	D	LN ₂ RESERVOIR
NTDA-4-0752-NWB	4 (101.60)	NW-16B	3/4 (19.05)	13.15 (334.01)	4.80 (121.92)	7.18 (182.37)	3.65 (92.71)	0.75 Liter
NTDA-4-1002-NWB	4 (101.60)	NW-25B	1 (25.40)	13.15 (334.01)	4.80 (121.92)	7.06 (182.37)	3.65 (92.71)	0.75 Liter
NTDA-4-1502-NWB	4 (101.60)	NW-40B	1 1/2 (38.10)	13.15 (334.01)	4.80 (121.92)	6.80 (172.72)	3.65 (92.71)	0.75 Liter
NTDA-6-1502-NWB	6 (152.40)	NW-40B	1 1/2 (38.10)	15.85 (402.59)	6.90 (175.26)	8.40 (213.36)	4.65 (118.11)	1.60 Liter
NTDA-6-2002-NWB	6 (152.40)	NW-50B	2 (50.80)	15.85 (402.59)	6.90 (175.26)	8.15 (207.01)	4.65 (118.11)	1.60 Liter
NTDA-8-1502-NWB	8 (203.20)	NW-40B	1 1/2 (38.10)	16.90 (429.26)	9.00 (228.60)	9.15 (232.41)	5.65 (143.51)	4.00 Liter
NTDA-8-2002-NWB	8 (203.20)	NW-50B	2 (50.80)	16.90 (429.26)	9.00 (228.60)	8.90 (226.06)	5.65 (143.51)	4.00 Liter

In-Line Liquid Nitrogen Traps

MODEL NUMBER	BODY OD	FLANGES	PORT OD	A	B	C	LN ₂ RESERVOIR
FTN-4-0752-NWB	4 (101.60)	NW-16B	3/4 (19.05)	11.50 (292.10)	7.30 (185.42)	3.70 (93.98)	0.75 Liter
FTN-4-1002-NWB	4 (101.60)	NW-25B	1 (25.40)	11.50 (292.10)	7.30 (185.42)	3.70 (93.98)	0.75 Liter
FTN-4-1502-NWB	4 (101.60)	NW-40B	1 1/2 (38.10)	11.50 (292.10)	7.30 (185.42)	3.70 (93.98)	0.75 Liter
FTN-6-1502-NWB	6 (152.40)	NW-40B	1 1/2 (38.10)	14.20 (360.68)	9.30 (236.22)	4.50 (114.30)	1.60 Liter
FTN-6-2002-NWB	6 (152.40)	NW-50B	2 (50.80)	14.20 (360.68)	9.30 (236.22)	4.50 (114.30)	1.60 Liter
FTN-8-1502-NWB	8 (203.20)	NW-40B	1 1/2 (38.10)	15.25 (387.35)	11.30 (287.02)	5.00 (127.00)	4.00 Liter
FTN-8-2002-NWB	8 (203.20)	NW-50B	2 (50.80)	15.25 (387.35)	11.30 (287.02)	5.00 (127.00)	4.00 Liter

In-Line Dual-Tube Liquid Nitrogen Traps

MODEL NUMBER	BODY OD	FLANGES	PORT OD	A	B	C	LN ₂ RESERVOIR
NTD-4-0752-NWB	4 (101.60)	NW-16B	3/4 (19.05)	11.50 (292.10)	3.70 (93.98)	7.30 (185.42)	0.75 Liter
NTD-4-1002-NWB	4 (101.60)	NW-25B	1 (25.40)	11.50 (292.10)	3.70 (93.98)	7.30 (185.42)	0.75 Liter
NTD-4-1502-NWB	4 (101.60)	NW-40B	1 1/2 (38.10)	11.50 (292.10)	3.70 (93.98)	7.30 (185.42)	0.75 Liter
NTD-6-1502-NWB	6 (152.40)	NW-40B	1 1/2 (38.10)	14.20 (360.68)	4.50 (114.30)	9.30 (236.22)	1.60 Liter
NTD-6-2002-NWB	6 (152.40)	NW-50B	2 (50.80)	14.20 (360.68)	4.50 (114.30)	9.30 (236.22)	1.60 Liter
NTD-8-1502-NWB	8 (203.20)	NW-40B	1 1/2 (38.10)	15.25 (387.35)	5.00 (127.00)	11.30 (287.02)	4.00 Liter
NTD-8-2002-NWB	8 (203.20)	NW-50B	2 (50.80)	15.25 (387.35)	5.00 (127.00)	11.30 (287.02)	4.00 Liter

Foreline Traps

Oil Mist Eliminators



During rotary vane pump operation, oil mist escapes from the exhaust port; mainly when pumping between atmospheric pressure and 1 mbar. Safe operation of a rotary vane pump requires an Oil Mist Eliminator (OME) to be mounted above the pump's exhaust port. The oil mist is present in exhaust gases with a high level of separation. These mists present a potential environmental and health hazard as well as creating an oily build-up on everything in the pump's proximity. Misting increases as exhaust pressure increases.



SPECIFICATIONS

Material

Trap Body: 304 stainless steel, aluminum or Polyamide
Filter: Epoxy/glass microfiber, Polypropylene

The OME's filtration system contains the mist and returns it to the pump body. The OME's internal over-pressure valve prevents vapor explosions due to exceeding the maximum permissible exhaust pressure. Oil mist eliminators do not trap gas.

Caution: Vent all processes properly. Oil mist eliminators are not recommended for applications with high oxygen, silane, or condensable vapor content. Seal kits, auto drain kits, and other accessories are available. Call for pricing.

Oil Mist Eliminators

MODEL NUMBER	DIAGRAM	PROCESS USAGE	BODY MATERIAL	FLANGE TYPE
FTOME-25-S	A	General, non-corrosive	Polyamide	NW-25
FTOME-25-HP	B	General, non-corrosive. For frequent cycling or high pressure operation	Aluminum	NW-25
FTOME-40-S	C	General, non-corrosive	Aluminum	NW-40
FTOME-40-C2	D	Fluorinated, corrosive	Stainless Steel	NW-40

Replacement Filters

MODEL NUMBER	USE WITH	FILTER MATERIAL	QUANTITY
FTOME-25-S-F	FTOME-25-S	Epoxy/glass microfiber	1
FTOME-25-HP-F	FTOME-25-HP	Epoxy/glass microfiber	1
FTOME-40-S-F	FTOME-40-S	Epoxy/glass microfiber	1
FTOME-40-C2-F	FTOME-40-C2	Polypropylene	1

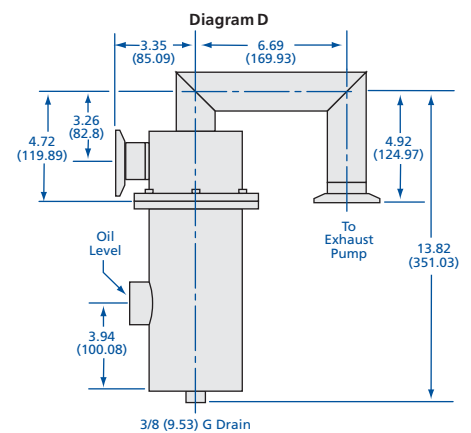
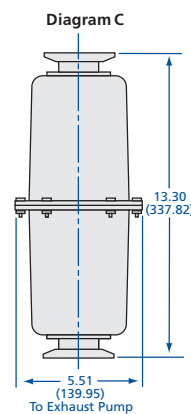
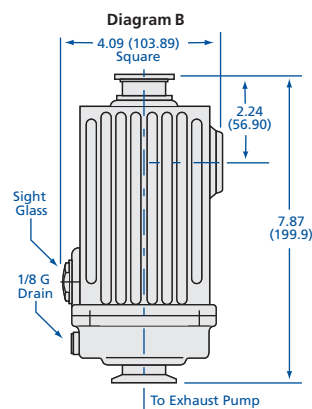
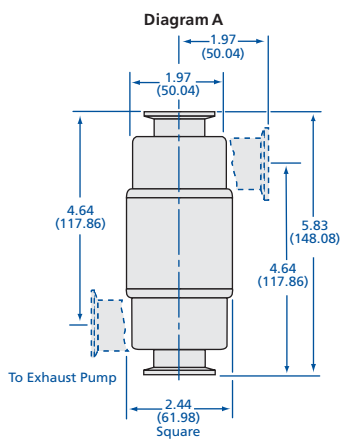

All dimensions are in inches (mm) & weights are in pounds (kg), unless otherwise noted.

Foreline Traps

Filters, Hardware & Accessories



Metal sieve trap filters

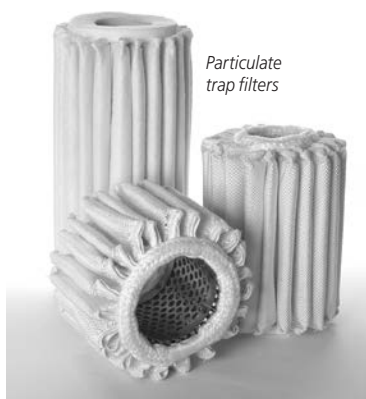

Particulate trap filters



Molecular sieve trap heaters



Molecular sieve trap charge



Metal Sieve Trap Replacement Filters

MODEL NUMBER	BODY OD	DESCRIPTION
FT-2-SS	2 (50.80)	Stainless steel gauze
FT-2-CS	2 (50.80)	Copper gauze
FT-4-SS	4 (101.60)	Stainless steel gauze
FT-4-CS	4 (101.60)	Copper gauze
FT-6-SS	6 (152.40)	Stainless steel gauze
FT-6-CS	6 (152.40)	Copper gauze
FT-8-SS	8 (203.20)	Stainless steel gauze



Trap mounting bracket

Particulate Trap Replacement Filters

MODEL NUMBER	BODY OD	FILTER LENGTH	DESCRIPTION
FT-6-PP	6 or 8 (152.40 or 203.20)	11½ (292.10)	Polyester felt, 10 micron
FT-6-PF	6 or 8 (152.40 or 203.20)	11½ (292.10)	Woven fiberglass, 10 micron
FT-6-PF-L7	6 (152.40)	7½ (190.50)	Woven fiberglass filter, 10 micron
FT-8-PR	8 (152.40)	11½ (292.10)	Polypropylene filter, 10 micron

LPCVD-TEOS Trap Replacement Filters

MODEL NUMBER	BODY OD	FILTER MATERIAL	FITS TRAPS
FT-8-SS	8 (203.20)	Stainless steel gauze	FTT1
FT-8-SS-5	8 (203.20)	Stainless steel gauze	FTT2 and FTT3
FT-8-PF-5	8 (203.20)	Woven fiberglass	FTT2 and FTT3

Molecular Sieve Trap Replacement Heaters

MODEL NUMBER	BODY OD	DESCRIPTION
FT-4-HRF	4 (101.60)	Rated at 120V, 42W
FT-4-HRF-240V	4 (101.60)	Rated at 240V, 42W
FT-6-HR	6 (152.40)	Rated at 120V, 230W
FT-6-HR-240V	6 (152.40)	Rated at 240V, 42W
FT-8-HR	8 (203.20)	Rated at 120V, 350W
FT-8-HR-240V	8 (203.20)	Rated at 240V, 350W

Molecular Sieve Trap Replacement Charges

MODEL NUMBER	BODY OD	DESCRIPTION
FT-4-MS	4 (101.60)	1 lb. Zeolite charge, 4 inch (101.60) trap requires ¾ lb.
FT-6-MS	6 (152.40)	2 lb. Zeolite charge, 6 inch (152.40) trap requires 1½ lb.
FT-8-MS	8 (203.20)	5 lb. Zeolite charge, 8 inch (203.20) trap requires 4¾ lb.

Water Cooled Trap Fittings

MODEL NUMBER	BODY OD	DESCRIPTION
FTW-QD	All	Quick disconnect fittings kit (DESO)
FTW-4.5-OR	4½ (114.30)	Internal FKM O-ring used in this body size only

Body Clamps

Body clamps for use with all trap types

MODEL NUMBER	BODY OD
NW-50-CP	2 (50.80)
FT-4-CP	4 (101.60)
FT-4.5-CP	4½ (114.30)
FT-6-CP	6 (152.40)
FT-8-CP	8 (203.20) below S/N292800
50248	8 (203.20) above S/N 292800
FT-CP-B	T-bolt kit*

* T-bolt kits include replacement bolts and nuts for all size V-band clamps and brackets.

Body O-rings

For use with all foreline trap types.

MODEL NUMBER	BODY OD
NW-50-OR-V	2 (50.80)
FT-4-OR	4 (101.60)
FT-4.5-OR	4½ (114.30)
FT-6-OR	6 (152.40)
FT-8-OR	8 (203.20) below S/N 292800
FT-8-OR-821	8 (203.20) above S/N 292800

Mounting Brackets

For mounting all 6 inch trap types.

MODEL NUMBER	BODY OD
FT-6-MB	6 (152.40)

Order Information

Regional Sales Contacts

Nor-Cal Products



by PFEIFFER VACUUM

Manufacturing & Corporate Global Headquarters

1967 South Oregon Street, Yreka, CA 96097

Phone: 530-842-4457 | Toll Free: 800-824-4166 | Fax: 530-842-9189

Silicon Valley Sales & Applications Office

3375 Scott Blvd., Suite 100, Santa Clara, CA 95054

Phone: 408-980-8992 | Fax: 408-980-8947 | E-mail: ncsales@n-c.com

DIRECT SALES:

www.n-c.com | 1-800-824-4166 | ncsales@n-c.com

Locate your
sales representative
at
www.n-c.com/sales
or call
800-824-4166
for assistance

Send drawings
and quote
requests to
ncsales@n-c.com

Follow us on
LinkedIn

Sylvie Bouhier

*European
Regional Sales Manager*

Ph: +44 (0)799 057 1405
sbouhier@nor-cal.eu

Nor-Cal Products, Europe

Suite D, Dittons Engineering Park
Dittons Road, Polegate BN26 6HY
United Kingdom

Ph: +44 (0)1323 810 854

www.nor-cal.eu

Lena Tan

*Asia-Pacific
Regional Sales Manager*

Ph: +65 6634-1228
sales@n-c.asia

Nor-Cal Products, Asia Pacific

2 Ang Mo Kio Street 64 #01-03A
ECON Industrial Building
Singapore 569084

MAILING ADDRESS:

Nor-Cal Products, Asia Pacific

Serangoon Garden
P. O. Box 428
Singapore 915531

IT Jang

*South Korea
Regional Sales Manager*

Ph: +82-10-7554-0117
itjang@n-c.com

Nor-Cal Products, South Korea

Gadong 2nd Floor, 531-8 Gajang-ro,
Osan-si, Gyeonggi-do,
South Korea, 18103
Republic of Korea

Ph: +82-31-8003-1341

Fax: +82-31-8003-1342

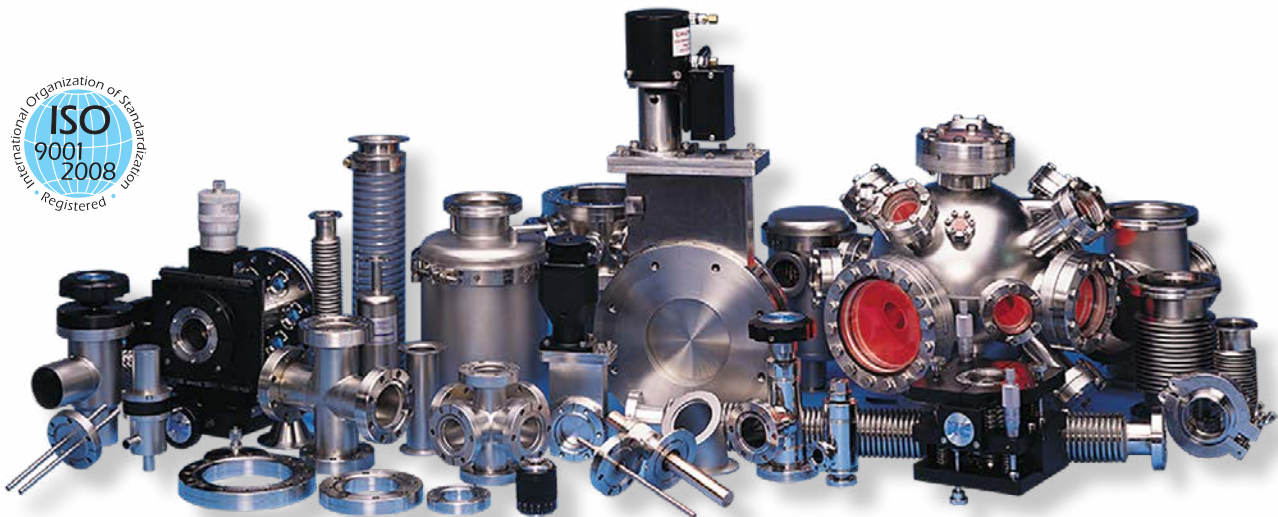

Terms & Conditions of Sale

Payment terms are net 30 days from the date of the invoice once credit has been approved. Otherwise, C.O.D. Most major credit cards are accepted.

If payment in full is not received within 30 days, a 1.5% per month late charge may be added to the unpaid balance. Discounts may be revoked if an account is not paid within these terms.

MINIMUM ORDERS: The minimum domestic order is \$40. The minimum international order is \$100.00.

QUANTITY PRICING:

Quantity pricing is valid on single shipments only.

AVAILABILITY: Our inventory is updated automatically, but there is always a possibility that an item may be unavailable or sold-out. If this occurs, customers are notified as soon as possible and alternative options are offered if available.

PACKAGING: The factory will determine the most cost effective method to package items for shipment. A \$5.00 USD per cardboard box charge will be applied to all orders with a maximum charge of \$25.00 USD per shipment. Large products requiring a wooden crate will be charged an amount consistent with the fabrication of the necessary crate.

FOB POINT: All orders ship FOB Yreka from 1967 S. Oregon, Yreka, California, 96097, USA unless quoted otherwise.

LOST OR DAMAGED ITEMS: Nor-Cal does not assume responsibility for items lost or damaged in transit, or for any direct or indirect damages incurred. Shipping damages are to be handled by the customer. Nor-Cal will provide the tracking number and contact information for the shipping company as needed. All items are purchased at the customer's risk.

EXPORTED COMMODITIES: US Export administration Regulations must be followed. Diversion contrary to US Law is prohibited.

Pricing & Dimensions

In order to meet the changing needs of our customers we periodically make design revisions in our standard product line. As a result, the dimensions, pricing and specifications are subject to change without notice. International pricing may also vary.

SPECIAL TOOLING: Products ordered to non-standard specifications should state specification requirements in detail. Fee for special tooling may apply. On request, test report(s) and/or certification(s) can be supplied at additional cost.

Discounts

OEM and quantity discounts are available to qualified customers.

Return Policy

An RMA (Return Materials Authorization) number must be obtained from Nor-Cal Products before returning any merchandise. The RMA form can be found under SUPPORT in the footer of pages at www.n-c.com. To expedite the assignment of an RMA number, complete the form online and submit online. You may also print and email the completed form to rma@n-c.com or fax to the attention of the RMA Coordinator at 866-640-9012.

- Nor-Cal Products reserves the right to refuse the return of non-stocked items. A twenty-five (25) percent restocking fee may be charged.
- Nor-Cal Products shall incur no liability for damage, shortages or other cause alleged to have occurred at, or prior to, delivery to the carrier unless buyer shall have entered full details thereof on its receipt to the carrier. Products over 60 days old from the date of shipment will not be accepted for return.
- Nor-Cal Products must be allowed time to investigate all returns.

Cancellations & Rescheduling

Any request by customers to reschedule or cancel in total or part of any purchase order must be approved at the sole discretion of Nor-Cal Products and shall be subject to the following conditions. Nor-Cal must receive written notice of Request for Cancellation or Reschedule, stating the reasons therefore.

Customer shall be liable for payment of the following charges to Nor-Cal in the event of Cancellation or Reschedule.

- For all charges incurred (including overhead, G&A, and profit) prior to the date that notice of cancellation is received by Nor-Cal for all parts peculiar to customer's requirements. Upon payment by the customer of these charges, such parts become the property of customer, Nor-Cal will store said parts for a reasonable period of time pending the receipt of customer's instructions for disposition. Such storage is at customer's risk and may be subject to storage charges if stored by Nor-Cal for longer than 30 days from the cancellation date; plus
- Charges to convert modified standard parts for return to Nor-Cal's inventory; plus
- A restocking charge of twenty (25) percent of the purchase price of the cancelled item.

Warranty Products manufactured by Nor-Cal Products are warranted against defects in material and workmanship for a period of twelve (12) months from the date of shipment from Nor-Cal Products to the buyer. Any modification to the product by the buyer or their agent voids this warranty. Liability under this warranty is expressly limited to the replacement or repair (at Nor-Cal Products' option) of defective parts. Nor-Cal Products may at any time discharge its warranty as to any of its products by refunding the purchase price and taking back the products. This warranty applies only to parts manufactured and labor provided by Nor-Cal Products under valid warranty claims received by Nor-Cal Products within the applicable warranty period and shall be subject to the terms and conditions hereof.

- Expendable items such as tubes, heaters, sources, bellows, etc., by their nature, may not function for one year; if such items fail to give reasonable service for a reasonable period of time, as determined solely by Nor-Cal Products, they will be repaired or replaced by Nor-Cal Products at its election.
- All warranty replacement or repair of parts shall be limited to equipment malfunctions which, in the sole opinion of Nor-Cal Products, are due or traceable to defects in original materials or workmanship. Malfunctions caused by abuse or neglect of the equipment are expressly not covered by this warranty. Nor-Cal Products expressly disclaims responsibility for any loss or damage caused by the use of its products other than in accordance with proper operating and safety procedures. Reasonable care must be taken by the user to avoid hazards.
- The buyer shall give Nor-Cal Products prompt notice of any claim under this warranty. If Nor-Cal Products, in its sole discretion, determines that the product does not conform to this warranty, Nor-Cal Products shall replace or repair the product free of charge. If such replacement or repair is not feasible, Nor-Cal Products may, at its sole option, refund the purchase price.
- In-warranty repaired or replacement parts are warranted only for the remaining unexpired portion of the original warranty period applicable to the parts which have been repaired or replaced.
- After the expiration of the applicable warranty period, the buyer shall be charged at Nor-Cal Products' then current prices for parts and labor plus transportation.
- Except as stated herein, Nor-Cal Products makes no warranty, expressed or implied (either in fact or operation of law), statutory or otherwise: and, except as stated herein, Nor-Cal Products shall have no liability for special or consequential damages of any kind or from any cause arising out of the sale, installation, or use of any of its products. Statements made by any person, including representatives of Nor-Cal Products, which are inconsistent or in conflict with the terms of this warranty shall not be binding upon Nor-Cal unless reduced to writing and approved by an officer of Nor-Cal Products.
- This warranty shall not extend to any product, that in Nor-Cal Products' judgment, has been affected by damage or wear resulting from operations performed after the sale, or misuse, abrasion, negligence, accident, tampering, faulty installation, inadequate maintenance, damage or casualty.

DISCLAIMER OF WARRANTY: NOR-CAL MAKES NO WARRANTIES WITH RESPECT TO THIS SALE, WHETHER EXPRESSED OR IMPLIED, EXCEPT AS STATED HEREIN, NOR-CAL PRODUCTS MAKES NO WARRANTY OF MERCHANTABILITY OR FITNESS FOR A PARTICULAR PURPOSE.

LIMITATION OF REMEDY AND DAMAGES: THE EXCLUSIVE REMEDY OF THE BUYER WITH RESPECT TO THE TRANSACTIONS CONTEMPLATED HEREIN SHALL BE THE REPLACEMENT OR REPAIR OF SAID PRODUCTS, OR THE RETURN OF THE PURCHASE PRICE, AS SET FORTH UNDER "WARRANTY".

EXCEPT AS HEREIN PROVIDED, EVERY FORM OF LIABILITY FOR DIRECT OR CONSEQUENTIAL DAMAGE FOR LOSS, ARISING FROM CONTRACT, TORT OR OTHERWISE, IS EXPRESSLY EXCLUDED AND DENIED, INCLUDING WITHOUT LIMITATION, LOSS OR DAMAGES TO BUILDINGS, CONTENTS, PRODUCTS OR PERSONS.

Order Information

Patents & Trademarks

Nor-Cal Products, Inc. patents and trademarks:

Genesis Modular Valves are manufactured under patent number 6289932

Intellisys Pressure Control Products are manufactured under patent number 6612331

Genesis is a trademark of Nor-Cal Products, Inc.

Intellisys is a registered trademark of Nor-Cal Products, Inc.

Other registered patents and trademarks:

Magnetic Linear/Rotary Feedthroughs are manufactured under patent number 5514925

Sample Transfer Systems are manufactured under patent number 5705128

Alumel is a registered trademark of Concept Alloys, Inc.

Cajon is a registered trademark of Swagelok Company

Chemraz is a registered trademark of Greene Tweed Company

Chromel is a registered trademark of Concept Alloys, Inc.

ConFlat is a registered trademark of Varian Associates Corp.

DeviceNet is a trademark of the Open DeviceNet Vendor Association (ODVA)

Dupra is a registered trademark of Daikin Industries, Ltd.

Ethernet is a trademark of Xerox Corporation

EVAC-CeFix is a registered trademark of EVAC AG

Inconel is a registered trademark of Special Metals Corp.

KF is a registered trademark of Leybold Vacuum Products Inc.

Kalrez is a registered trademark of DuPont Dow Elastomers

Kovar is a registered trademark of CRS Holdings Inc.

Macor is a registered trademark of Corning, Inc.

Microdot is a registered trademark of Tyco Electronics Corp.

Modbus is a registered trademark of Schneider Electric USA Inc.

Omicron is a registered trademark of Omicron Electric GmbH

Pendurroll is a patented technology of V-Tex Corporation

Perlast is a registered trademark of Precision Polymer Engineering LTD.

SolidWorks is a registered trademark of Dassault Systèmes SolidWorks Corp.

Swagelok is a registered trademark of Swagelok Company

UL is a registered trademark of Underwriters Laboratories, Inc.

VCR is a registered trademark of Swagelok Company

Windows is a registered trademark of Microsoft Corporation

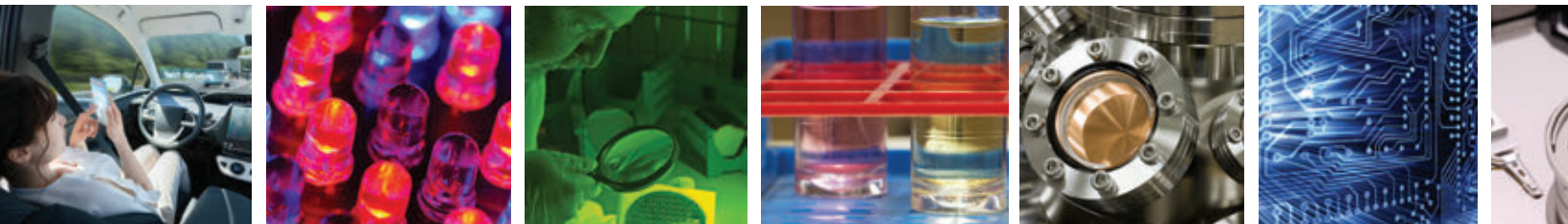

Nor-Cal Products



by PFEIFFER VACUUM

Nor-Cal Products, Inc.
1967 South Oregon Street
Yreka, California 96097
800-824-4166 or 530-842-4457
Fax: 530-841-9189
www.n-c.com