



FRG-700

Inverted Magnetron Pirani Gauge

INSTRUCTION MANUAL

FRG-700 Inverted Magnetron Pirani Gauge



Copyright 2008
Vacuum Technologies

Warranty

Products manufactured by Seller are warranted against defects in materials and workmanship for twelve (12) months from date of shipment thereof to Customer, and Seller's liability under valid warranty claims is limited, at the option of Seller, to repair, to replace, or refund of an equitable portion of the purchase price of the Product. Items expendable in normal use are not covered by this warranty. All warranty replacement or repair of parts shall be limited to equipment malfunctions which, in the sole opinion of Seller, are due or traceable to defects in original materials or workmanship. All obligations of Seller under this warranty shall cease in the event of abuse, accident, alteration, misuse, or neglect of the equipment. In-warranty repaired or replaced parts are warranted only for the remaining unexpired portion of the original warranty period applicable to the repaired or replaced parts. After expiration of the applicable warranty period, Customer shall be charged at the then current prices for parts, labor, and transportation.

Reasonable care must be used to avoid hazards. Seller expressly disclaims responsibility for loss or damage caused by use of its Products other than in accordance with proper operating procedures.

Except as stated herein, Seller makes no warranty, express or implied (either in fact or by operation of law), statutory or otherwise; and, except as stated herein, Seller shall have no liability under any warranty, express or implied (either in fact or by operation of law), statutory or otherwise. Statements made by any person, including representatives of Seller, which are inconsistent or in conflict with the terms of this warranty shall not be binding upon Seller unless reduced to writing and approved by an officer of Seller.

Warranty Replacement and Adjustment

All claims under warranty must be made promptly after occurrence of circumstances giving rise thereto, and must be received within the applicable warranty period by Seller or its authorized representative. Such claims should include the Product serial number, the date of shipment, and a full description of the circumstances giving rise to the claim. Before any Products are returned for repair and/or adjustment, written authorization from Seller or its authorized representative for the return and instructions as to how and where these Products should be returned must be obtained. Any Product returned to Seller for examination shall be prepaid via the means of transportation indicated as acceptable by Seller. Seller reserves the right to reject any warranty claim not promptly reported and any warranty claim on any item that has been altered or has been returned by non-acceptable means of transportation. When any Product is returned for examination and inspection, or for any other reason, Customer shall be responsible for all damage resulting from improper packing or handling, and for loss in transit, notwithstanding any defect or non-conformity in the Product. In all cases, Seller has the sole responsibility for determining the cause and nature of failure, and Seller's determination with regard thereto shall be final.

If it is found that Seller's Product has been returned without cause and is still serviceable, Customer will be notified and the Product returned at Customer's expense; in addition, a charge for testing and examination may be made on Products so returned.

3/1/00

Product Identification

In all communications with VARIAN, please specify the information given on the product nameplate. For convenient reference copy that information into the space provided below:

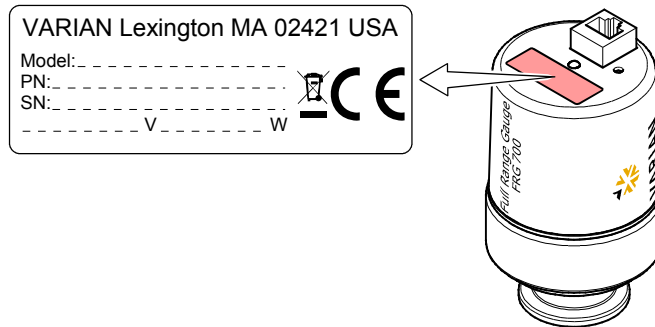

Validity

This document applies to products with part numbers:

FRG700KF25 (DN 25 ISO-KF)
FRG700CF35 (DN 40 CF-F)

The part number (PN) can be taken from the product nameplate.

If not indicated otherwise in the legends, the illustrations in this document correspond to the gauge with vacuum connection DN 25 ISO-KF. They apply to the gauge with other vacuum connection by analogy.

We reserve the right to make technical changes without prior notice.

All dimensions in mm.

Intended Use

The Inverted Magnetron Pirani Gauge FRG-700 has been designed for vacuum measurement in the pressure range of 5×10^{-9} ... 1000 mbar.

The Inverted Magnetron Pirani Gauge must not be used for measuring flammable or combustible gases which react in air.

The gauge can be operated in connection with a VARIAN FRG Control Unit, a VARIAN Turbo AG Rack Controller, or with another controller.

Functional Principle

Over the whole measuring range, the measuring signal is output as a logarithm of the pressure.

The gauge consists of two separate measurement systems (Pirani and cold cathode system) the signals of which are combined in such a way that one measurement signal is output. The Pirani measurement circuit is always on.

Contents

Warranty	3
Warranty Replacement and Adjustment	3
Product Identification	4
Validity	4
Intended Use	4
Functional Principle	4
1 Safety	6
1.1 Symbols Used	6
1.2 Personnel Qualifications	6
1.3 General Safety Instructions	6
2 Technical Data	7
3 Installation	10
3.1 Vacuum Connection	10
3.1.1 Removing the Magnet Unit (Only for Gauges With CF Flanges)	12
3.2 Electrical Connection	13
3.2.1 Use With an VARIAN Controller	13
3.2.2 Use With Another Control Device	13
4 Operation	14
4.1 Measurement Principle, Measuring Behavior	14
5 Deinstallation	16
6 Maintenance	17
6.1 Adjusting the Gauge	17
6.2 Cleaning and Replacing Parts	19
6.2.1 Disassembling	19
6.2.2 Cleaning	20
6.2.3 Reassembling	21
6.3 Troubleshooting	23
7 Spare Parts	24
8 Returning the Product	25
9 Disposal	25
Appendix	26
A: Measuring Signal vs. Pressure	26
B: Gas Type Dependence	27

For cross-references within this document, the symbol (→  XY) is used.

1 Safety

1.1 Symbols Used



DANGER

Information on preventing any kind of physical injury.



WARNING

Information on preventing extensive equipment and environmental damage.



Caution

Information on correct handling or use. Disregard can lead to malfunctions or minor equipment damage.



Notice

1.2 Personnel Qualifications



Skilled personnel

All work described in this document may only be carried out by persons who have suitable technical training and the necessary experience or who have been instructed by the end-user of the product.

1.3 General Safety Instructions

- Adhere to the applicable regulations and take the necessary precautions for the process media used.
Consider possible reactions between the materials (→ 7) and the process media.
Consider possible reactions (e.g. explosion) of the process media due to the heat generated by the product.
- Adhere to the applicable regulations and take the necessary precautions for all work you are going to do and consider the safety instructions in this document.
- Before beginning to work, find out whether any vacuum components are contaminated. Adhere to the relevant regulations and take the necessary precautions when handling contaminated parts.



DANGER



DANGER: magnetic fields





Strong magnetic fields can disturb electronic devices like heart pacemakers or impair their function.



Maintain a safety distance of ≥ 10 cm between the magnet and the heart pacemaker or prevent the influence of strong magnetic fields by antimagnetic shielding.

Communicate the safety instructions to all other users.

2 Technical Data

Measuring range (air, N ₂)	5×10 ⁻⁹ ... 1000 mbar
Accuracy (N ₂)	≈±30% in the range 1×10 ⁻⁸ ... 100 mbar
Reproducibility	≈±5% in the range 1×10 ⁻⁸ ... 100 mbar
Gas type dependence	→ Appendix B
Output signal (measuring signal)	
Voltage range	0 ... +10.5 V
Measuring range	1.82 ... 8.6 V
Voltage vs. pressure	logarithmic, 0.6 V / decade (→ Appendix)
Error signal	<0.5 V no supply >9.5 V Pirani measurement element defective (filament rupture)
Output impedance	2×10 Ω
Minimum loaded impedance	10 kΩ, short-circuit proof
Response time (pressure dependent)	
p > 10 ⁻⁶ mbar	<10 ms
p = 10 ⁻⁸ mbar	≈1000 ms
Gauge identification	85 kΩ referenced to supply common
Status	Pin 6
p > 10 ⁻² mbar Pirani-only mode	 Low = 0 V
p < 10 ⁻² mbar Cold cathode not ignited Pirani-only mode	 Low = 0 V
p < 10 ⁻² mbar Cold cathode ignited Combined Pirani / cold cathode mode	 High = 15 ... 30 VDC
Lamp	High voltage on (LED on)
Supply	
 DANGER	
 The gauge may only be connected to power supplies, instruments or control devices that conform to the requirements of a grounded extra-low voltage (SELV-E according to EN 61010). The connection to the gauge has to be fused ¹⁾ .	
Supply voltage at the gauge	15.0 ... 30.0 VDC (ripple ≤ 1 V _{pp})
Power consumption	≤2 W
Fuse ¹⁾	≤1 AT
The minimum voltage of the power supply must be increased proportionally to the length of the sensor cable.	
Voltage at the supply unit with maximum line length	16.0 ... 30.0 VDC (ripple ≤ 1 V _{pp})

¹⁾ VARIAN controller fulfill these requirements.

FRG-700 Inverted Magnetron Pirani Gauge

Adjustment	
<HV> potentiometer	at $<10^{-4}$ mbar
<ATM> potentiometer	at atmospheric pressure
Electrical connection	FCC68 female, 8 poles
Sensor cable	8 conductors plus shielding
Line length	≤ 50 m (8x0.14 mm ²)
Operating voltage	≤ 3.3 kV
Operating current	≤ 500 μ A
Grounding concept	→ ("Electrical Connection")
Vacuum connection-signal common	connected via 10 k Ω (max. voltage differential with respect to safety ± 50 V with respect to accuracy ± 10 V)
Supply common-signal common	conducted separately
Materials exposed to vacuum	
Vacuum connection	stainless steel
Measuring chamber	stainless steel
Feedthrough	ceramic
Internal seals	FPM 75
Anode	Mo
Ignition aid	stainless steel
Pirani measuring tube	Ni, Au
Pirani filament	W
Mounting orientation	any
Internal volume	≈ 20 cm ³
Pressure	≤ 10 bar (absolute) limited to inert gases
Temperatures	
Operation	+5 ... +55 °C
Bakeout	+150 °C (without magnetic shielding and electronics unit)
Pirani filament	+120 °C
Storage	-40 °C ... +65 °C
Relative humidity	$\leq 80\%$ at temperatures up to +31 °C decreasing to 50% at +40 °C
Use	indoors only altitude up to 2000 m
Protection category	IP 40

FRG-700 Inverted Magnetron Pirani Gauge

Dimensions [mm]

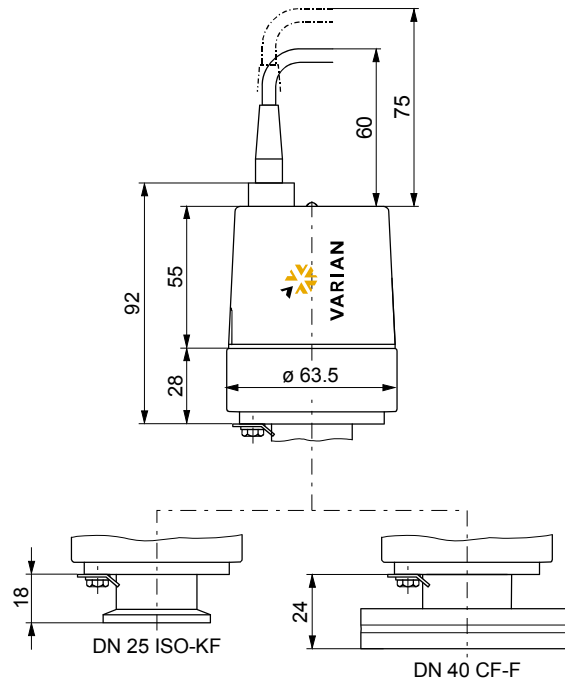

Weight

FRG700KF25

≈ 700 g

FRG700CF35

≈ 980 g

3 Installation

3.1 Vacuum Connection



DANGER

DANGER: overpressure in the vacuum system >1 bar
Injury caused by released parts and harm caused by escaping process gases can result if clamps are opened while the vacuum system is pressurized.

Do not open any clamps while the vacuum system is pressurized. Use the type of clamps which are suited to overpressure.



DANGER

DANGER: overpressure in the vacuum system >2.5 bar
KF flange connections with elastomer seals (e.g. O-rings) cannot withstand such pressures. Process media can thus leak and possibly damage your health.

Use O-rings provided with an outer centering ring.



DANGER

DANGER: protective ground
Products that are not professionally connected to ground can be extremely hazardous in the event of a fault.

The gauge must be electrically connected to the grounded vacuum chamber. The connection must conform to the requirements of protective connection according to EN 61010:

- CF connections fulfill this requirement.
- For gauges with KF connections, use a conductive metallic clamping ring.



Caution

Caution: vacuum component

Dirt and damages impair the function of the vacuum component.

When handling vacuum components, take appropriate measures to ensure cleanliness and prevent damages.



Caution

Caution: dirt sensitive area

Touching the product or parts thereof with bare hands increases the desorption rate.

Always wear clean, lint-free gloves and use clean tools when working in this area.



WARNING

WARNING: electric arcing

Helium may cause electric arcing with detrimental effects on the electronics of the product.

Before performing any tightness tests put the product out of operation and remove the electronics unit.

FRG-700 Inverted Magnetron Pirani Gauge



The gauge may be mounted in any orientation. To keep condensates and particles from getting into the measuring chamber preferably choose a horizontal to upright position and possibly use a seal with a centering ring and filter.



If adjustment should be possible after the gauge has been installed, be sure to install it so that the <HV> and <ATM> trimmer potentiometers can be accessed with a screw driver (→ 17).



When making a CF flange connection, it may be advantageous to temporarily remove the electronics and the magnet unit (→ 12).

Procedure

Remove the protective lid and connect the product to the vacuum system.

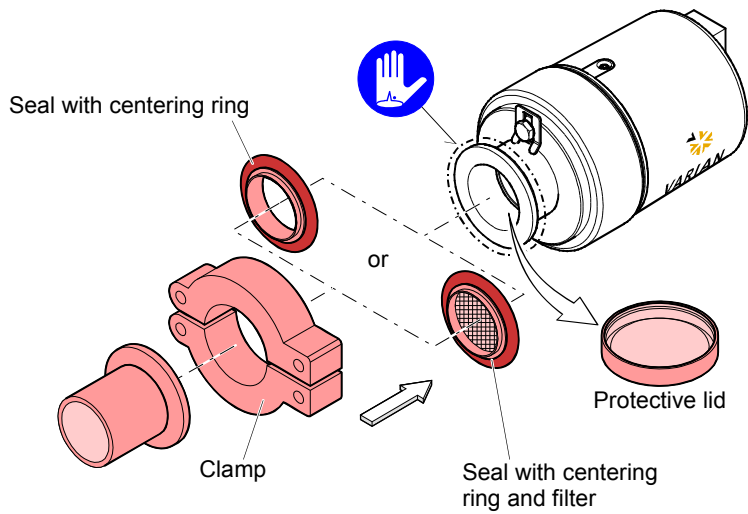

Keep the protective lid.

3.1.1 Removing the Magnet Unit (Only for Gauges With CF Flanges)

Tools required

- Allen wrench AF 1.5
- Open-end wrench AF 7

Procedure

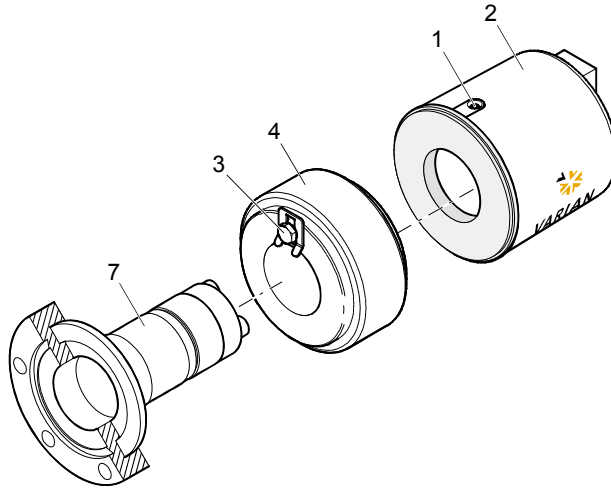

- Unfasten the hexagon socket set screw (1) on the electronics unit (2).
- Remove the electronics unit **without twisting it**.
- Unfasten the hexagon head screw (3) on the magnet unit (4) and remove the magnet unit.



The magnetic force and the tendency to tilt make it difficult to separate the magnet unit and the measuring chamber (7).

- Make the flange connection between the gauge and the vacuum system.
- Remount the magnet unit and lock it with the hexagon head screw (3).
- Carefully mount the electronics unit (2). (Make sure the pin of the Pirani element is properly plugged into the corresponding hole of the electronics unit.)
- Push the electronics unit up to the mechanical stop and lock it with the hexagon socket set screw (1).

3.2 Electrical Connection

Precondition

Make sure the vacuum connection is properly made (→ 10).

3.2.1 Use With an VARIAN Controller

Connect the sensor cable to the gauge and the controller.

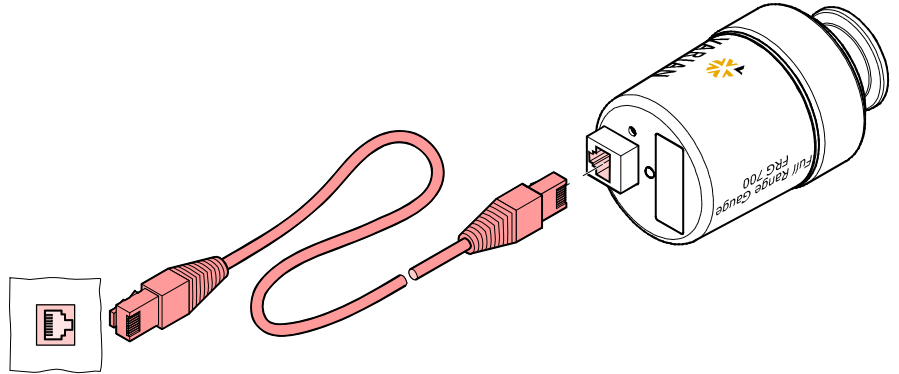

3.2.2 Use With Another Control Device

1 Make a sensor cable according to the diagram.

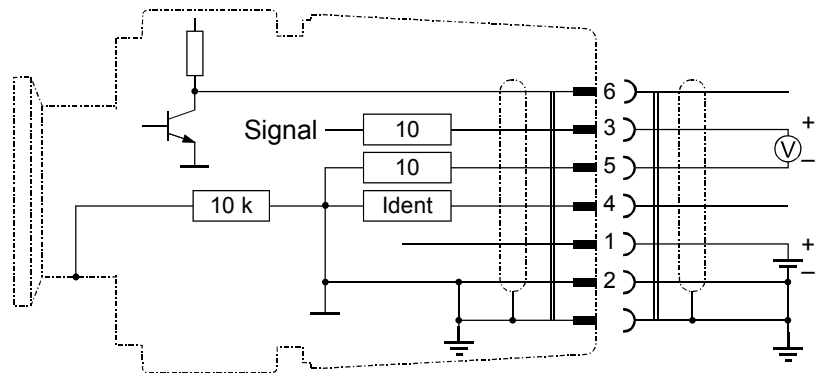

Electrical connection

- Pin 1 Supply (15 ... 30 VDC)
- Pin 2 Supply common
- Pin 3 Signal output
(measuring signal)
- Pin 4 Identification
- Pin 5 Signal common
- Pin 6 Status
- Pin 7, 8 n.c.

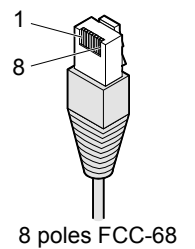

2 Connect the sensor cable to the gauge and the controller.

4 Operation

As soon as the required supply voltage is applied, the measuring signal is available between pins 3 and 5. (→ Appendix for the relationship between the measuring signal and the pressure).

Allow for a stabilizing time of approx. 10 min. Once the gauge has been switched on, permanently leave it on irrespective of the pressure.

4.1 Measurement Principle, Measuring Behavior

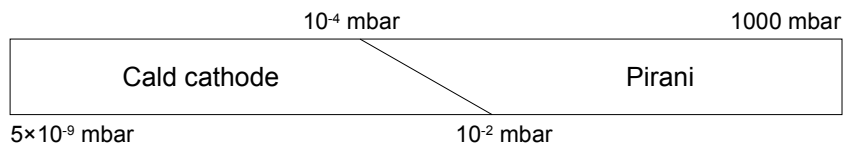

The gauge consists of two separate measuring systems (Pirani and cold cathode system according to the inverted magnetron principle). They are combined in such a way that for the user, they behave like one measuring system.

The optimum measuring configuration for the particular pressure range, in which measurement is performed, is used:



- The Pirani measuring circuit is always on
- The cold cathode measuring circuit is controlled by the Pirani circuit and is activated only at pressures $< 1 \times 10^{-2}$ mbar

The identification output (pin 6) indicates the current status of the gauge:

Pressure	Lamp on the gauge	Operating mode	Pin 6
$p > 1 \times 10^{-2}$ mbar		Pirani-only mode	Low = 0 V
$p < 1 \times 10^{-2}$ mbar		Cold cathode not ignited Pirani-only mode	Low = 0 V
$p < 1 \times 10^{-2}$ mbar		Cold cathode ignited Combined Pirani / cold cathode mode	High = 15 ... 30 VDC

As long as the cold cathode measuring circuit has not ignited, the measuring value of the Pirani is output as measuring signal (if $p < 5 \times 10^{-4}$ mbar, "Pirani underrange" is displayed).

Gas type dependence

The measuring signal depends on the type of gas being measured. The curves are accurate for dry air, O₂, CO and N₂. They can be mathematically converted for other gases (→ Appendix B).

If you are using an VARIAN controller, you can enter a calibration factor to correct the pressure reading (→  of that controller).

Ignition delay

When cold cathode measuring systems are activated, an ignition delay occurs. The delay time increases at low pressures and is typically:

10^{-5} mbar	≈ 1 second
10^{-7} mbar	≈ 20 seconds
5×10^{-9} mbar	≈ 2 minutes

As long as the cold cathode measuring circuit has not yet ignited, the measured value of the Pirani is output as measuring signal ("Pirani underrange" is displayed for pressures $<5 \times 10^{-4}$ mbar). The identification output (pin 6, low) indicates the Pirani-only mode.



If the gauge is activated at a pressure $p < 3 \times 10^{-9}$, the gauge cannot recognize whether the cold cathode system has ignited. It indicates "Pirani underrange".



Once flanged on, permanently leave the gauge in the operating mode irrespective of the pressure range. Like this, the ignition delay of the cold cathode measuring circuit is always negligible (<1 s), and thermal stabilizing effects are minimized.

Contamination



Gauge failures due to contamination, as well as expendable parts (filament), are not covered by the warranty.

Gauge contamination is influenced by the process media used as well as by any present or new contaminants and their respective partial pressures. Continuous operation in the range of 10^{-4} mbar ... 10^{-2} mbar can cause severe contamination as well as reduced up-time and maintenance cycles. With constantly low pressures ($p < 1 \times 10^{-6}$ mbar), the gauge can be operated for more than one year without cleaning (cleaning the gauge → 19).

Contamination of the gauge generally causes a deviation of the measured values:

- In the high pressure range (1×10^{-3} mbar ... 0.1 mbar), the pressure reading is too high (contamination of the Pirani element). Readjustment of the Pirani measuring system → 17.
- In the low pressure range ($p < 1 \times 10^{-3}$ mbar), the pressure reading is usually too low (contamination of the cold cathode system). In case of severe contamination, instabilities can occur (layers of the measuring chamber peel off). Contamination due to insulation layers can even lead to a complete failure of the discharge ("Underrange" is displayed).

Contamination can to a certain extent be reduced by:

- geometric protection measures (e.g. screenings, elbows) for particles that spread rectilinearly
- mounting the flange of the gauge at a place where the partial pressure of the pollutants is particularly low.

Special precautions are required for vapors deposited under plasma (of the cold cathode measuring system). It may even be necessary to temporarily switch of the gauge while such vapors occur.

5 Deinstallation

DANGER



DANGER: contaminated parts

Contaminated parts can be detrimental to health and environment. Before beginning to work, find out whether any parts are contaminated. Adhere to the relevant regulations and take the necessary precautions when handling contaminated parts.



Caution



Caution: vacuum component

Dirt and damages impair the function of the vacuum component. When handling vacuum components, take appropriate measures to ensure cleanliness and prevent damages.



Caution



Caution: dirt sensitive area

Touching the product or parts thereof with bare hands increases the desorption rate.

Always wear clean, lint-free gloves and use clean tools when working in this area.

Procedure

- 1** Vent the vacuum system.
- 2** Put the gauge out of operation and unplug the sensor cable.
- 3** Remove the gauge from the vacuum system and install the protective lid.



When deinstalling the CF flange connection, it may be advantageous to temporarily remove the magnet unit (→ 12).

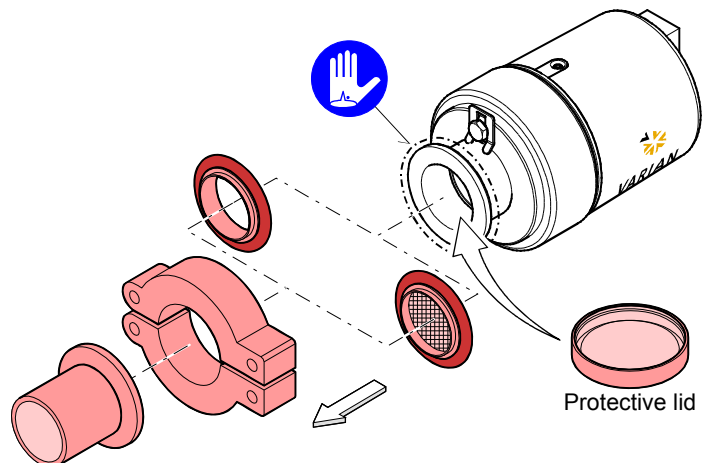

6 Maintenance



Gauge failures due to contamination, as well as expendable parts (filament), are not covered by the warranty.

DANGER



DANGER: contaminated parts

Contaminated parts can be detrimental to health and environment. Before beginning to work, find out whether any parts are contaminated. Adhere to the relevant regulations and take the necessary precautions when handling contaminated parts.

Caution



Caution: vacuum component

Dirt and damages impair the function of the vacuum component.

When handling vacuum components, take appropriate measures to ensure cleanliness and prevent damages.

Caution



Caution: dirt sensitive area

Touching the product or parts thereof with bare hands increases the desorption rate.

Always wear clean, lint-free gloves and use clean tools when working in this area.

6.1 Adjusting the Gauge

The gauge is factory-calibrated. If used under different climatic conditions, through extreme temperatures, aging or contamination, and after exchanging the sensor, the characteristic curve can be offset and readjustment may become necessary.

The cold cathode measuring circuit, which is dominant for low pressures ($<1 \times 10^{-3}$ mbar), is factory-calibrated and cannot be adjusted. By way of contrast, the Pirani measuring circuit can be adjusted. Any adjustment has a negligible effect on the pressure range between approx. 10^{-2} mbar and 10^2 mbar.

Tools required

- Screw driver 1.5 mm
- Cylindrical pin $\varnothing \approx 3$ mm

Procedure

- 1** If you are using a seal with centering ring and filter, check that they are clean or replace them if necessary (\rightarrow [16](#)).
- 2** Put the gauge into operation (if possible, in the position, in which it will be used later on).
- 3** Evacuate the vacuum system to $p \ll 10^{-4}$ mbar, and then wait 10 minutes.
- 4** Turn the nameplate counter-clockwise until the mechanical stop is reached.

5

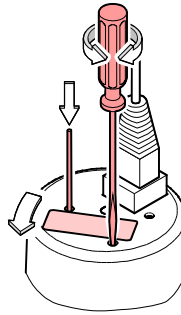

While depressing the pin with the cylindrical pin, adjust the <HV> potentiometer ...

... to 4.20 V

or

... to 5×10^{-4} mbar.

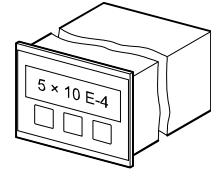
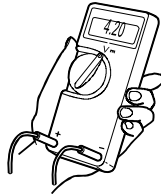

After that, turn the potentiometer counter-clockwise by 1/3 of a turn.

6

Vent the gauge with air or nitrogen to atmospheric pressure, and wait at least 10 minutes.

7

Turn the nameplate clockwise until the mechanical stop is reached.

8

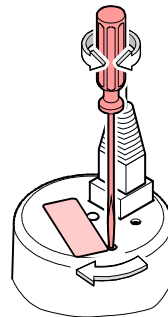

Using the 1.5 mm screwdriver, adjust the <ATM> potentiometer ...

... to 8.60 V

or

... to 1×10^3 mbar.

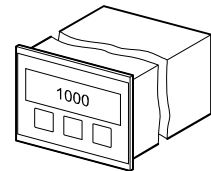
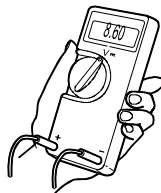

9

Turn the nameplate back to its original position (it catches).

- 4 Unfasten the hexagon head screw (3) on the magnet unit (4) and remove the magnet unit.



The magnetic force and the tendency to tilt make it difficult to separate the magnet unit and the measuring chamber (7).

- 5 Remove the circlip (5) and the polarity insert (6) from the measuring chamber

- 6 Remove the three hexagon socket screws (8) incl. lock washers (8a) on the back of the measuring chamber.

- 7 Carefully remove the following parts in this order (without exerting stress on the Pirani element (13)): pressure piece (9), complete anode (10), FPM seal (11) incl. support ring (12), Pirani element (13) incl. FPM seal (13a).

The parts can now be cleaned or replaced individually.

6.2.2 Cleaning

Cleaning the measuring chamber and the polarity insert

- 1 Using a polishing cloth rub the inside walls of the measuring chamber and the polarity insert to a bright finish.



The sealing surfaces must only be worked concentrically.

- 2 Rinse the measuring chamber and the polarity insert with cleaning alcohol.
- 3 Allow both to dry.

Cleaning or replacing the anode

- 1 Remove the used ignition aid (10a) with tweezers.

- 2 Using a polishing cloth rub the anode pin to a bright finish.



Do not bend the anode. Do not carry out mechanical work on the ceramic part.

- 3 Rinse the anode with cleaning alcohol.

- 4 Allow the anode to dry.

- 5 Insert a new ignition aid (10a) into the mounting tool.

- 6 Carefully press the anode (clean or new) centered and parallel to the tool axis into the ignition aid and insert it to a depth of approx. 15 mm. The final positioning is established after the anode is installed.

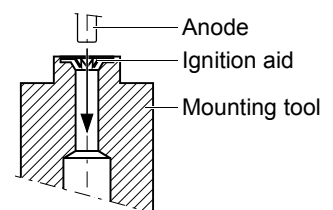

Cleaning the Pirani element

- ➊ Remove the FPM seal (13a) from the Pirani element (13).
- ➋ Fill the Pirani measuring tube with cleaning alcohol and let it work.
- ➌ Pour the alcohol out of the tube.
- ➍ Dry the tube (e.g. with a blow dryer <math><150\text{ }^\circ\text{C}</math>).
- ➎ Slide a new FPM seal over the Pirani element and insert it into the corresponding groove.
- ➏ Reinstall the Pirani element (→ 21).

Replacing the Pirani element



If it is severely contaminated or defective.

- ➊ Slide a new FPM seal (13a) over the Pirani element (13) and insert it into the corresponding groove.
- ➋ Mount the Pirani element (→ 21).

6.2.3 Reassembling



(→ figure 19)

- ➊ Insert the FPM seal (11) with the support ring (12) centered into the measuring chamber (7). The sealing surface, seal, and ceramic part must be clean.
- ➋ Carefully insert the anode (10) incl. ignition aid (10a) into the measuring chamber.
- ➌ Insert the Pirani element (13) with the FPM seal (13a) slid over it into the corresponding bore hole.
- ➍ Carefully place the pressure piece (9) on the measuring chamber and tighten them with the three hexagon socket screws (8) incl. lock washers (8a) uniformly until the stop position is reached.
- ➎ Position the ignition aid (10a) by pushing the mounting tool over the anode pin until the mechanical stop is reached.
- ➏ Blow the particles in the measuring chamber with dry nitrogen (be careful to hold the measuring chamber with the flange pointing downwards).
- ➐ Slide the polarity insert (6) into the measuring chamber until the mechanical stop is reached.
- ➑ Place the circlip (5) snugly fitting on the polarity insert.



Visually check that the anode pin is centered over the middle hole of the polarity insert (max. eccentricity = 0.5 mm).

- 9 If possible perform a leak test (leak rate $<10^{-9}$ mbar l/s).

	 WARNING
<p>WARNING: electric arcing Helium may cause electric arcing with detrimental effects on the electronics of the product. Before performing any tightness tests put the product out of operation and remove the electronics unit.</p>	

- 10 Mount the magnet unit (4) and lock it with the screw (3).
- 11 Carefully mount the electronics unit (2). (Make sure the pin of the Pirani element is properly plugged into the corresponding hole of the electronics unit.)
- 12 Push the electronics unit up to the mechanical stop and lock it with the hexagon socket set screw (1).
- 13 Adjust the gauge (→ 17).

6.3 Troubleshooting

Problem	Possible cause	Remedy
Measuring signal continually < 0.5 V "Error low".	No supply voltage.	Turn on the power supply.
Measuring signal continually > 9.5 V "Error high".	Pirani measurement element defective (filament rupture).	Replace the Pirani element (→ 19).
	Electronics unit not correctly mounted.	Mount the electronics unit correctly (→ 19).
The green lamp is ON and the identification indicates Pirani-only mode (measuring signal continually > 4.0 V) "Pirani underrange".	The cold cathode discharge has not ignited.	Wait until the gas discharge ignites (in case of contamination with insulation layers, the cold cathode may completely fail to ignite). (Cleaning → 19).
	The FRG has only been activated with $p < 3 \times 10^{-9}$ mbar.	Slightly increase the pressure.
Measuring signal continually > 5 V or display > 10^{-3} mbar although vacuum pressure is OK.	Pirani measurement circuit not adjusted, e.g. due to severe contamination.	Readjust the Pirani measurement circuit (→ 17). If adjustment is impossible, replace the Pirani element.
	Measurement of heavy gases.	Convert with the corresponding formula (→ 27).
	Severe outgassing in the cold cathode measuring chamber.	Clean the measuring chamber.
Measuring signal unstable.	Gauge contaminated.	Clean the gauge (→ 19).

7 Spare Parts

When ordering spare parts, always mention:

- all information on the product nameplate
- description and ordering number according to the spare parts list

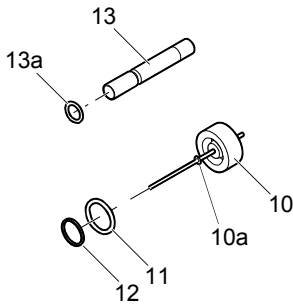

Pos.	Description	Ordering number
	Maintenance kit, consisting of:	FRG700MAINT
12	1× support ring	
13a	1× O-ring FPM $\varnothing 3.69 \times 1.78$	
11	1× O-ring FPM $\varnothing 10.82 \times 1.78$	
10a	3× ignition aid	
	Repair kit, consisting of:	FRG700REPR
13	1× Pirani element	
12	1× support ring	
13a	1× O-ring FPM $\varnothing 3.69 \times 1.78$	
11	1× O-ring FPM $\varnothing 10.82 \times 1.78$	
10a	3× ignition aid	
10	1× anode, complete	

8 Returning the Product



WARNING

WARNING: forwarding contaminated products

Contaminated products (e.g. radioactive, toxic, caustic or biological hazard) can be detrimental to health and environment.

Products returned to VARIAN should preferably be free of harmful substances. Adhere to the forwarding regulations of all involved countries and forwarding companies and enclose a duly completed declaration of contamination.

Products that are not clearly declared as "free of harmful substances" are decontaminated at the expense of the customer.

Products not accompanied by a duly completed declaration of contamination are returned to the sender at his own expense.

9 Disposal



DANGER

DANGER: contaminated parts

Contaminated parts can be detrimental to health and environment.

Before beginning to work, find out whether any parts are contaminated. Adhere to the relevant regulations and take the necessary precautions when handling contaminated parts.



WARNING

WARNING: substances detrimental to the environment

Products or parts thereof (mechanical and electric components, operating fluids etc.) can be detrimental to the environment.

Dispose of such substances in accordance with the relevant local regulations.

Separating the components

After disassembling the product, separate its components according to the following criteria:

Contaminated components

Contaminated components (radioactive, toxic, caustic or biological hazard etc.) must be decontaminated in accordance with the relevant national regulations, separated according to their materials, and disposed of.

Other components

Such components must be separated according to their materials and recycled.

Appendix

A: Measuring Signal vs. Pressure

Conversion formulae

$$p = 10^{1.667U-d} \Leftrightarrow U = c + 0.6 \log_{10} p$$

p	U	c	d
[mbar]	[V]	6.8	11.33
[Torr]	[V]	6.875	11.46
[Pa]	[V]	5.6	9.333

where p pressure valid in the range 5×10^{-9} mbar < p < 1000 mbar
 U measuring signal 3.8×10^{-9} Torr < p < 750 Torr
 c, d constant (pressure unit dependent) 5×10^{-7} Pa < p < 1×10^5 pa

Conversion curves

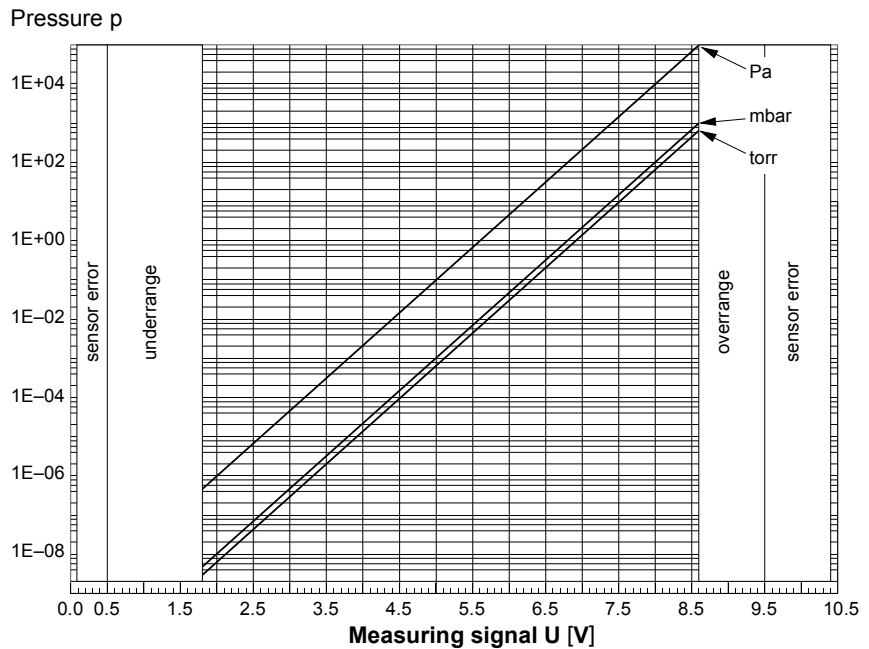

Conversion table

Meas. signal U [V]	Pressure p [mbar]	Pressure p [Torr]	Pressure p [Pa]
<0.5	Sensor error		
0.5 ... 1.82	Underrange		
1.82	5.0×10^{-9}	3.8×10^{-9}	5.0×10^{-7}
2.0	1.0×10^{-8}	7.5×10^{-9}	1.0×10^{-6}
2.6	1.0×10^{-7}	7.5×10^{-8}	1.0×10^{-5}
3.2	1.0×10^{-6}	7.5×10^{-7}	1.0×10^{-4}
3.8	1.0×10^{-5}	7.5×10^{-6}	1.0×10^{-3}
4.4	1.0×10^{-4}	7.5×10^{-5}	1.0×10^{-2}
5.0	1.0×10^{-3}	7.5×10^{-4}	0.1
5.6	1.0×10^{-2}	7.5×10^{-3}	1.0
6.2	0.1	7.5×10^{-4}	10
6.8	1.0	0.75	100
7.4	10	7.5	1000
8.0	100	75	1.0×10^4
8.6	1000	750	1.0×10^5
8.6 ... 9.5	Overrange		
9.5 ... 10.5	Sensor error (Pirani defective)		

B: Gas Type Dependence

Indication range above 10^{-2} mbar

Pressure indicated (gauge calibrated for air).

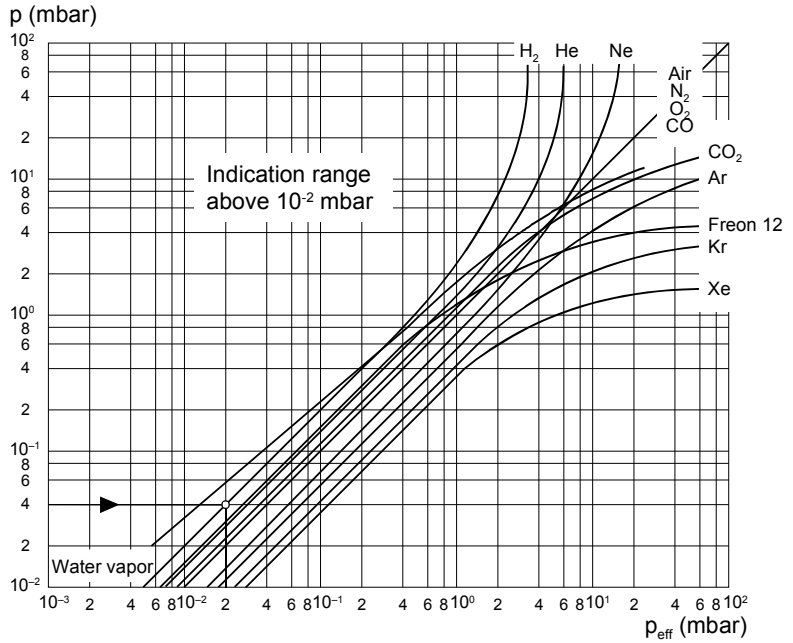

Indication range 10^{-6} ... 0.1 mbar

Pressure indicated (gauge calibrated for air).

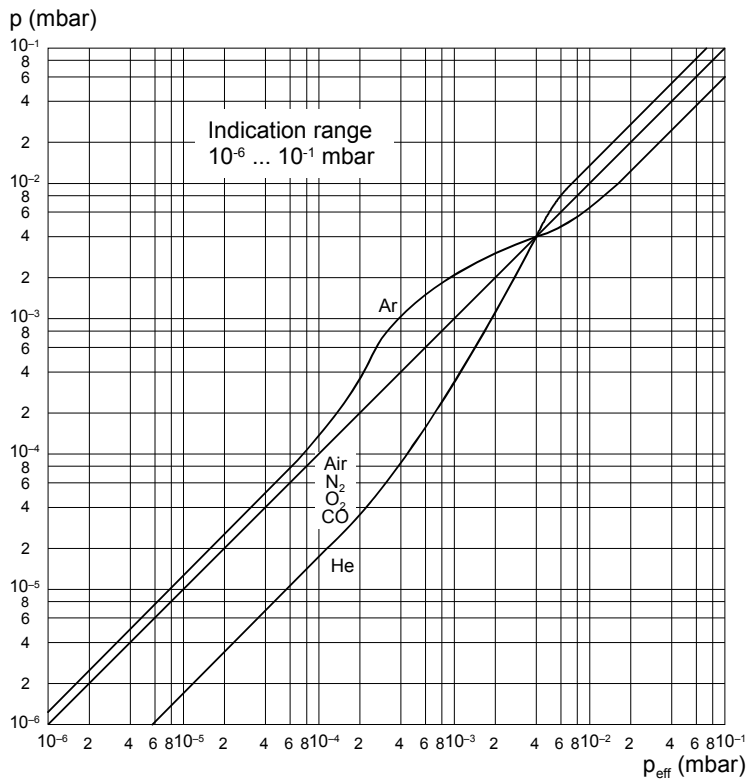

Indication range below
 10^{-5} mbar

In the range below 10^{-5} mbar, the pressure indication is linear. For gases other than air, the pressure can be determined by means of a simple conversion formula:

$$p_{\text{eff}} = K \times \text{pressure indicated}$$

where	gas type	K
	air (O ₂ , CO, N ₂)	1.0
	Xe	0.4
	Kr	0.5
	Ar	0.8
	H ₂	2.4
	Ne	4.1
	He	5.9

These conversion factors are average values.



A mixture of gases and vapors is often involved. In this case, accurate determination is only possible with a partial pressure measurement instrument, e.g. a quadrupole mass spectrometer.

Notes

Original: English



t qna48e1

Varian Vacuum Technologies
121 Hartwell Avenue
Lexington, MA, 02421 USA
Tel: (781) 861 7200
Fax: (781) 861 5437
custserv@varianinc.com

www.varianinc.com