



The next generation 15 m³/h Scroll Pump,
designed for quiet and low vibration operation

AGILENT IDP-15 DRY SCROLL PUMP **CLEAN. QUIET. RELIABLE.**

The Measure of Confidence



Agilent Technologies

The state-of-the-art in dry scroll pump technology



The Agilent IDP-15 Scroll Pump is a high performance dry primary vacuum pump, providing rapid pump-down at 15.4 m³/hour (60 Hz). With a single-sided scroll design it offers fast, easy yearly maintenance and low cost of ownership. It is hermetic, with the motor and all bearings completely isolated from the vacuum path and protected from process gases for extended life.

The IDP-15 is exceptionally quiet (<50db) and vibration-free, and is ideal for use in Analytical Instrument and Research applications, and many industrial applications as well.

Applications

The IDP-15 Dry Scroll Pump is the ideal solution for vacuum users in most clean applications, for backing a turbo pump, and for loadlock applications in general. Key target applications include:



Academic and Research

- Government Research Labs
- University Labs
- High Energy Physics/Beam Lines



Industrial

- Glovebox
- Crystal Pulling
- LED/Light Manufacturing
- Freeze Drying
- Gel Drying
- Sample Preparation



Instrumentation

- Cryogenics
- Electron Microscope
- Helium Recirculation
- Leak Detectors
- Mass Spectrometry
- Ion Implant
- Leak Detection
- Surface Science Instruments

Features and Benefits

IDP-15 Feature	Advantage	Benefits
Isolated bearings/motor	No risk of oil or grease back streaming from the pump	Longer Service Interval with condensable vapor applications
Single Sided Scroll Design	Easier, quicker basic service	
Solid Tip Seals	Longer Tip Seal Life in most applications	Longer Service Interval with condensable vapor applications
Very low noise and vibration	Appropriate for use in laboratory settings	Required in applications such as Mass Spec and Microscopy
Hermetic Design	Necessary for use in helium and other pure gas applications	No risk of non-process gases entering the vacuum path
Optional Integral Isolation Valve	Fast acting isolation valve at relatively low cost	Valve is built into pump module and adds no height to the inlet of the pump
IEC Power Cord Module	All pumps use standard IEC power cords	Power cord not hard-wired to the motor

Understanding Scroll Pump Technology



Gas enters scroll set



Gas is displaced and...



...compressed toward center hub



Gas exhausted at center hub

IDP Pumps create vacuum using a simple dual scroll mechanism in which one of the nested scrolls orbits about the other, creating moving zones of captured gas. Gas enters the scroll set at the perimeter and is displaced and compressed toward the center hub where it is exhausted.

The uncomplicated dual scroll design offers many benefits including lower noise and vibration levels, simple and infrequent maintenance requirements, plus the elimination of catastrophic failure modes.

IDP-15 Key Design Elements

A state-of-the-art Vacuum Pump

Vacuum in pump,
inlet valve opens

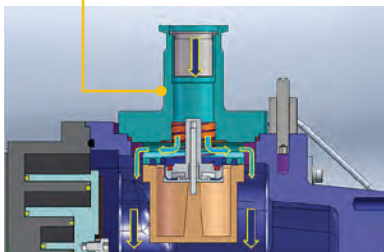

Pump Vents,
inlet valve closes

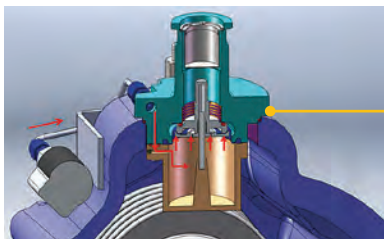

Isolated and Hermetic Design

Motor and Bearings completely isolated from the vacuum path

- Motor and Bearings are not exposed to any process gases or water vapor from the application
- Bearings run at atmospheric pressure

Hermetic Design

- Appropriate for Rare Gas and Helium recirculation applications
- Gas Ballast normally closed
- Closed system from inlet to exhaust
- Each pump is leak checked

Optional Integral Isolation Valve

- The Integral Inlet Isolation Valve is installed inside the module; it adds no height to the pump inlet
- Valve protects against backward migration through the inlet, and sudden venting of customer chamber/instrument
- Spring holds inlet valve normally closed
- Lower pressure in pump causes spring to open
- On power loss, solenoid valve vents pump causing inlet valve to close (20 ms)
- Power is restored, solenoid closes, inside of pump begins evacuating, inlet valve opens (about 10 sec)

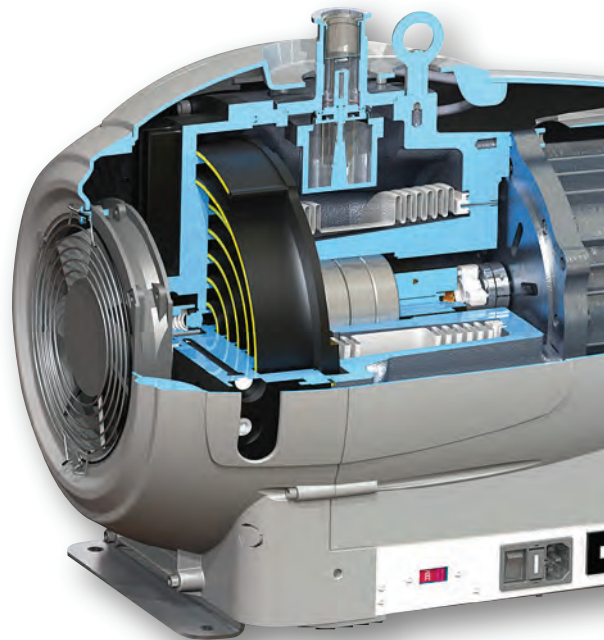

Fixed Speed Motor Supports Global Input Voltages

- Supports Single Phase Operating Voltages:
 - 100V, 50/60 Hz
 - 115V, 60Hz
 - 220-230V, 50/60Hz
- Simple Switch to change between high and low voltage use.

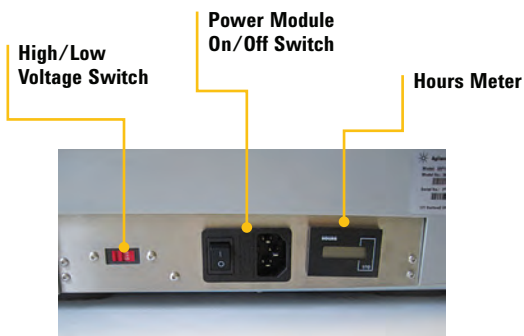

Designed for Quiet Operation

Low noise

- Agilent consulted with noise experts to aid in designing Pump Module to minimize noise
- Three piece outer cowling acts as a built-in noise enclosure
- IDP-15 is specified at 50 dBA \pm 2 dBA, much lower than other scroll pumps available

Outer Cowling acts as Noise Enclosure

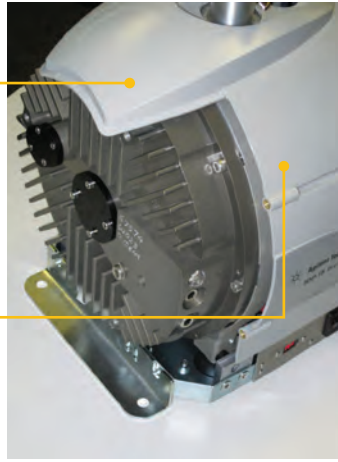

How Quiet is the IDP-15?

Noise	dBA
Chainsaw; Thunder Clap	120
Car Horn (1m); Live Rock Music	110
Lawn Mower; Airplane Take off (1km)	100
Motorcycle (8m away)	90
Freight Train (25m); Food Blender	80
Cars on Freeway; Vacuum Cleaner	70
Air Conditioner (30m); Office Noise	60
Best competing scroll pump	52
Conversation at Home; IDP-15	50
Library	40

Every additional 10 dBA is a doubling of noise

Low Vibration

The IDP-15 is equipped with integral Vibration Isolation feet, which:

- Decouple vibration from motor and scrolls from the mounting brackets
- Dampen vibration of the pump module

Vibration Isolators

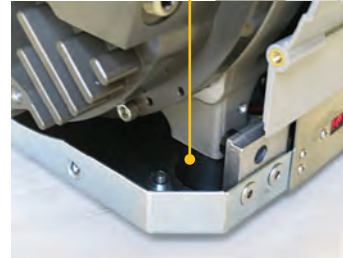
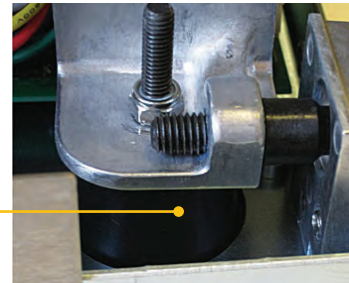

Single Sided Scroll Design

- Only Fixed Scroll needs to be removed to change tip seals
- Very easy basic service, 15 minutes using two tools
- Simple design still achieves a low ultimate pressure of 10 mTorr



Design for Service



IDP-15 Tip Seal Replacement: 15 minutes

Agilent IDP-15 Dry Scroll Pump

Clean. Quiet. Reliable.



Technical Specifications

Peak pumping speed:	60 Hz: 256 L/m, 15.4 m ³ /hr 50 Hz: 214 L/m, 12.8 m ³ /hr
Media:	Not suitable for use with corrosive, explosive or particulate-forming gases
Ultimate pressure:	10 x 10 ⁻³ Torr (13.3 x 10 ⁻³ mbar)
Maximum inlet pressure:	1.0 atmosphere (0 psig)
Maximum outlet pressure:	6.5 psig
Inlet connection:	NW25
Exhaust connection:	NW16
Gas ballast:	1/4" NPTF (two positions)
Water vapor handling per Pneurop 6602:	Gas Ballast Position 1: 20.7 g/hr Gas Ballast Position 2: 235 g/hr
Ambient operating temp.:	5 °C to 45 °C (41 °F to 113 °F)
Storage temperature:	-20 °C to 60 °C (-4 °F to 140 °F)
Motor rating:	0.75 HP (560 W)
Operating voltages:	1ø / 100 VAC, 50/60 Hz 1ø / 115 VAC, 60 Hz 1ø / 220-230 VAC, 50/60 Hz
Motor thermal protection:	Automatic thermal protection
Operating speed:	60 Hz: 1725 RPM, 50 Hz: 1450 RPM
Cooling system:	Air-cooled
Pump weight:	34 kg (75 lbs)
Shipping weight:	45 kg (100 lbs)
Dimensions:	364mm (14.3") h x 333mm (13.1") w x 485mm (19.1") l
Leak rate*	<1 x 10 ⁻⁶ sccs helium
Vibration level at inlet	< 9 mms ⁻¹ rms
Noise level	50 dBA ± 2dBA
Conformance standards	CE, CSA, RoHS

*(with exhaust and gas ballast sealed)

Pumping Speed

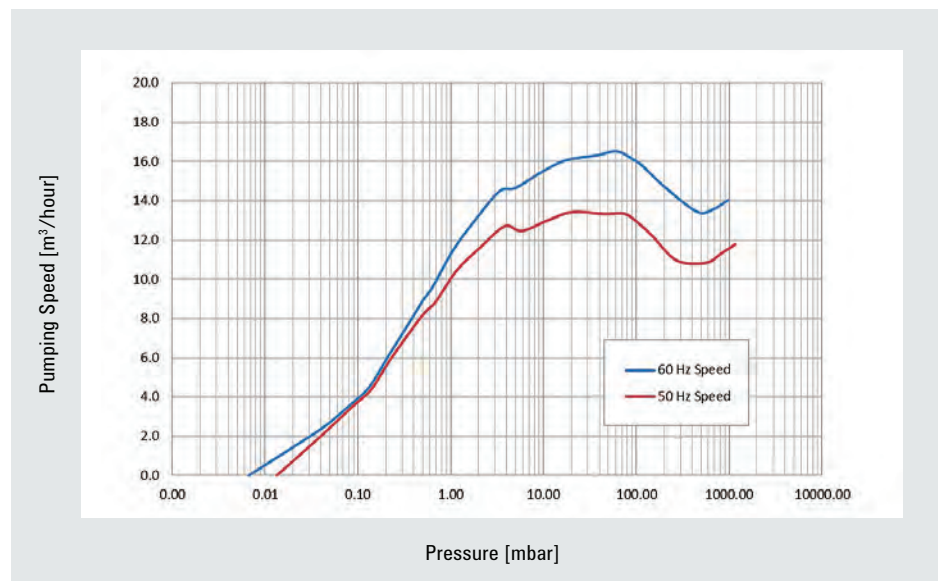

Ordering Information

Pump Part Numbers

X3815-64000	IDP15 Scroll Pump, Std
X3815-64010	IDP15 Scroll Pump, Std w/inlt vlv

Service Part Numbers

X3815-67000	IDP-15 Tip Seal Replacement Kit
-------------	---------------------------------

Spares Part Numbers

X3815-67001	Shipping Box Set, IDP-15
-------------	--------------------------

Accessories:

SCRINTRPNW25	Inlet Trap, NW25, HEPA
EXSLRSH110	Exhaust Silencer Kit, SH110

Line Cords:

656494220	Europe, 10A/220-230V, 2.5 meter
656494225	Denmark, 10A/220-230V, 2.5 meter
656494235	Switzerland, 10A/230V, 2.5 meter
656494250	UK/Ireland, 13A/230V, 2.5 meter
656494245	India, 10A/220-250V, 2.5 meter
656494230	Israel, 10A/220-230V, 2.5 meter
656494240	Japan, 12A/100V, 2.3 meter
656458203	North America, 15A/125V, 2.0 meter
656494255	North America, 10A/230V, 2.5 meter

Outline Drawing

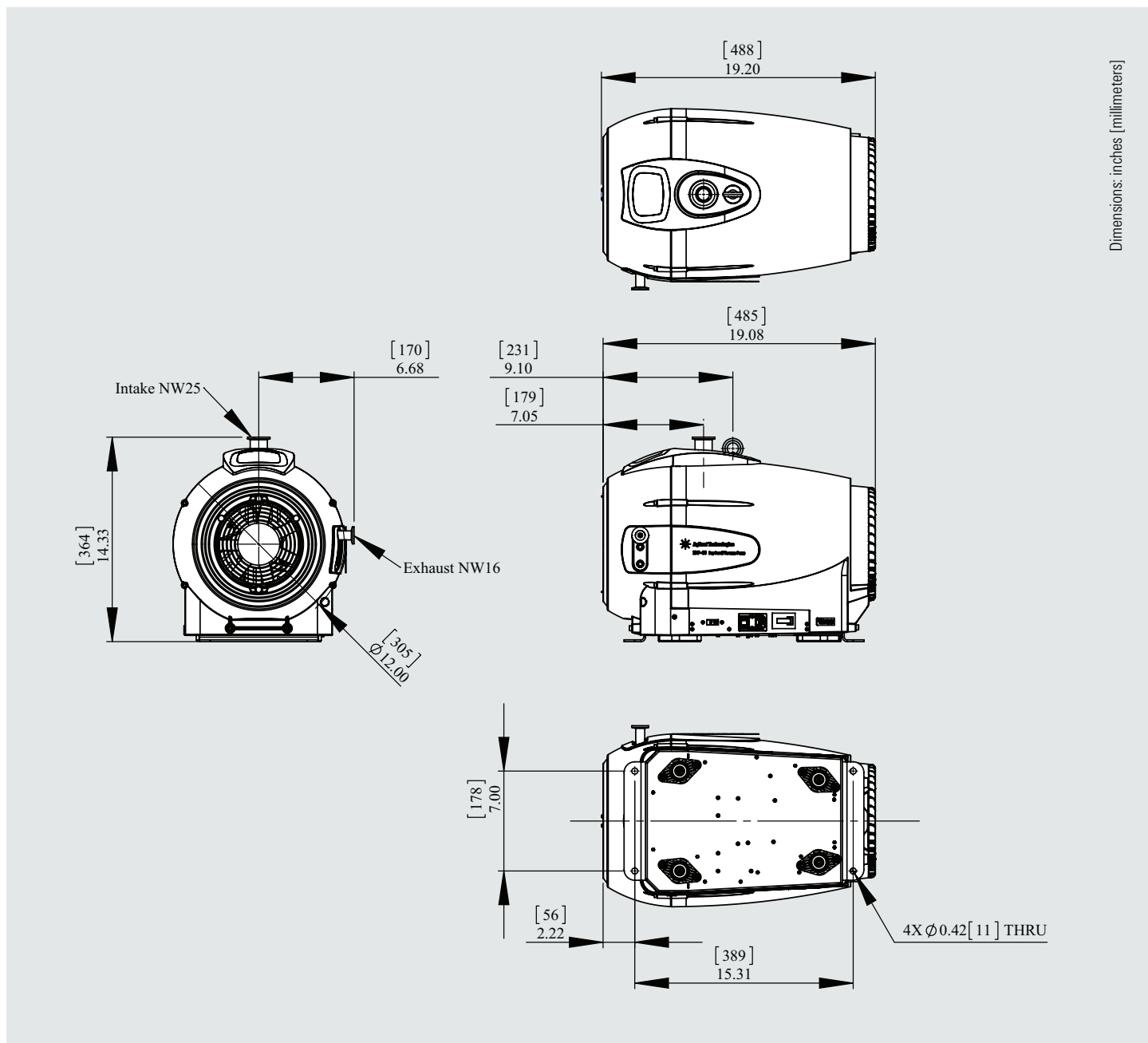

Agilent IDP-15 Dry Scroll Pump

Agilent Technologies

United States

Agilent Technologies
121 Hartwell Avenue,
Lexington MA 02421, USA
Tel: +1 781 861 7200
Fax: +1 781 860 5437
Toll free: +1 800 882 7426
vpl-customerservice@agilent.com

China

Beijing Office

Agilent Technologies (China) Co. Ltd
No.3, Wang Jing Bei Lu, Chao Yang District,
Beijing, 100102, China
Tel: +86 (0)10 64397888
Fax: +86 (0)10 64391318
Toll free: 800 820 3278
vacuum.cnmarketing@agilent.com
vpc-customerservice@agilent.com

Shanghai Office

Agilent Technologies
2F, Building 4, No.690 Bibo Road,
Zhangjiang Hi-Tech Park, Pudong District,
Shanghai, 201203, China
Tel: +86 (0)21 38507688
Fax: +86 (0)21 50278465
Toll free: 800 820 3278

Guangzhou Office

Agilent Technologies
Unit 08, 66/F, Citic Plaza,
233 Tian He Bei Rd
Guangzhou, 510613, China
Tel: +86 (0)20 38113988
Fax: +86 (0)20 86695861
Toll free: 800 820 3278

Shenzhen Office

Agilent Technologies
3/F Dutyfree Business Bldg.,
No.6, 1st Fu Hua Road, Futian CBD,
Shenzhen, 518048
Tel: +86 (0)755 83079588
Fax: +86 (0)755 82763181
Toll free: 800 820 3278

Brazil

Agilent Technologies Brasil
Avenida Marcos Penteado de Ulhoa
Rodrigues, 939 – 6° andar
Castelo Branco Office Park,
Torre Jacarandá - Tamboré
Barueri, Sao Paulo CEP: 06460-040
Toll free: 0800-728-1405

Benelux

Agilent Technologies Netherlands BV
Groenelaan 5, 1186 AA Amstelveen
The Netherlands
Tel: +31 20 547 2000
Fax: +31 20 547 2093

France

Agilent Technologies
Parc Technopolis - Z.A. de Courtaboeuf
3, avenue du Canada - CS 90263
91978 Les Ulis cedex, France
Tel: +33 (0) 1 64 53 61 15
Fax: +33 (0) 1 64 53 50 01
vpf.sales@agilent.com

Germany and Austria

Agilent Technologies
Sales & Services GmbH & Co. KG
Lyoner Str. 20
60 528 Frankfurt am Main, Germany
Tel: +49 69 6773 43 2230
Fax: +49 69 6773 43 2250

India

Agilent Technologies India Pvt. Ltd.
G01, Prime corporate Park, 230/231,
Sahar Rd., Opp. Blue Dart Centre,
Andheri (East), Mumbai, 400 099 India
Tel: +91 22 30648287/8200
Fax: +91 22 30648250
Toll free: 1800 113037

Italy

Agilent Technologies Italia SpA
via F.lli Varian 54
10040 Leini, (Torino), Italy
Tel: +39 011 9979 111
Fax: +39 011 9979 350
Toll free: 00 800 234 234 00
vpt-customerservice@agilent.com

Japan

Agilent Technologies Japan, Ltd.
8th Floor Sumitomo Shibaura Building
4-16-36 Shibaura Minato-ku
Tokyo 108-0023, Japan
Tel: +81 3 5232 1253
Fax: +81 3 5232 1710
Toll free: 0120 655 040
vpj-customerservice@agilent.com

Korea

Agilent Technologies Korea Ltd.
Shinsa 2nd Bldg. 1F, 966-5 Daechi-dong
Kangnam-gu, Seoul, Korea 135-280
Tel: +82 (0)2 2194 9449
Fax: +82 (0)2 3452 3947
Toll free: 080 222 2452
vpk-customerservice@agilent.com

Mexico

Agilent Technologies
Concepcion Beistegui No 109
Col Del Valle, C.P. 03100, Mexico, D.F.
Tel: +52 5 523 9465
Fax: +52 5 523 9472

Singapore

Agilent Technologies Singapore Pte Ltd.
No.1 Yishun Avenue 7, Singapore 768923
Tel: +65 6215 8045
Fax: +65 6754 0574
Toll free: 1 800 2762622
vps-customerservice@agilent.com

Southeast Asia

Agilent Technologies Sales Sdn Bhd
Unit 201, Level 2 uptown 2,
2 Jalan SS21/37, Damansara Uptown
47400 Petaling Jaya, Selangor, Malaysia
Tel: +60 3 7712 6106
Fax: +60 3 6733 8121
Toll free: 1 800 880 805
vps-customerservice@agilent.com

Taiwan

Agilent Technologies Taiwan Limited
20 Kao-Shuang Road Ping-Chen City
Tao-Yuan Hsien,
32450 Taiwan, R.O.C.
Tel: +886 3 4959004
Toll free: 0800 018 768
vpw-customerservice@agilent.com

UK and Ireland

Agilent Technologies UK Ltd.
6 Mead Road, Oxford Industrial Park
Yarnton, Oxford OX5 1QU, UK
Tel: +44 (0) 1865 291570
Fax: +44 (0) 1865 291571



This information is subject to change without notice

© Agilent Technologies, Inc. 2013
Published Aug 31, 2013
VPD-0213EN

Scan the QR code
with your smartphone
for more information



Agilent Technologies