

NOTICE: This document contains references to Varian. Please note that Varian, Inc. is now part of Agilent Technologies. For more information, go to [www.agilent.com/chem](http://www.agilent.com/chem).



# ***XGS-600™ Gauge Controller***

*INSTRUCTION MANUAL*

Manual No. 699908400

Revision B

August 2009

[ideavac.com](http://ideavac.com)  
**Ideal**  
vacuum products  
(505)872-0037  
[ideavac.com](http://ideavac.com)

# XGS-600 Gauge Controller

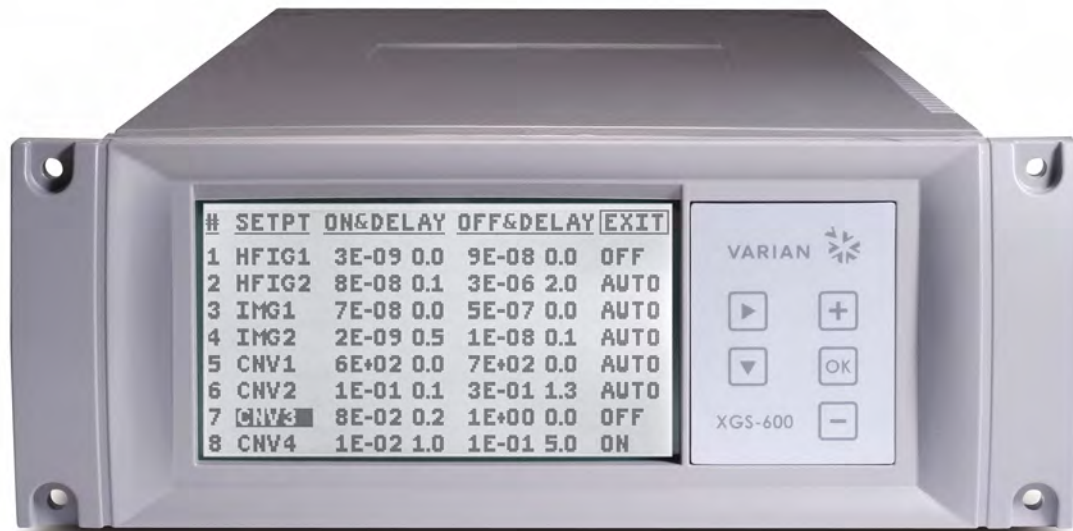

# Warranty

Products manufactured by Seller are warranted against defects in materials and workmanship for twelve (12) months from date of shipment thereof to Customer, and Seller's liability under valid warranty claims is limited, at the option of Seller, to repair, to replace, or refund of an equitable portion of the purchase price of the Product. Items expendable in normal use are not covered by this warranty. All warranty replacement or repair of parts shall be limited to equipment malfunctions which, in the sole opinion of Seller, are due or traceable to defects in original materials or workmanship. All obligations of Seller under this warranty shall cease in the event of abuse, accident, alteration, misuse, or neglect of the equipment. In-warranty repaired or replaced parts are warranted only for the remaining unexpired portion of the original warranty period applicable to the repaired or replaced parts. After expiration of the applicable warranty period, Customer shall be charged at the then current prices for parts, labor, and transportation.

Reasonable care must be used to avoid hazards. Seller expressly disclaims responsibility for loss or damage caused by use of its Products other than in accordance with proper operating procedures.

Except as stated herein, Seller makes no warranty, express or implied (either in fact or by operation of law), statutory or otherwise; and, except as stated herein, Seller shall have no liability under any warranty, express or implied (either in fact or by operation of law), statutory or otherwise. Statements made by any person, including representatives of Seller, which are inconsistent or in conflict with the terms of this warranty shall not be binding upon Seller unless reduced to writing and approved by an officer of Seller.

## Warranty Replacement and Adjustment

All claims under warranty must be made promptly after occurrence of circumstances giving rise thereto, and must be received within the applicable warranty period by Seller or its authorized representative. Such claims should include the Product serial number, the date of shipment, and a full description of the circumstances giving rise to the claim. Before any Products are returned for repair and/or adjustment, written authorization from Seller or its authorized representative for the return and instructions as to how and where these Products should be returned must be obtained. Any Product returned to Seller for examination shall be prepaid via the means of transportation indicated as acceptable by Seller. Seller reserves the right to reject any warranty claim not promptly reported and any warranty claim on any item that has been altered or has been returned by non-acceptable means of transportation. When any Product is returned for examination and inspection, or for any other reason, Customer shall be responsible for all damage resulting from improper packing or handling, and for loss in transit, notwithstanding any defect or non-conformity in the Product. In all cases, Seller has the sole responsibility for determining the cause and nature of failure, and Seller's determination with regard thereto shall be final.

If it is found that Seller's Product has been returned without cause and is still serviceable, Customer will be notified and the Product returned at Customer's expense; in addition, a charge for testing and examination may be made on Products so returned.

*This page intentionally left blank.*

# Contents

<b>Preface</b> .....	<b>v</b>
Hazard and Safety Information .....	v
EMC Warnings .....	vi
<b>Introduction</b> .....	<b>1-1</b>
Backwards Compatibility .....	1-1
Part Number Scheme .....	1-1
XGS-600 Front and Back Description .....	1-2
Unit Dimensions .....	1-3
<b>Installation</b> .....	<b>2-1</b>
Connect the Unit.....	2-1
<b>Operating Instructions</b> .....	<b>3-1</b>
Operational Screens.....	3-1
<b>Service and Troubleshooting</b> .....	<b>4-1</b>
Troubleshooting.....	4-5
<b>Appendix A. XGS-600 Gauge Specifications</b> .....	<b>A-1</b>
Instrument Specifications .....	A-1
Board Specifications/Descriptions .....	A-3
I/O Pin Assignments.....	A-6
XGS-600 vs MultiGauge and SenTorr Backwards Compatibility Detail.....	A-9
<b>Appendix B. ASCII Serial Commands</b> .....	<b>B-1</b>
<b>Appendix C. BCD Serial Commands</b> .....	<b>C-1</b>
<b>Appendix D. Gas Correction Factor Table</b> .....	<b>D-1</b>

*This page intentionally left blank.*



Declaration of Conformity  
 Konformitätserklärung  
 Déclaration de Conformité  
 Declaración de Conformidad  
 Verklaring de Overeenstemming  
 Dichiarazione di Conformità

We  
 Wir  
 Nous  
 Nosotros  
 Wij  
 Noi

Varian, Inc.  
 121 Hartwell Avenue  
 Lexington, MA, 02421-3133 USA

declare under our sole responsibility that the product,  
 erklären, in alleniniger Verantwortung, daß dieses Produkt,  
 déclarons sous notre seule responsabilité que le produit,  
 declaramos, bajo nuestra sola responsabilidad, que el producto,  
 verklaren onder onze verantwoordelijkheid, dat het product,  
 dichiariamo sotto nostra unica responsabilità, che il prodotto,

**XGS-600 Gauge Controller**

to which this declaration relates is in conformity with the following standard(s) or other normative documents.  
 auf das sich diese Erklärung bezieht, mit der/den flogenden Norm(en) oder Richtlinie(n) übereinstimmt.  
 auquel se réfère cette déclaration est conforme à la (auz) norme(s) ou au(x) document(s) normatif(s).  
 al que se refiere esta declaración es conforme a la(s) norma(s) u otro(s) documento(s) normativo(s).  
 waamaar deze verklaring verwijst, aan de volende norm(en) of richtlijn(en) beantwoordt.  
 a cui se riferisce questa dichiarazione è conforme alla/e sequente/l norma/o documento/l normativo/i.

- EN 55011 (1991) . . . . . Group 1 Class A ISM emission requirements
- EN 61010-1 (1993) . . . . . Safety requirements for electrical equipment for measurement, control, and laboratory use incorporating Amendments Nos 1 and 2.
- EN 61000-3-2 (2006) . . . . . Limits for harmonic current emissions (equipment input current up to and including 16A per phase).
- EN 610000-3-3 (2005) . . . . . Limitation of voltage fluctuations and flicker in low-voltage supply systems for equipment with rated current up to and including 16A.
- EN 61326 (1997/A1; 1998/A2; 2001/A3) . . . . . EMC requirements for Electrical equipment for measurement, control and laboratory use — General Use.
- EN 61326 (1997/A1; 1998/A2; 2001/A3) . . . . . EMC requirements for Electrical equipment for measurement, control and laboratory use
- EN 61000 - 4-2 (2001) . . . . . Electrostatic Discharge Immunity
- EN 61000 - 4-4 (2004) . . . . . Electrical Fast Transient Immunity
- EN 61000 - 4-5 (2005) . . . . . AC Lightning Surge Immunity

John Ehman  
 Operations Manager  
 Varian, Inc.  
 Lexington, Massachusetts, USA

August 27, 2008



*This page intentionally left blank.*



# Preface

## Hazard and Safety Information

This manual uses the following standard safety protocols:

**WARNING**



*The warning messages are for attracting the attention of the operator to a particular procedure or practice which, if not followed correctly, could lead to serious injury.*

**CAUTION**



*The caution messages are displayed before procedures, which if not followed, could cause damage to the equipment.*

**NOTE**



*The notes contain important information.*

This product must only be operated and maintained by trained personnel. Board installation/replacement requires a properly trained service technician.

Before operating or servicing equipment, read and thoroughly understand all operation/maintenance manuals provided by Varian. Be aware of the hazards associated with this equipment, know how to recognize potentially hazardous conditions, and how to avoid them. Read carefully and strictly observe all cautions and warnings. The consequences of unskilled, improper, or careless operation of the equipment can be serious.

In addition, consult local, state, and national agencies regarding specific requirements and regulations. Address any safety, operation, and/or maintenance questions to your nearest Varian office.

### EMC Warnings

#### EN 55011 Class A Warning

This is a Class A product. In a domestic environment this product may cause radio interference in which case the user may be required to take adequate measures.

The XGS-600 was tested with Varian manufactured gauge cables whose pigtails are connected to the XGS-600 ground stud, and with I/O cables (for remote control, serial communications and set points) employing combined foil-braid shields and metal shell connectors with the shields connected to the XGS-600 chassis. Compliance with FCC Part 15 rules and the European Union's EMI requirements cannot be assured unless Varian supplied gauge cables and foil-braid shielded I/O cables with metal shell connectors are used. Failure to install the unit in this way may result in the failure to meet the requirements for radiated emissions and susceptibility.

#### FCC

This device complies with Part 15 of the FCC rules. Operation is subject to the following two conditions: (1) This device may not cause harmful interference, and (2) this device must accept any interference received, including interference that may cause undesirable operation.



*The equipment has been tested and found to comply with the limits for a Class A digital device, pursuant to Part 15 of the FCC rules. These limits are designed to provide reasonable protection against harmful interference when the equipment is operated in a commercial environment. This equipment generated, uses, and can radiate radio frequency energy and, if not installed and used in accordance with the instruction manual, may cause harmful interference to radio communications. Operation of this equipment in a residential area is also likely to cause harmful radio communications interference in which case the user will be required to correct the interference at his own expense.*



*It has been observed that transient electromagnetic phenomena (electrostatic discharges and power line voltage spikes and/or surges) can cause the XGS-600 to interrupt a measurement cycle with an error or a blank screen. If this occurs, power cycle the XGS-600 in order to repeat the measurement.*

# Chapter 1: Introduction

Congratulations on your purchase of the XGS-600. This product represents a major advance in the simplicity, functionality and performance of vacuum gauge controllers. It was conceived after extensive interviews with end users in a variety of applications. Its design incorporates the latest in electronics and is CE and CSA certified and RoHS compliant. It is compact, taking only ½ rack and it is simply without peer in terms of its capacity, usability and capability.

You can view up to 8 gauges on one screen and can employ as many as 5 ion gauges or 12 convection gauges in one unit. With its simple user interface (designed to be operated without a manual) and its many standard features (8 set points, serial communication, universal voltage and pressure units), vacuum measurement is simplified. And where speed is necessary for certain critical applications it was designed to process a signal in less than 20 milliseconds. These are just some of the many features that make the XGS-600, a unique and powerful device. Once you have used the XGS-600, we trust that you, too will find that it is not only a convenient and economical tool in your vacuum system but an indispensable one as well.

Read this manual carefully to discover all the capability of this device, but if you don't have time, simply turn it on and navigate through the screens to get started.

## Backwards Compatibility

The XGS-600 is designed to be backward compatible with the SenTorr and MultiGauge instruments. Refer to page A-9 for a full description.

## Part Number Scheme

Description	Part Number
XGS-600 Vacuum Controller, without cards	XGS600H0M0C0
Configure your XGS-600 Controller with cards – constructing your part number:	XGS600HXMCC
1 Refer to the Gauge Selection Chart to help determine the gauge you need	
2 Choose the number of HFIG** cards you want; place after the "H"; will be 0 to 4	
3 Choose the number of IMG* cold cathode cards you want; place after the "M"; will be 0 to 5	
4 Choose the number of Dual Convection Gauge Cards; place after the "C"; each card runs two convection type gauges, will be 0 to 6	

**Note:**

- The XGS-600 has 6 gauge card slots permitting a total of 6 cards.
- Up to four slots can be used for HFIG\*\* cards. If four of these are chosen, one IMG\* card or up to two Dual Convection Gauge Cards may be selected also.
- Up to five slots can be used for IMG\* cards. If five of these are chosen, no additional gauge cards may be selected.
- All six slots may be used for Dual Convection Gauge Cards.

\*\* HFIG = Hot Filament Ion Gauge      \* IMG = Inverted Magnetron Gauge

## XGS-600 Front and Back Description

The display is biased so as to be best viewed from directly in front or slightly above.



Figure 1-1 XGS-600 Front Panel

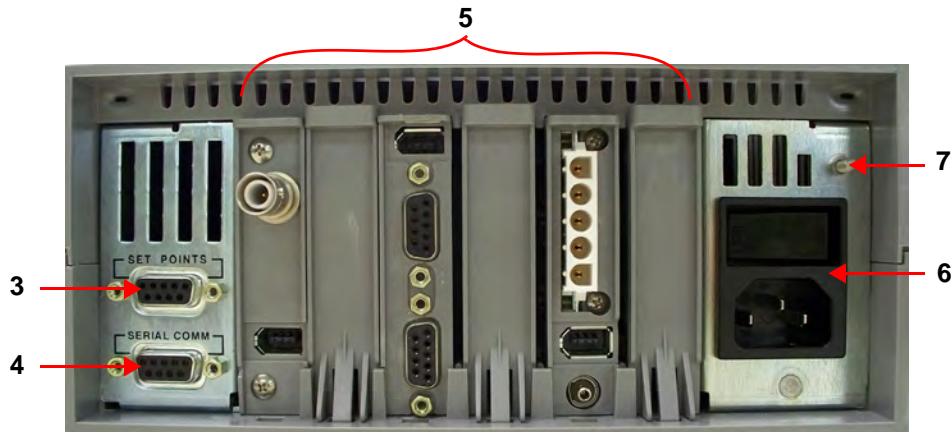

Figure 1-2 Backplate Connections

Table 1-1 Front/Rear Panel Components

Item	Description	Page
1	Display	See "Screen Flow" on page 3-1.
2	Keypad/Navigation Keys	See "General Navigation and Data Entry" on page 3-2.
3	Set Point Outputs	See "Set-Point Connector Pin Assignments" on page A-7.
4	Serial Communication Connector	"Serial Connector Pin Assignments" on page A-8.
5	Gauge Board Slots (6)	See "Board Specifications/Descriptions" on page A-3.
6	On/Off Power Switch and AC Power Plug Receptacle	See "Connect the Unit" on page 2-1.
7	Ground Connection	See "Connect the Unit" on page 2-1.

# XGS-600 Gauge Controller

## Unit Dimensions

Figure 1-3 shows the unit dimensions with mm in brackets.

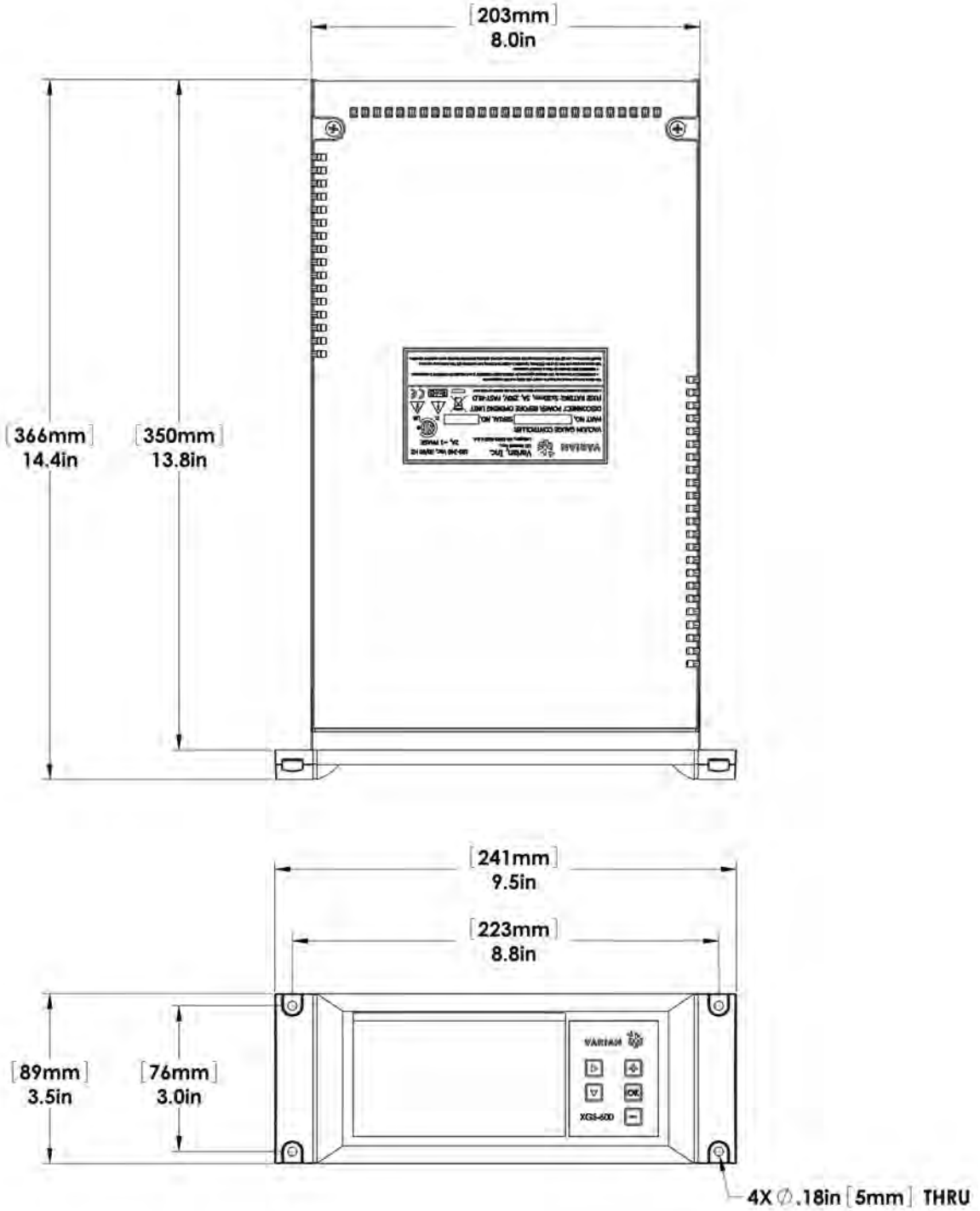

Figure 1-3 XGS - 600 Dimensions

## XGS-600 Gauge Controller

---

*This page intentionally left blank.*

## Chapter 2: Installation

Each XGS-600 unit is inspected and carefully packed prior to shipment. If the unit arrives damaged, save the packing materials and immediately notify the carrier. Because the packing materials are designed specifically for this instrument, always use them when transporting the unit. The shipping container is packed with the following contents:

- ❑ XGS-600 gauge controller
- ❑ AC line cord
- ❑ Operating manual
- ❑ Rubber feet, adhesive

### Connect the Unit

The unit comes shipped with sensor boards configured according to customer requirements.

**CAUTION**



*Do not block air vents. Allow approximately 3/4" clearance at each side of the enclosure for proper air flow.*

1. Plug the AC line cord into the receptacle on the rear panel of the unit and into the power source. Keep power off while connecting the remaining cables.
2. Connect gauge and I/O cables depending on controller configuration according to Figure 2-1:

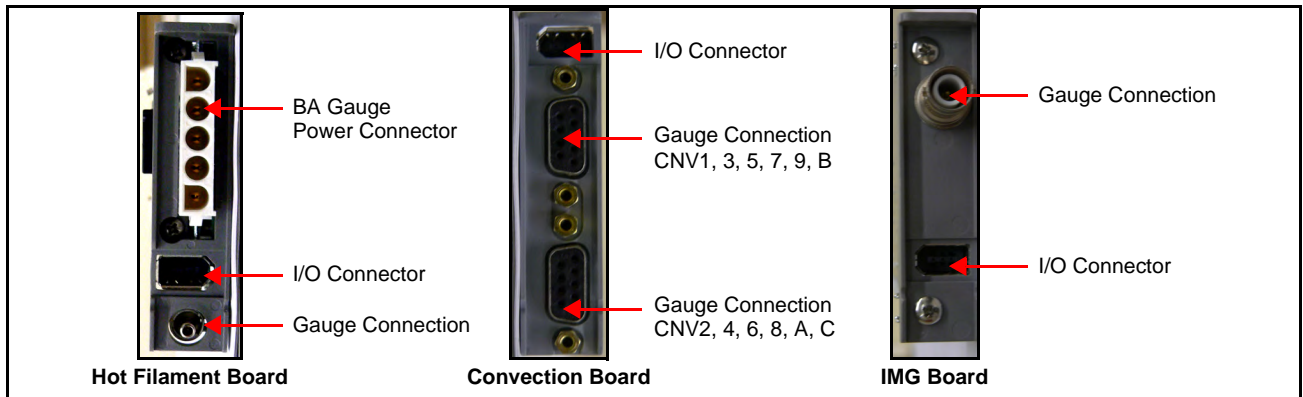

**Figure 2-1 Gauge Board Rear Connections**

**NOTE**



*When installing and HFIG cable, make sure to connect the pig tails from the ground cable to the ground stud. See item 7 in Figure 1-2.*

## XGS-600 Gauge Controller

3. Turn on the unit using the rear panel power switch.



*Gauges and accessories are available for the XGS-600 controller such as rack mount hardware, gauge and I/O cables, and a tilt stand. See Table 2-1 and Table 2-2.*

**Table 2-1 XGS-600 Accessories**

Cables	Part Number						
Cable Description	10 ft.	25 ft.	50 ft.	65 ft	75 ft	90 ft	100 ft
UHV-24/UHV-24p Teflon UHV, bakeable to 250° C	R32463010	R32463025	R32463050				
UHV-24/UHV-24p Standard, non-bakeable	R32453010	R32453025	R32453050				
Glass BA Gauge Standard, non-bakeable	R32443010	R32443025	R32443050				
Ion Gauge Extension				R32473065		R32473090	
MBA-100 Gauge	R32483010	R32483025	R32483050				
IMG-100 Gauge	R03113010	R03113025	R03113050		R03113075		R03113100
IMG-UHV Gauge	R03413010	R03413025		R03413065			R03413100
Thermocouple Gauge	L91313010	L91313025	L91313050		L91313075		L91313100
ConvecTorr Gauge, Non-Bakeable	L91223010	L91223025	L91223050				L91223100
XGS-600 I/O	R32493010	R32493025	R32493050	Special Order			
Other Accessories	Part No.	Power Cord Selection					Part No.
HFIG** PCB, Field Install	R3075301	Europe, 10A /220-230 VAC, 2.5 Meter					656494220
IMG* PCB, Field Install	R3080301	Denmark, 10A/220-230 VAC, 2.5 Meter					656494225
Thermocouple/Convector Gauge card PCB, Field Install	R3084301	Switzerland, 10A/230 VAC, 2.5 Meter					56494235
Tilt Stand Accessory	R3124301	UK/Ireland, 13A/230 VAC, 2.5 Meter					656494250
Center Rack Mount Kit	L6423301	India, 10A/220-250 VAC, 2.5 Meter					656494245
Off-Center Rack Mount Kit	L6422301	Israel, 10A/230 VAC, 2.5 Meter					656494230
Dual Mount Rack Mount Kit	L6426301	Japan, 12A/100 VAC, 2.3 Meter					656494240
Four Channel TC Cable Adapter	R3299301						
MHV-SHV Adapter	648072683						
		North America, 15A/125 VAC, 2.0 Meter					656458203
		North America, 10A/230 VAC, 2.5 Meter					656494255



# XGS-600 Gauge Controller

## Table 2-2 Gauge Selection Chart

Controller Gauge Card						
Vacuum Regime	Convection	Hot Filament	Cold Cathode	Gauge Type	Recommendation	Gauge Characteristics
	C	H	M			
Rough ATM to 10 <sup>-3</sup>	✓			ConvecTorr	Best overall convection gauge for accuracy repeatability, secure connection	<ul style="list-style-type: none"> <li>Stainless steel</li> <li>Pipe thread, KF and CFF</li> <li>Locking bayonet connector</li> </ul>
	✓			536	Same vacuum performance as the ConvecTorr but without bayonet connector	<ul style="list-style-type: none"> <li>Stainless steel</li> <li>Pipe thread, KF and CFF</li> </ul>
	✓			531	Most economical rough gauge	<ul style="list-style-type: none"> <li>Lowest cost</li> <li>Mild steel</li> <li>Pipe thread</li> </ul>
High 10 <sup>-3</sup> to 10 <sup>-9</sup>		✓		572 (glass)	Most popular general purpose HV gauge (hot filament)	<ul style="list-style-type: none"> <li>Measures to 1 x 10<sup>-9</sup> Torr</li> <li>Tungsten filaments - More accurate and repeatable</li> <li>Glass - Can see when it is on</li> </ul>
		✓		563 (glass)	Best general purpose HV gauge (hot filament) for overall performance and reliability	<ul style="list-style-type: none"> <li>Measures to 1 x 10<sup>-9</sup> Torr</li> <li>Thoriated iridium filament - More robust with better burnout resistance</li> <li>Glass - Can see when it is on</li> <li>Platinum coating - Provides higher performance in the 10<sup>-4</sup> range and a measure of EMI shielding</li> </ul>
		✓		571 (glass)	Same as 563 without platinum coating	<ul style="list-style-type: none"> <li>Less expensive than the 563</li> </ul>
		✓		MBA-100 (one filament, metal case) MBA-200 (two filaments, metal case)	Break resistant HV gauge (hot filament)	<ul style="list-style-type: none"> <li>Measures to 10<sup>-9</sup> Torr</li> <li>General purpose hot filament with metal housing (not glass) , so it will not break</li> <li>Uses less power than glass gauges.</li> <li>Well shielded</li> <li>Available in tungsten and thoriated iridium filament (see 572 and 563 above)</li> </ul>
				✓	IMG-100 Inverted Magnetron	Most durable and fastest responding HV gauge (cold cathode)

*Continued on next page*

## XGS-600 Gauge Controller

**Table 2-2 Gauge Selection Chart (Continued)**

Controller Gauge Card						
Vacuum Regime	Convection	Hot Filament	Cold Cathode	Gauge Type	Recommendation	Gauge Characteristics
	C	H	M			
Ultra High 10-9 to 10-12			✓	IMG-300 Inverted Magnetron	Most durable and fastest responding UHV gauge (cold cathode)	<ul style="list-style-type: none"> <li>• Measures to <math>1 \times 10^{-11}</math> Torr</li> <li>• Bakeable with magnet to 250 °C</li> <li>• Bakeable without magnet to 450 °C</li> <li>• Reliable, rugged, will not burn out</li> <li>• Can be cleaned</li> </ul>
		✓		UHV-24 (nude)	Most popular UHV gauge (hot filament)	<ul style="list-style-type: none"> <li>• Measures to <math>1 \times 10^{-10}</math> Torr</li> <li>• Bakeable with magnet to 250 °C</li> <li>• Thoriated iridium filaments run cooler - less outgassing</li> <li>• Dual tungsten filaments run hotter - More outgassing but measurements are more accurate and repeatable</li> </ul>
		✓		UHV-24p (nude)	UHV gauge providing the highest vacuum reading	<ul style="list-style-type: none"> <li>• Same as UHV-24 except it measures to <math>2 \times 10^{-11}</math> Torr</li> </ul>

### BA Cross Reference

The XGS-600 controller is compatible with many competitor gauges. Table 2-3 indicates which Varian gauge setting should be used for each of these gauges. See "Sensor Setup Screen" on page 3-9.

**Table 2-3 BA Cross Reference**

GP	ETI	MDC	Huntington	Kurt Lesker	Duniway
<b>Select Sensor model 572 for the following:</b>					
274012	4336-TP/1		TP-100	G100TF	T-075-N
274013	4336-TP		TK-100	G075TK	T-075-P
274015	4336-TK		TK-100-F		T-075-K
274016	4336-TK/1				T-100-N
274017					T-100-K
274018					T-100-P
274021					T-CFF-133
					T-CFF-275
					T-KF25
					T-KF40

## XGS-600 Gauge Controller

**Table 2-3 BA Cross Reference (Continued)**

GP	ETI	MDC	Huntington	Kurt Lesker	Duniway
<b>Select Sensor model 571 for the following:</b>					
274002	4336-P	IGT-075	IP-100	G075F	I-075-N
274003	4336-K	IGT-100	IK-100	G100F	I-075-P
274005	4336-F		IK-100-F	G100KQF25	I-075-K
274006	4336-P/1		IP-150	G100KQF40	I-100-N
274008	4336-F/1		IK-150	G075N	I-100-K
274020	4336-K/1		IK-150-F	G100K	I-100-P
274032	8140				I-CFF-133
274028					I-CFF-275
274043					I-KF25
					I-KF40
<b>Select Sensor model UHV24 for the following:</b>					
274022	8130	UH TT	IGT-T	G8130	T-NUDE-F
274023	8130T	UH IR	IGT-TI	G8130T	I-NUDE-F
274041		BATT			
274042		BAIR			
<b>Select Sensor model 563 for the following:</b>					
				G8140	I-075-NC
				G8120	I-075-KC
				G8140-DI	I-100-NC
				G100K-PT	I-100-KC
				G100F-PT	IC=CFF-275
					I-NUDE-BAC
<b>Select Sensor model 564 for the following:</b>					
				GX100-564F	I-164-K
				GX100-564K	I-164-N
				GX100-564N	I-164-275
					I-164-KF25
					I-164-KF40

## XGS-600 Gauge Controller

---

*This page intentionally left blank.*

# Chapter 3: Operating Instructions

## Operational Screens

### Screen Flow

Figure 3-1 shows the screen flow.

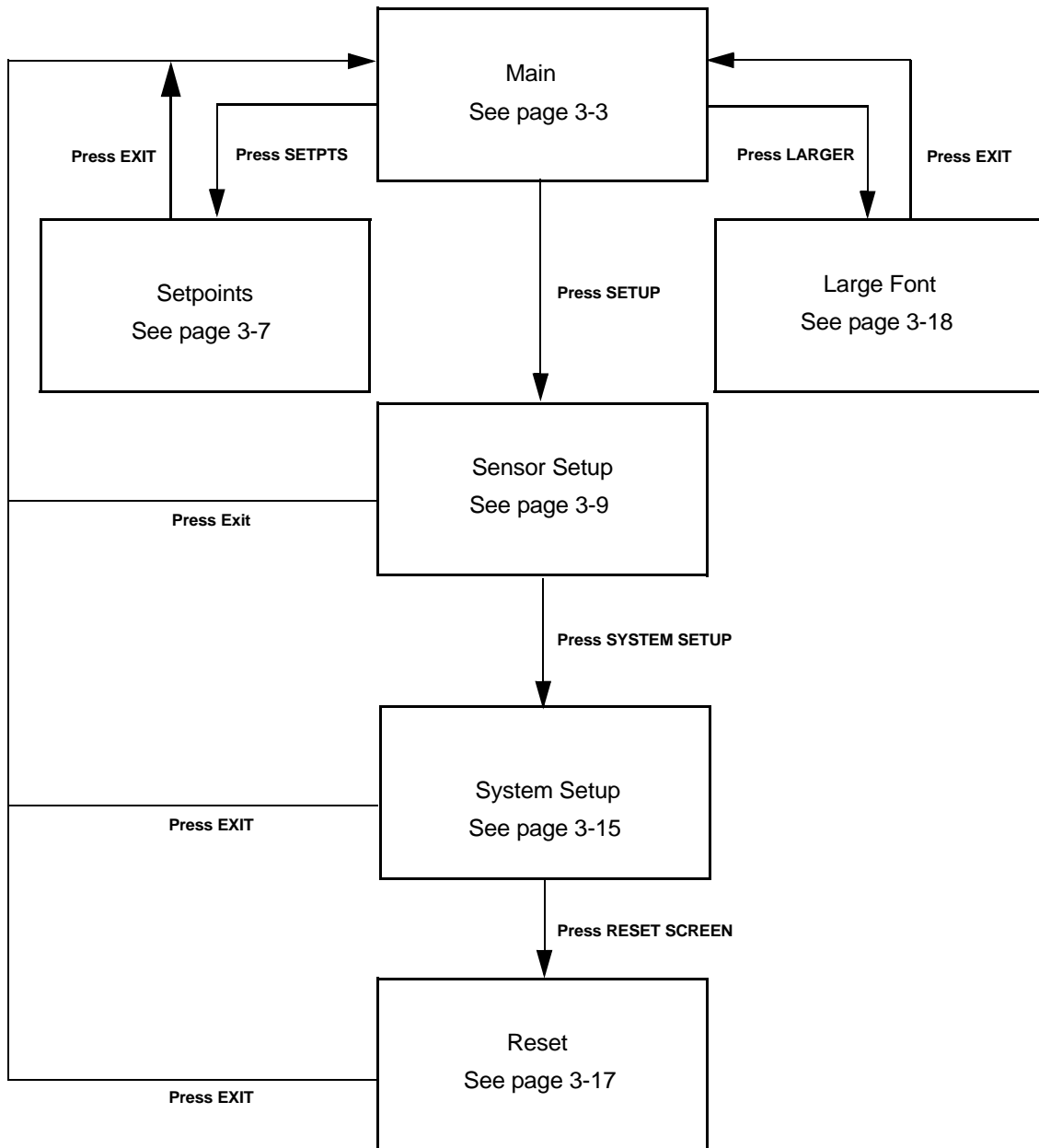

Figure 3-1 Screen Flow

### General Navigation and Data Entry



Use navigation keys to locate cursor on an area of interest (ex. data entry, gauge control or screen navigation soft key). Only fields that are user-variable are accessible by the cursor. Hold the key pressed for faster cursor movement.



Press the + or - keys to increment/decrement the field value through all options. Hold the key pressed for fast increments/decrements.



Use the OK key to accept the selected option or data.

Examples:

Turning a gauge on:

- a. Cursor over to the control field for a gauge.
- b. Press + or - keys to view control options (ON, OFF, etc).
- c. Press **OK**.

Modifying a number:

- a. Cursor over to the number.
- b. Press + or - keys to increment/decrement number.
- c. Press **OK**.

Navigating to another screen:

- a. Cursor over to the screen navigation soft key (usually lower right corner of screen).
- b. Press **OK**.

#### **NOTE**



*Escape keys: While scrolling through options or data using the +/- keys, you can escape without accepting new data by pressing any cursor navigation key. The original data is kept and displayed.*

## Main Screen

Figure 3-2 shows the main screen, which appears at power up.



*The sequence of gauge rows follows the board installation sequence from left to right (when viewed from the front).*

Use this screen to:

- View a list of installed sensors.
- View real-time pressure readings and status by sensor.
- Turn an ion gauge on/off or calibrate a Convection gauge.
- View the setpoint status.

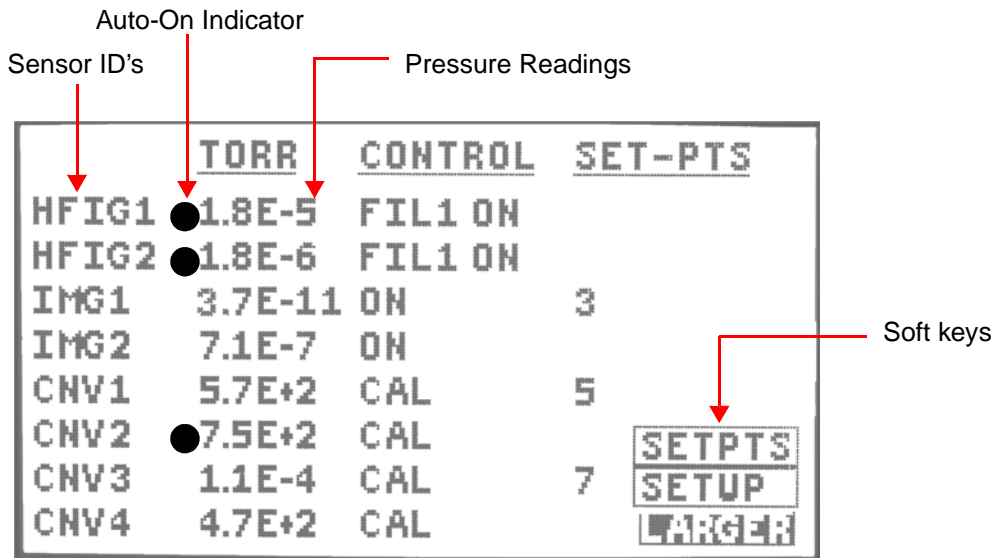

**Figure 3-2 Main Screen**

### Soft Keys

- |        |  |
|--------|--|
| SETPTS | Select to open the Set Point screen (page 3-7).                            |
| SETUP  | Select to open the Sensor Setup screen (page 3-9) and other setup screens. |
| LARGER | Select to open the Large Font screen (page 3-18).                          |



The NEXT key appears if there are more than eight gauges. Use this key to move to the next Main screen with the additional gauges.

## XGS-600 Gauge Controller

---

Sensor ID's	Lists the five-character User Label configured on the "Sensor Setup Screen" on page 3-9.
Auto-On Indicator	<p>Indicates Auto-On has been set up, using the Sensor Setup screen, between a convection and an ion gauge(s). The same symbol appears next to both the convection and the ion gauge showing the link between the two.</p> <p>In the screen shown, convection gauge <i>CNV2</i> has been set up to trigger both ion gauges <i>HFIG1</i> and <i>HFIG2</i>.</p> <p>Multiple Auto-ON setups are possible, with a different symbol shape for each Convection gauge.</p> <p>See "Sensor Setup Screen" on page 3-9 for Auto-ON details.</p>
Pressure Reading	<p>Displays the gauge pressure reading. The pressure units, as selected in the System Setup screen, appear at the top of the column:</p> <ul style="list-style-type: none"><li><input type="checkbox"/> Convection gauge readings always appear, as they are always on.</li><li><input type="checkbox"/> For ion gauges,  appears when a gauge is first turned on, until the software determines a valid reading.</li></ul> <p>See Table 4-1 on page 4-5 for error messages displayed in this column.</p> <p>If an ion gauge error message appears in the pressure reading column and the control column indicates OFF, clear the error as follows:</p> <ol style="list-style-type: none"><li>1. Press <b>OK</b> or reselect <b>OFF</b> in the control column.</li><li>2. Scroll to ON option to turn the gauge on.</li></ol>



## XGS-600 Gauge Controller

---

### Control

Use this column to input operational commands to the system. The options available are:

Hot Filament Gauges:

- OFF
- FIL1 ON
- FIL2 ON
- DEGAS 1 ON (See section below)
- DEGAS 2 ON
- DEGAS OFF

Convection Gauges:

- CAL

Inverted Magnetron Gauges:

- OFF
- ON

### Degas (HFIG only):

To activate the DEGAS function, select **DEGAS1 ON** or **DEGAS2 ON** depending on which filament is currently on.

Emission has to be on before Degas starts, and the pressure reading must be below 1E-5T (or equivalent in other units). When Degas times out (approximately 25 minutes), the field reverts to *FIL1* or *FIL2*, whichever filament is in use.

### NOTE



*Degas Limitations: All gauges operate simultaneously, but only two hot filament gauges can degas at the same time. Additional degasses are not allowed by the system.*

To terminate degas manually, select **Degas OFF**. The field reverts to Fil1 or Fil2. Turning off degas momentarily turns off emission.

### CAL (CNV only):

Convection TC gauges are calibrated using this control. The XGS-600 uses Varian's Smart Cal, which automatically determines whether to perform a vacuum calibration or atmosphere calibration based on the pressure presented to the sensor.

## XGS-600 Gauge Controller

---



*Convection gauge calibration at atmosphere depends on orientation. Be sure to install the gauge sensor in final orientation before calibrating.*

To calibrate:

1. Cursor down to the *CAL* control for the required gauge.
2. Present either vacuum or atmospheric pressure to the gauge. (Allow the gauge to stabilize for 15 minutes after first power up.)
3. Press **OK**.

Vacuum calibration defaults to 1E-4T and atmosphere calibration defaults to 760T (or equivalents in mbar and Pa). See "System Setup Screen" on page 3-15 for modifying atmospheric pressure to your regional value. See "Sensor Setup Screen" on page 3-9 for selecting gas type. See "Convection Gauge Board" on page A-4 for activating the same calibration using rear-panel I/O controls, and "ASCII Serial Commands" on page B-1.

It is normal for the vacuum reading of Convectorr and TC gauges to fluctuate somewhat when at high vacuum after calibration. Typically, you can expect the readings to be anywhere from 1.0E-4 Torr to ~3.0E-4 Torr with an occasional reading as high as 1.0E-3 Torr (or equivalent mbar and Pa).

SET-PTS (Set Points)

Displays the setpoints activated. The setpoints are numbered on the Set Point screen (page 3-7).

The setpoint number appears if all following conditions met:

- The setpoint is assigned to the sensor,
- The setpoint screen is set to AUTO for that setpoint,
- And the setpoint has been activated.

## XGS-600 Gauge Controller

### Set Point Screen

To open this screen select **SETPTS** on the *Main* screen.

#	SETPT	ON&DELAY	OFF&DELAY	EXIT
1	HFIG1	3E-09 0.0	9E-08 0.0	OFF
2	HFIG2	8E-08 0.1	3E-06 2.0	AUTO
3	IMG1	7E-08 0.0	5E-07 0.0	AUTO
4	IMG2	2E-09 0.5	1E-08 0.1	AUTO
5	CNV1	6E+02 0.0	7E+02 0.0	AUTO
6	CNV2	1E-01 0.1	3E-01 1.3	AUTO
7	NONE	8E-02 0.2	1E+00 0.0	OFF
8	CNV4	1E-02 1.0	1E-01 5.0	ON

**Figure 3-3 Set Point Screen**

- Set Point #** This number corresponds to the sequence of eight rear panel Set Point outputs. This is also the number that appears on the *Main* screen if the setpoint is activated. These are fixed numbers and not user changeable.
- SETPT** Select an available gauge in this list to assign to a Setpoint #. Only two set points are allowed per sensor. If two setpoints are already assigned to a sensor, that sensor does not appear in the list of options for this field.
- NONE** is available as a choice. If selected, all pressures and delays are set to zero and OFF.
- ON** Select a Setpoint On pressure value. If the sensor pressure falls below this value, the rear panel output activates (voltage low) and the Setpoint # appears on the Main screen next to that sensor. The ON reading must be a lower pressure than the OFF reading or an error (ERR) warning appears in the rightmost column. Once valid settings are entered, *ERR* changes to *AUTO*.
- See "XGS-600 Gauge Specifications" on page A-1 for setpoint output specifications and setpoint connector pin-outs.
- ON DELAY** If a delay is required between the time the sensor detects the Setpoint ON pressure value and the outputs activates (rear panel, Main screen indicator and serial communication), select a delay time in seconds. Example: A setting of 1.2 results in a delay of approximately 1.2 seconds.

## XGS-600 Gauge Controller

---

OFF	Select a Setpoint OFF pressure value. If the sensor pressure rises above this value, the rear panel output de-activates (voltage high) and the Setpoint # clears from the Main screen. The OFF reading must be a higher pressure than the ON reading or an error (ERR) warning appears in the rightmost column. Once valid settings are entered, ERR changes to AUTO.
OFF DELAY	If a delay is required between the time the sensor detects the Setpoint OFF pressure value and the output, de-activates (rear panel, Main screen indicator and serial communication), select a delay time in seconds. Example: A setting of 1.2 results in a delay of approximately 1.2 seconds.
AUTO/ON/OFF	Options include: <ul style="list-style-type: none"><li><input type="checkbox"/> AUTO indicates the setpoint state is determined by comparing the pressure to the setpoint limits. This is the default setting and is used to enable the setpoint.</li><li><input type="checkbox"/> OFF and ON are override values, which can also be used for manual testing. Selecting OFF or ON does not clear pressure/time settings.</li></ul>
EXIT SOFT KEY	Select to return to the main screen (page 3-3).

Sensor Setup Screen

To open this screen select **SETUP** on the Main screen.

<b>SENSOR SETUP</b>		
<b>SENSOR ID</b>	HF1G1	
<b>USER LABEL</b>	HFIG1	
<b>SENSOR MODEL</b>	563	
<b>AUTO ON IF GAUGE</b>	-----	< 1E-3
<b>ANALOG OUTPUT</b>	SLOW	
<b>SENSITIVITY</b>	10.0	
<b>EMIS CURRENT(MA)</b>	04.0	SYSTEM SETUP
<b>GAS CORRECTION</b>	1.00	

Figure 3-4 Sensor Setup Screen: HFIG and IMG Sensors

<b>SENSOR SETUP</b>		
<b>SENSOR ID</b>	CNV2	
<b>USER LABEL</b>	CNV2	
<b>SENSOR MODEL</b>	-----	
<b>AUTO ON IF GAUGE</b>	-----	< 1E-3
<b>ANALOG OUTPUT</b>	SLOW	
<b>SENSITIVITY</b>	----	SYSTEM SETUP
<b>EMIS CURRENT(MA)</b>	----	
<b>GAS TYPE</b>	AIR	

Figure 3-5 Sensor Setup Screen: CNV (Convection) Sensors

See Table 3-1 on page 3-11 for default values. Fields that are unavailable have - - -.

## XGS-600 Gauge Controller

---

Sensor ID	<p>Use this field to select the sensor to view its setup parameters. Displays the unique system-assigned gauge identification. Scroll through this list to select a sensor and the remainder of fields on the screen populate with its present settings.</p>
	<p>Possible sensor ID's are:</p> <ul style="list-style-type: none"><li><input type="checkbox"/> HFIGx for Hot Cathode Ion Gauge boards using BA or UHV sensors.</li><li><input type="checkbox"/> CNVx for Convection boards (TC/ConvecTorr)</li><li><input type="checkbox"/> IMGx for IMG Gauge boards</li></ul>
	<p>where x indicates the number of the transducer attached. The number is system-assigned based on the sequence of board installation, left to right (when viewed from the front). Convection boards have two sensors per board. When more than 4 convection boards are installed, the 10, 11, and 12 channels are designated CNVA, CNVB, and CNVC, respectively.</p>
User Label	<p>Use this field to enter your label for this sensor that appears on all other screens and serial communication. This field has a maximum of five (5) characters and any alphanumeric character is available for use.</p> <p>User Labels that begin with HFIG, CNV or IMG are not allowed to avoid confusion with Sensor ID's.</p> <p>If no User Label is selected, the default is the Sensor ID. When a System Reset is initiated, this label is reset to the sensor ID.</p>
Sensor Model	<p>Use this field to configure the particular model of sensor attached to a board.</p>

**NOTE**



*If Sensor Model is changed, all fields resort to default values.*

## XGS-600 Gauge Controller

**Table 3-1 Default Setup Values by Ion Gauge Type**

HFIG Sensor Model	Default Emis Current (ma)	Default Sensitivity	Over-pressure limit (mT)+	Default Degas Power (mA)	Number of Filaments
MBA100	0.1	25	1-10*	1	1
MBA200	0.1	25	1-10*	1	2
571	4	10	1-10*	10	1
572	4	10	1	10	2
563	4	10	1-10*	10	1
564	0.1	6	1-10*	10	1
UHV24 (default)	4	25	1	10	2
UHV24p	4	20	1	10	2
IMG 100 (default)	N/A	2.0	10 (Hi Voltage stays ON)	N/A	N/A
IMG 300	N/A	2.5	10 (Hi Voltage stays ON)	N/A	N/A

+ Not a user-variable setup parameter

\* If Emission Current is set:

- Less than 0.7 mA, overpressure is 10 mT (or equivalent in mbar or Pascal).
- Greater than 0.7 mA, overpressure is 1 mT (or equivalent in mbar or Pascal).

**AUTO-ON IF GAUGE** This field is active for HFIG and IMG gauges only. Use this field along with < (is less than) to select a Convection gauge and assign a pressure level below which AUTO-ON engages.

When Auto-On is activated, you cannot manually turn on or off the ion gauge; it is controlled by the assigned convection gauge. Select - - - to deactivate Auto On.

< (is less than)

Use this field with Auto-ON to enter pressure (max allowed 1T) at which to trigger the ion gauge. There is a hysteresis of 5mT built in to the software to prevent fluctuating ion gauge emission from triggering on/off. For example, if this field is set to 3E-3T, Auto-ON turns on the ion gauge at 3E-3T and off at 8E-3T.

## XGS-600 Gauge Controller

---

ANALOG OUTPUT	Use this field to select either the FAST or SLOW analog output. Select: <ul style="list-style-type: none"><li><input type="checkbox"/> FAST and the output is updated every 10 msec.</li><li><input type="checkbox"/> SLOW and the update is every 250 msec.</li></ul> The default setting is FAST for the IMGs, SLOW for hot filament and rough gauges.
SENSITIVITY	This field is active for HFIG and IMG gauges only. Use this field to raise or lower the sensitivity.
EMIS CURRENT (mA)	This field is active for HFIG gauges only. Use this field to configure the EMIS Current. See Table 3-1 on page 3-11 for sensor default values.
	<b>NOTE</b> <i>Changing the Sensor Model, defaults Sensitivity and Emission Current settings.</i>
GAS CORRECTION	(HFIG and IMG gauges) Use this field to enter a correction for various gas types. For an ion gauge, enter a nominal value from Appendix D "Gas Correction Factor Table".
GAS TYPE	(Convection gauges) Use this field to enter a gas type by name. Select <i>Air</i> , <i>Argon</i> or <i>Helium</i> ("Helium Measurement Capability" on page 3-14).
SYSTEM SETUP	Select to open the System Setup screen (page 3-15).
EXIT	Select to return to the Main Screen (page 3-3).

### Selecting Emission Current for Hot Filament Ion Gauges

When the gauge model number is selected, the XGS-600 automatically selects a default emission current value that works for most applications. However there are reasons why you may want to select another value based upon your application.

- If you are using a gauge at pressures higher than 1.0E-4 Torr, the gauge performs better and lasts longer at low values of emission current. In general, for this pressure range, use 0.1 ma.
- If you are using the gauge in the UHV range, the default emission setting may not result in a large enough ion current to measure reliably. In this case, increase the emission current to the maximum setting of 10 ma. However, there will be more out-gassing which could adversely affect the system pressure. So, a compromise between the emission current setting and filament out-gassing must be made. Try to use the lowest emission current setting that provides good measurement results.



## XGS-600 Gauge Controller

---

- ❑ If you have had your gauge calibrated, it would have been done at a specific emission current. You should enter that value into the emission current setting of the XGS-600.
- ❑ The XGS-600 employs a feature that automatically changes the emission current based on the pressure that is measured. If the emission current is set to values greater than or equal to 1.1 ma, the controller applies the full value when the measured pressure is below 1.0E-5 Torr, and 1/10<sup>th</sup> of that value when the pressure is above that level. There is an algorithm to minimize hunting. However, depending upon the vacuum system, it may still be possible for the gauge to hunt for the proper emission current setting when at or near 1E-5T. This is caused by the fact that when the emission current is raised as the pressure goes down, the filament outgases at a higher rate, causing the pressure to increase a bit. Sometimes it is possible for the pressure to increase enough that the controller reduces the emission current, which eliminates the source of gas. This causes the pressure to decrease to where the controller again raises the current, and the system can get stuck in this cycle. You can defeat this by setting the emission current to 1.0 ma or less, so the XGS-600 maintains that constant emission current at all pressures.

### HFIG Smart Overpressure Protection

Hot filament ion gauges all exhibit non-linearity at high pressure such that they give readings lower than the actual pressure. For gauges that are rated up to 10 mTorr or higher, operating the BA gauge at low emission current can minimize this measurement error. Unfortunately, many applications require operating the gauge at emission currents that would result in poor measurement accuracy at high pressure, thereby compromising the ability to provide effective overpressure protection.

XGS-600 adjusts the overpressure limit based upon the emission current. When the emission current is 0.7ma or less, the gauge's full high pressure range can be used. If, however, the emission current is set to higher values, XGS-600 protects the gauge by turning off the filament at 1 mTorr. Overpressure Protection uses the same fast pressure signal that is used for fast set points, and is displayed by the *P>MAX* error message.

### Setting the Auto-ON Pressure Level

When enabling the Auto-ON feature, the XGS-600 defaults the threshold pressure to 5 mTorr. If the convection gauge is installed so that it is measuring the same high vacuum chamber as the ion gauge, this is a good value to use. However, in many applications users may want to monitor the high vacuum pump's fore-line pressure instead. In this application, the foreline may never get down as low as 5 mTorr, especially if a large volume of gas is being pumped. The XGS-600 allows you to program a threshold pressure as high as 1 Torr. When Auto-ON is being used, the gauge overprotection feature is still active to protect the high vacuum gauge.

### Helium Measurement Capability

Helium has been added to Air and Argon selections in *Gas Correction* in the *Gauge Setup* screen for roughing gauges. This selection allows the controller to read correctly when the predominant gas is helium. However, it is important to recognize the performance limitations of heat loss gauges when used with helium. These are:

- ❑ Poor performance above 200 Torr - The signal to noise ratio at this high pressure range is very small, therefore stability, resolution, and accuracy are much worse than a direct pressure gauge such as a CDG, silicon diaphragm gauge, or even a bourdoin tube. Repeatability and drift is typically several hundred Torr. Performance below 200 Torr is about the same as when measuring in air.
- ❑ The maximum cable length is about half that when measuring air or argon. The maximum recommended cable length using standard cables is 150'.
- ❑ The maximum number of rough gauge channels is reduced. Every gauge channel setup for helium is equivalent to two channels when set for air or argon. Therefore, the maximum number of convection cards, if all are set to helium, is three (six channels).

### Selection of Analog Output Response Time

The *Gauge Setup* screen now has a line for selecting between a FAST or SLOW analog output response time. When FAST is selected, the analog output response time is ~10 msec, while the SLOW selection is ~ 250 msec. The original XGS-600 release was always slow. The fast mode is useful for applications where you want to log and inspect the events that lead up to a fast set-point release or if they want to use the analog output for their own interlock purposes and bypass the XGS-600 set point outputs. When the fast response time is selected, the signal is necessarily somewhat noisier and less accurate than the slow version.

The default settings are FAST for the IMGs and SLOW for hot filament and rough gauges.

## System Setup Screen

Use this screen to set values for overall system operation.

To open this screen select **SYSTEM SETUP** on the Sensor Setup screen.

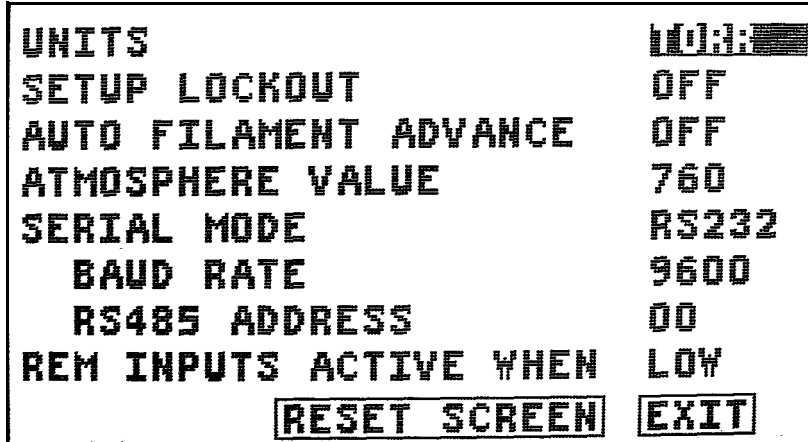

Figure 3-6 System Setup Screen

UNITS	Select: Torr (default), Pascal or mbar. Once the units are changed, the values throughout the system are updated to the new units.
SETUP LOCKOUT	Toggle this to ON to make all fields on the SYSTEM SETUP and SENSOR SETUP screen display-only (except for this field). This provides a layer of security to prevent inadvertent changes.
AUTO FILAMENT ADVANCE (HFIG Boards)	For two-filament HFIG sensors, if Auto Filament Advance is selected, Filament 2 is automatically engaged if Filament 1 has an open filament error (NO FIL1). FIL2 ON then appears on the main screen. Auto filament advance can occur when emission is first turned on or during gauge operation. Auto advance does not advance from Filament 2 to Filament 1. If an open filament error occurs on Filament 2, instead the NO FIL2 error appears and emission is turned off.

## XGS-600 Gauge Controller

---

ATMOSPHERE VALUE (Convection Boards)	Sets the Atmosphere value to be used in Convection gauge calibration. See "Main Screen" on page 3-3 for the calibration procedure.
SERIAL MODE	Select between RS232, RS485, and BCD communications.  When RS232 or RS485 is selected, the communication protocol is ASCII (see "ASCII Serial Commands" on page B-1) and the only difference being the use of either the RS232 or RS485 transceivers.  When BCD is selected, the communication is a <i>packed-BCD</i> type using only the RS232 transceiver. This protocol is described in "BCD Serial Commands" on page C-1 and is substantially backwards compatible with older Multigauge controllers running Px.x EPROMs.
SERIAL BAUD RATE	Selects between baud rate options: 9600 (default) and 19200.
RS485 ADDRESS	Set the RS485 address (default 00) as used in the first two characters of all serial protocol commands (see "ASCII Serial Commands" on page B-1).
REMOTE INPUTS ACTIVE WHEN	Use this to select either active LO (default) or active HI logic for the HFIG and IMG board on-off and degas (HFIG only) inputs. When the input is in the active state, the gauge is turned on. The active HI selection provides backwards compatibility with Multigauge and Sentorr applications. See "XGS-600 vs MultiGauge and SenTorr Backwards Compatibility Detail" on page A-9 for a description of differences.
RESET SCREEN	Select to open the Software Versions screen which includes the system reset function (page 3-17).
EXIT	Select to return to the Main Screen (page 3-3).

### Notes on Serial Communications

There are three selections for serial communications:

- RS232
- RS485
- BCD

The RS232 and RS485 modes are ASCII protocols. Refer to Appendix B "ASCII Serial Commands" for the list of commands and the command protocol. These are largely backwards compatible with Multigauge using software revisions Ax.x (ie: A2.4 for example) and all Sentorr controllers.

The pins for RS232 and RS485 are contained in the same connector housing. See Appendix A "XGS-600 Gauge Specifications" for the pin specifications.

## XGS-600 Gauge Controller

The BCD selection is a so-called *packed-BCD* protocol that was used on older Multigauge controllers using software revisions Px.x (ie: P3.3 for example).

### NOTE



*Sentorr never used the BCD protocol.*

This protocol can only use the RS232 transceiver and is intended for applications that require the XGS-600 to operate in older systems, where it is impossible to modify the system's software. While this provides enhanced backwards compatibility with most applications, due to differences between the Multigauge and XGS-600 controllers it cannot guarantee backwards compatibility with **ALL** applications. See Appendix C "BCD Serial Commands" for the list of commands and command protocols.

### Software Versions Screen

This screen shows the software versions on a board-by-board basis.

To open this screen select **RESET SCREEN** on the System Setup screen.

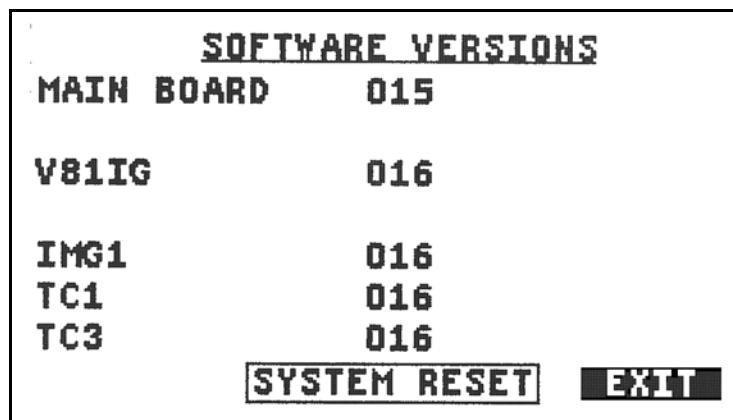

**Figure 3-7 Software Versions Screen**

SYSTEM RESET

Use this to perform a full reset of user-defined variables, reverting the system to as-shipped (factory-set) state.

EXIT

Select to return to the Main Screen (page 3-3).

## Large Font Screen

To open this screen select **LARGER** on the Main screen.

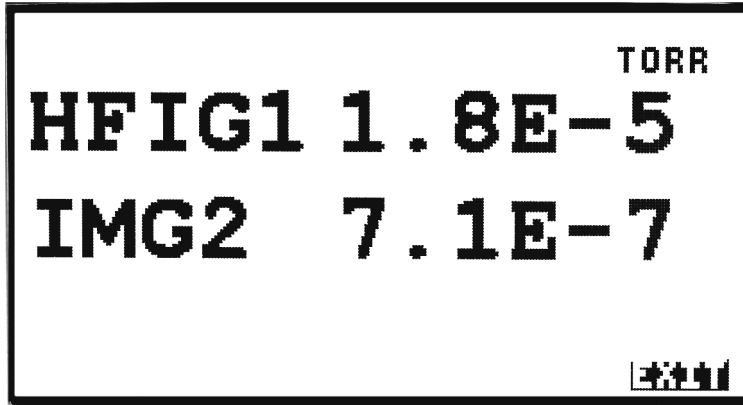

**Figure 3-8 Large Font Screen**

The leftmost column shows the User Label as configured on the Sensor Setup screen. You can select which transducers appear on this screen by moving the cursor to the User Label and using the +/- modify keys.

EXIT                      Select to return to the Main Screen (page 3-3).

# XGS-600 Gauge Controller

## Auto-On Feature Activation Procedures

1. Use Arrows to highlight setup and press OK:

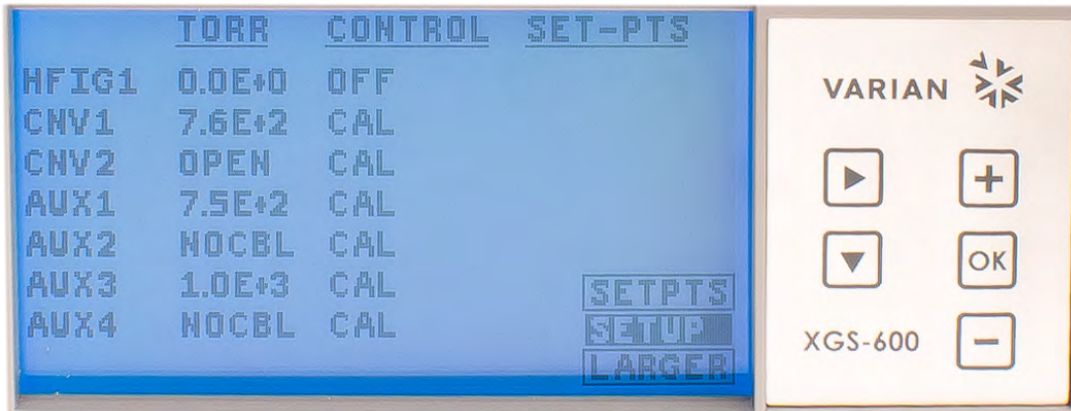

2. Use Arrow down button to highlight sensor ID:

A. Use + or - button to change which sensor to use Auto-On with  
**NOTE:** Only HFIG and IMG gauges can be set with this function.

B. Press OK once you have selected which HFIG or IMG gauge to turn on automatically.

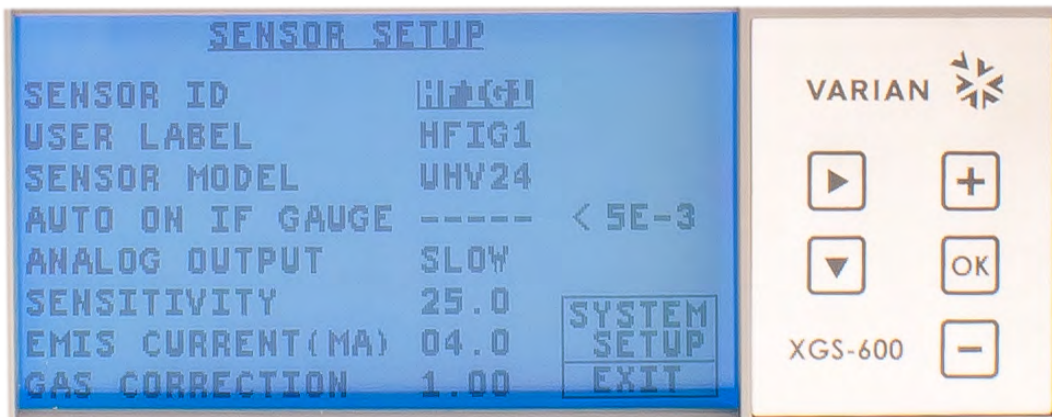

## XGS-600 Gauge Controller

3. Use Arrow button to scroll down and highlight the AUTO ON IF GAUGE ----- <1E-3.

A. Use + or - buttons to select which sensor to use as a setpoint for the auto on feature.

**NOTE:** When the analog board is installed, any of the active type gauges, or CDG, can be used to turn on/off an Ion Gauge.

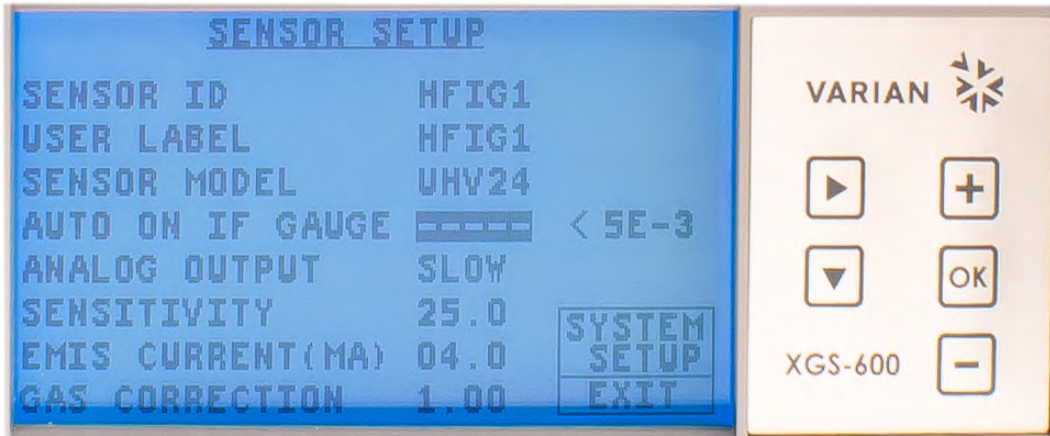

B. When sensor has been chosen, press the OK Button.

C. You now have the option to change the vacuum setpoint on which the HFIG turns on.

D. Press OK.

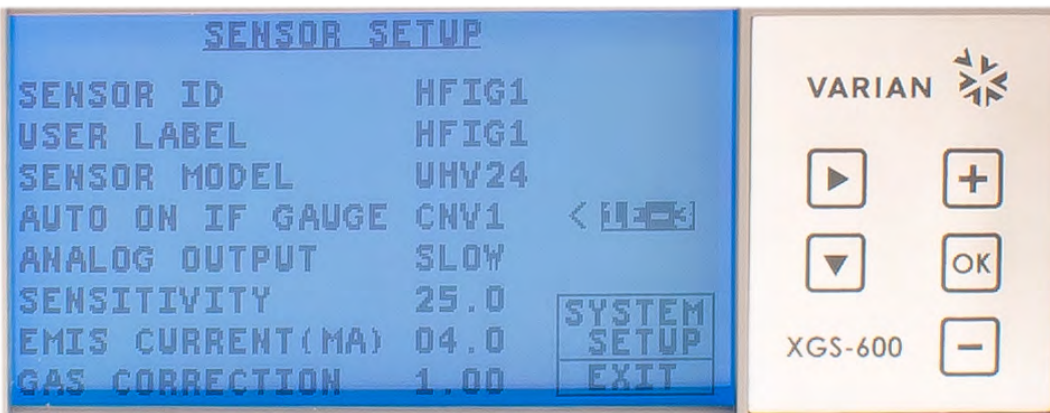

4. Use the button and highlight the EXIT and press OK.

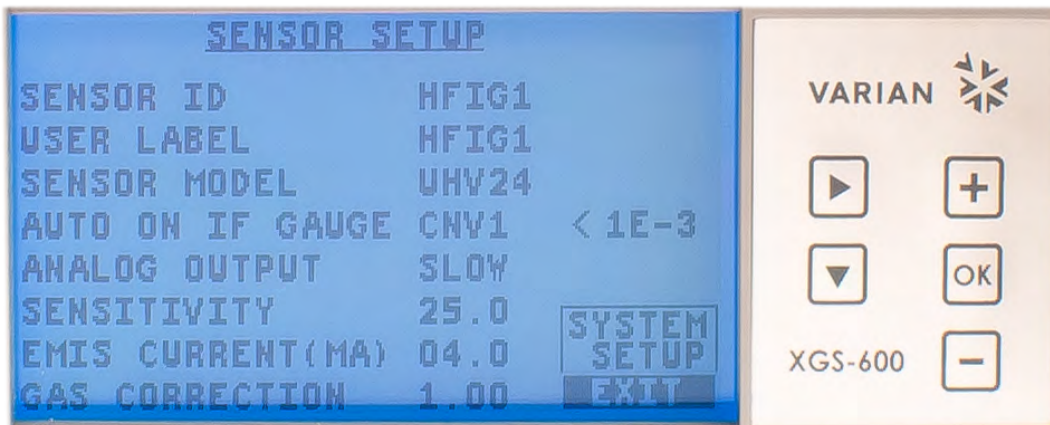



## Chapter 4: Service and Troubleshooting

It is possible to replace sensor boards in the field for repair or to change the unit's configuration to meet new application requirements. Because the slot spacing is different for slots 5 & 6, you must follow the instructions below when installing the sensor boards.

### Board Configuration Rules

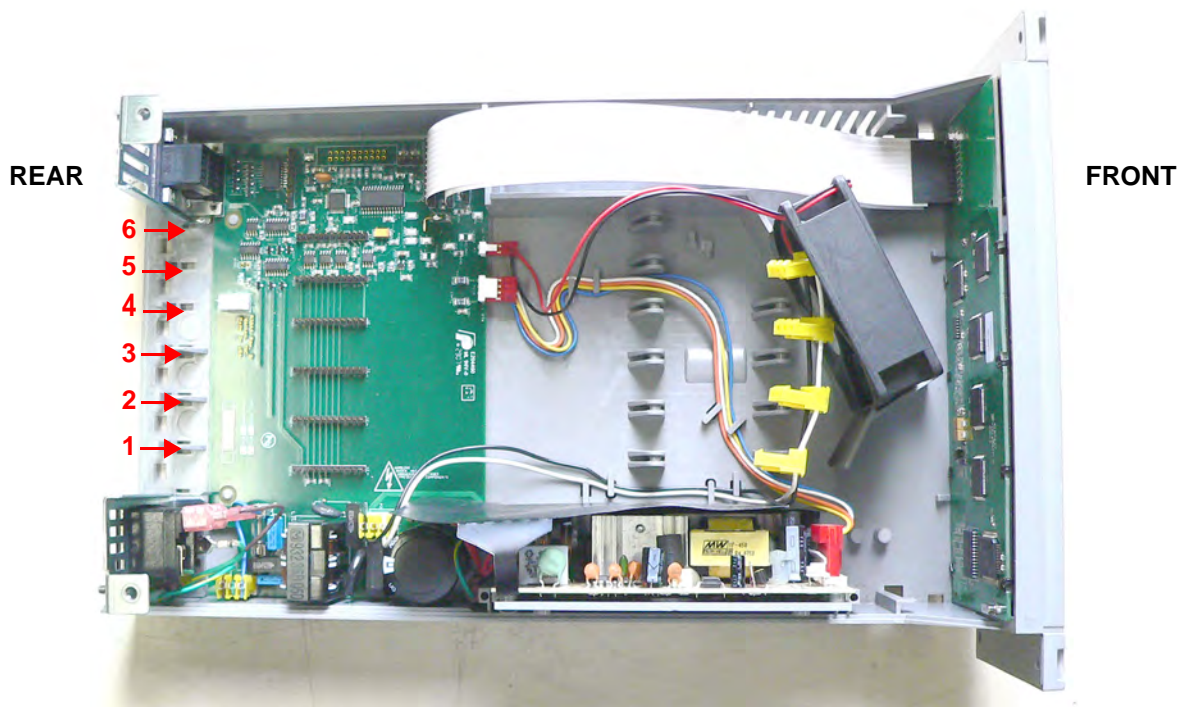

**Figure 4-1 XGS-600 Slot Numbers**

- ❑ Slots are numbered from left to right as viewed from the front of the XGS-600.
- ❑ Option slots 1 through 4 are "Long, High Profile Slots" and can accommodate any board. HFIG boards are "Long, High Profile" boards and can only be installed in slots 1 through 4.
- ❑ Option slots 5 and 6 are "Short, Low Profile" slots and can accommodate only convection or IMG boards, with the following restrictions:
  - An IMG board may NOT be installed in slot 5 if any other board is installed in slot 4.
  - An IMG board may NOT be installed in slot 6 if any other board is installed in slot 5.

## XGS-600 Gauge Controller

---

*Examples:*

- ❑ You want to install 5 IMG boards:
  - IMG boards are installed into slots 1, 2, 3, 4, and 6. Slot 5 remains empty. Do not install any board into slot 5.
- ❑ You want to install 4 IMG and 2 CNV boards:
  - IMG boards are installed in slots 1, 2, 3, and 4; CNV boards are installed in slots 5 and 6.

### Sensor Board Replacement Procedure

**WARNING**



*Only trained service personnel should attempt this work. Disconnect the XGS-600 mains connection by unplugging the IEC power cord from the back of the unit before removing the unit's cover.*

**CAUTION**



*Wear an ESD bracelet and observe all appropriate precautions to avoid damage to PCBs.*

**CAUTION**



*When these boards are assembled certain components are bent over intentionally. Do not straighten them.*

1. Turn off and unplug the line cord (AC mains).
2. Remove the cover by unscrewing the two Philips head screws.
3. If removing an HFIG board, unplug the yellow connector near the front panel. It may require some effort to unplug. Do not pull on the wires, pry the yellow plastic connector instead.

## XGS-600 Gauge Controller

- Lift the sensor board by the tab at the rear panel (Figure 4-2). Once the board is disengaged from the board connector, pull the board out of the end guide.

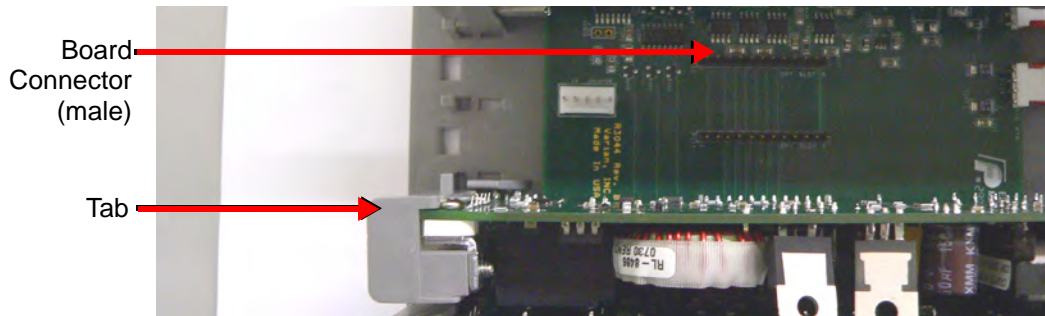

**Figure 4-2 Tab and Main Board Connector**

### WARNING



*To ensure safety and proper operation, no slot opening can be left unfilled. Install a filler plate by installing the two hooks into the case bottom and snapping in the foot. Contact Varian if additional fillers are needed.*

- Install the replacement board:
  - Place the end of the board into the end guide (Figure 4-3).

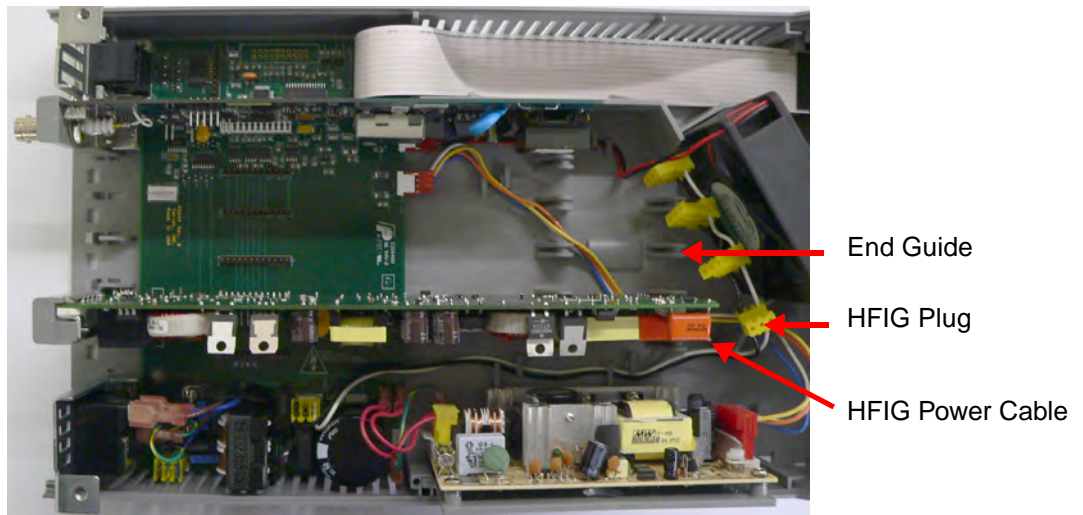

**Figure 4-3 End Guide and HFIG Connector**

- Guide the board down as straight as possible onto the connector on the main board. Figure 4-4 shows the connector on the base of all three board types.

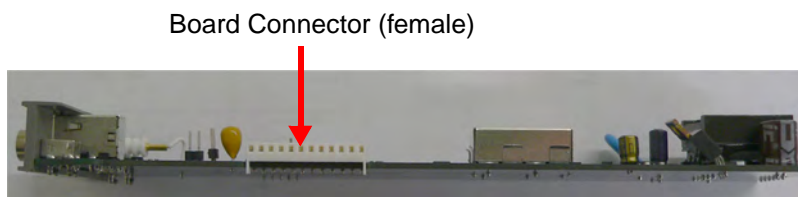

**Figure 4-4 Sensor Board Connector: Bottom View**

## XGS-600 Gauge Controller

---

- c. Locate the rear panel portion of the board into its slot, press down the tab and exert gentle pressure until it clicks into place.

**CAUTION**



*Do not force the board down. If too much pressure is required the connector pins are not aligned.*

- d. Insert the yellow HFIG plug into the connector (HFIG boards only). See Figure 4-3. This connector is keyed.
  - e. Inspect the installation to ensure the board is seated properly and not touching any adjacent boards.
6. Replace the covers:
    - a. Push the cover straight in under the lip at the XGS front bezel.
    - b. Replace the two Phillips head screws.
    - c. The cover must be flat and fully seated. It may be necessary to adjust the boards and filler plates slightly for the cover to fully engage. The cover should drop on front of the filler plate.
  7. Plug the unit back in and turn on the power switch.

**NOTE**



*Any board-specific settings must be reprogrammed.*

*Most Sensor setup and Set point user settings stay with the board. This means if the removed board is used elsewhere, most settings will be saved. However, if a new board is installed, you will have to reprogram the settings.*

## Troubleshooting

### Error Codes

Table 4-1 General Error Code

Error Message	Meaning	Cause	Action
<i>BD COM</i>	Board Comm: Internal communication error	Motherboard and sensor board stopped communicating	1. Cycle power to unit 2. Return unit for repair
<i>GRIDLO</i> ( <i>HFIG bds only</i> )	Grid voltage is too low	<input type="checkbox"/> Pressure is too high causing a glow discharge <input type="checkbox"/> HFIG board failure	1. Check BA gauge for grid to filament short or grid to housing short 2. Replace gauge
<i>HITEMP</i> ( <i>HFIG and IMG bds only</i> )	Internal temperature is above 75° C	<input type="checkbox"/> Fan failure <input type="checkbox"/> XGS ventilation openings blocked <input type="checkbox"/> Internal temperature above 75° C	1. Allow unit to cool 2. Check that fan is operating 3. Ensure that there is adequate ventilation around the unit
<i>NOFIL1</i> ( <i>HFIG bds only</i> )	Filament is open or cable disconnected	<input type="checkbox"/> Filament failure <input type="checkbox"/> Ion gauge cable not connected	1. Use second filament 2. Replace BA gauge 3. Check that cable is installed
<i>NOFIL2</i> ( <i>HFIG bds only</i> )	Second filament is open or cable disconnected	<input type="checkbox"/> Filament failure <input type="checkbox"/> Ion gauge cable not connected	1. Replace BA gauge 2. Check internal sensor board connections 3. Check that cable is plugged in
<i>Open</i> ( <i>CNV bds only</i> )	No Convection sensor detected	<input type="checkbox"/> Cable not connected <input type="checkbox"/> Sensor failure	1. Check cable 2. Replace sensor
<i>P&gt;MAX</i> ( <i>HFIG bds only</i> )	Pressure is above the maximum operating point for the gauge	<input type="checkbox"/> System vented from vacuum with gauges on <input type="checkbox"/> Attempted to turn gauges on with vacuum near overpressure limit	1. Turn gauges off before venting system or use AUTO-ON 2. Wait for vacuum to improve before turning on ion gauges

## XGS-600 Gauge Controller

### Tips

Varian offers reference ionization B/A gauges, which are sealed off at approximately  $5E-6$  Torr/ $6.6E-4$  Pa, as well as a Convection gauge simulator which can switch between atmosphere and vacuum simulation. These devices are extremely helpful in troubleshooting a vacuum system problem by isolating the defective component.



*These reference gauges and stimulators are not NIST traceable calibrated gauges, and should not be used for calibration.*

### Troubleshooting Table

**Table 4-2 Troubleshooting**

Problem	Cause	Action
Hot filament gauge <i>hunts</i> or <i>cycles</i> around $1E-5$ Torr ( $1E-3$ Pa)	Auto emission adjustment occurs at this pressure. Increased filament power causes a rise in pressure. Condition will clear as system pressure decreases.	If taking pressure measurements in this range, reduce emission current setting for the gauge to 1.0 mA or less to turn off feature
IMG displays readings in the $-11$ Torr range when the pressure is known to be higher Sometimes after a long time period the reading becomes correct	<input type="checkbox"/> IMG cable not plugged in <input type="checkbox"/> IMG has not started <input type="checkbox"/> IMG took a long time to start	1. Check that cable is attached 2. Sometimes IMG's are hard to start when turned on at high vacuum 3. Raise pressure 4. Clean or replace IMG
HFIG bd reads UHV when pressure is know to be higher	<input type="checkbox"/> Emission current not established due to worn out Th-Ir filament <input type="checkbox"/> Collector cable unplugged <input type="checkbox"/> HFIG board failure	1. Check collector connection at gauge (glass BA) and at XGS-600 2. Replace gauge or filament 3. Return unit for repair/replace HFIG bd
<i>ERR</i> appears in rightmost column of setpoint screen	Setpoint OFF pressure is < than ON pressure	Correct pressure entries so the setpoint ON pressure is less than the OFF pressure
<i>Duplicate</i> message appears when trying to enter a User Label	<input type="checkbox"/> Label is the same as another User Label	Create a different entry
User Label not accepted	<input type="checkbox"/> User input violates User Label rules	See "Sensor Setup Screen" on page 3-9 for User Label rules

## XGS-600 Gauge Controller

**Table 4-2 Troubleshooting (Continued)**

Problem	Cause	Action
Cannot turn HFIG or IMG on using the keypad	<ul style="list-style-type: none"> <li><input type="checkbox"/> Auto-ON programmed for that gauge</li> <li><input type="checkbox"/> The keypad is locked out</li> </ul>	<ol style="list-style-type: none"> <li>1. This is the correct response</li> <li>2. If manual control is desired, turn off AUTO-ON</li> <li>3. Unlock keypad</li> </ol>
Cannot turn on Degas	<ol style="list-style-type: none"> <li>1. Pressure is above 1E-5T</li> <li>2. Attempted to turn on Degas2 while running Fil1</li> <li>3. Attempted to degas third gauge</li> </ol>	<ol style="list-style-type: none"> <li>1. Pump down before degas</li> <li>2. Change operation to Fil2 before attempting to degas that filament</li> <li>3. XGS-600 will only degas two gauges at a time</li> <li>4. Finish a degas before attempting to start a third</li> </ol>
The front panel display indicates the setpoint triggers/releases at a slightly different pressure than what is programmed	Time delay = 0.0, 0.1	XGS-600 uses a less accurate pressure measurement for setpoint delays of $\leq 0.1$ secs to obtain fastest responsiveness
Changes to baud rate, comm. mode, units, keypad lockout, or ATM value do not take effect	Did not exit System Setup screen after making changes	After making changes, exit the screen for the changes to take effect
Unit does not respond to RS232 or RS485 commands	<ol style="list-style-type: none"> <li>1. XGS600 in wrong serial mode or incorrect baud rate</li> <li>2. Incorrect wiring</li> <li>3. Incorrect terminal settings</li> </ol>	<ol style="list-style-type: none"> <li>1. Change serial comm to RS232 or RS485, select proper baud rate, set RS485 address in <i>General Setup</i> screen</li> <li>2. Check wiring</li> <li>3. Check that terminal has correct # of data, start/stop bits, etc.</li> </ol>
Display goes blank followed by a refill of the screen. Operation is otherwise normal.	Screen refreshes approximately every 20 minutes	XGS-600 refreshes the entire screen periodically to update. No action required.
One or more ion gauge channels (HFIG and IMG) appear to restart, sometimes a <i>BDCOMM</i> message appears first	A major EMI disturbance or other anomaly has caused a sensor board watchdog timeout	This is how the XGS-600 recovers from hard and soft errors. No action required.
<i>BDCOMM</i> message appears on one or more channels and stays	A major EMI disturbance or other anomaly has caused a non-recoverable software error	Cycle AC (mains) power to the unit OFF and ON again to recover

## XGS-600 Gauge Controller

**Table 4-2 Troubleshooting (Continued)**

<b>Problem</b>	<b>Cause</b>	<b>Action</b>
IMG reads 10 mT	Pressure is greater than 10 mT	Wait for pressure to drop into operating range or use Auto-On feature to control IMG
Display goes blank	A major EMI has caused a display or software error	Cycle AC (mains) power to the unit OFF and ON again to recover, or wait for the automatic screen refresh (every 20 minutes)
Convection or TC readings fluctuate when first at HI VAC but then quiet down	This is normal behavior of the Convectorr and TC gauges when doing a pumpdown.	None
Convection or TC readings fluctuate in excess of 1 mT continuously when at Hi VAC	Possible defective gauge.	Replace gauge
Convection or TC readings unstable at atmosphere when measuring Helium	This is normal performance for thermal loss gauges in helium	Refer to "Helium Measurement Capability" on page 3-14 for performance limits when measuring helium



# Appendix A. XGS-600 Gauge Specifications

## Instrument Specifications

Table A-1 provides the XGS-600 instrument specifications.

**Table A-1 General XGS-600 Gauge Specifications**

Specification	Description
Display	Type: Backlit dot matrix monochrome LCD Backlight: White LED Small Font mode: Up to 8 channels displayed simultaneously Large Font mode: Up to 2 channels displayed, readable from 15 feet
Keypad	5 button membrane with positive tactile feedback
Serial Communication	ASCII protocol: RS232 and RS485, no parity BCD protocol: RS232 RS485 address range: 00 - FF Baud Rate: 9600 or 19600
Set-Point Outputs	Type: 8 open collector type, ground referenced outputs Voltage Rating: 32 VDC max Current Rating: 50 mA max Output Voltage: $V_{out} 50 \text{ Gnd}$ $V_{on} @ 5 \text{ mA} = 0.6 V_{max}$ $V_{on} @ 25 \text{ mA} = 0.75 V_{max}$ $V_{on} @ 50 \text{ mA} = 0.90 \text{ V}$ Programming capability: Can assign up to 2 outputs per gauge channel Separate "make" and "break" pressure levels Independent time delays on "make" and "break" of 0.0 to 9.9 seconds Manual override capability of each set point output Response Time: 20 msec max (when delay = 0.0)
Chassis	Dimensions: ½ rack, 2U high, 11" deep Material: Grey Polycarbonate Ventilation: Internal fan with plenum and over-temperature sensing
Fuse Rating	5A Fast Blow

## XGS-600 Gauge Controller

**Table A-1 General XGS-600 Gauge Specifications (Continued)**

Specification	Description
Mains Power and Cordage	Voltage: 100-120, 200-240 VAC $\pm$ 10% 50/60 HZ, 2A Available worldwide IEC cords
Environmental/Installation	Storage Temperature: -15 to 70° C Operating Temperature: CSA certified 5 to 40° C, at 5 to 95% RH, non-condensing Installation Category: 2 Pollution Degree: 2 Indoor use Altitude: Up to 2000 m
Regulatory Approval	CE Certified: Safety: EN61010 Emissions: EN6100-3-2 : 2006 EN6100-3-2 : 2005 EN61326: 1997/A1: 1998/A2: 2001/A3: 2003 EN55011 FCC Part 15 subpart J Certified to CSA1010 for US and Canada RoHS Compliant WEEE labeled

## Board Specifications/Descriptions

### HFIG Board

The HFIG board operates all Varian hot filament gauges and most other available Bayard-Alpert type hot filament ionization gauges including nude UHV types. The board can be set up for all Varian hot filament gauges and allows you to set gauge emission current, sensitivity value, and gas correction factor. The UHV range and E-Beam degas are standard, as is dual filament control, remote I/O control of emission and filament selection, and 0 to 10 V analog output.

**Table A-2 HFIG Gauge Specifications**

Item	Description
Supported Gauge Heads	<input type="checkbox"/> Varian 563, 564, 571, 572, UHV24, UHV24p, MBA-100, MBA-200
Displayed Measurement Range*	<input type="checkbox"/> 5.0E-12 Torr to 1 mTorr (UHV24, UHV24p, 572) <input type="checkbox"/> 5.0E-11 Torr to 10 mTorr (563, 571, MBA100, MBA200) * This represents the ability of the controller to display pressure values and not the capability of the gauge heads to accurately measure pressure.
Emission Current	0.1 to 10.0 mA
Sensitivity Input Range	00.1 to 99.9/Torr
Gas Correction Factor Range	0.01 to 9.99
Degas	E-Beam type, 600 V at 10 mA, enabled only when pressure is below 1.0E-05 Torr. Pressure indications displayed during degas. Automatic shutoff after approximately 25 minutes, or manual shutoff.
Analog Output	<input type="checkbox"/> Range: 0-10 VDC <input type="checkbox"/> Slope: 1 V per decade log <input type="checkbox"/> Characteristic: output voltage = Log (Pressure) + 11 <input type="checkbox"/> Output when gauge OFF or Error = 10V <input type="checkbox"/> Load Impedance: >10 kOhms <input type="checkbox"/> Response Time: <input type="checkbox"/> SLOW - 250 msec <input type="checkbox"/> FAST - 10 msec
Error Detection	<input type="checkbox"/> Open Filament <input type="checkbox"/> Shorted Grid <input type="checkbox"/> Over Temperature <input type="checkbox"/> Over Pressure (1mT or 10mT dependant on tube type selected)
Gauge Connector	<input type="checkbox"/> Collector: SMB coax <input type="checkbox"/> Fil and Grid: AMP 5 pos Univ Mate-N-Lok

## XGS-600 Gauge Controller

**Table A-2 HFIG Gauge Specifications**

Item	Description
Remote I/O	<ul style="list-style-type: none"> <li><input type="checkbox"/> Connector: 6 pin IEEE 1394 (Firewire type)</li> <li><input type="checkbox"/> Inputs for Emission on/off and DEGAS on/off are user selectable to be either Active LO or Active HI. Driving the input to the active state turns on that function.                             <ul style="list-style-type: none"> <li><input type="checkbox"/> HI = +5 V max, 2.4 V min</li> <li><input type="checkbox"/> LO = 0.8 V max, 0 V min</li> </ul> </li> <li><input type="checkbox"/> Filament Select input: Pin 1 open or driven HI selects Fil1. Pin 1 grounded selects Fil2.</li> <li><input type="checkbox"/> Status Output goes HI during error condition</li> <li><input type="checkbox"/> Analog Output</li> </ul>
Allowable Cable Length	<ul style="list-style-type: none"> <li><input type="checkbox"/> up to 50' using Varian standard cable</li> <li><input type="checkbox"/> up to 300' using under 10' Varian standard cable + Varian extension cable</li> </ul>

### Convection Gauge Board

The Convection card operates two Thermocouple/Convection gauges and allows you to calibrate:

- To the actual atmospheric pressure value,
- To vacuum pressure,
- and select calibration for air or argon.

Calibration is Varian's *Smart Cal* that determines whether a CAL command is for vacuum or atmosphere. Remote control of calibration and analog output is standard. Each channel has its own 9-pin Dsub connector.

**Table A-3 Convection Board Specifications**

Item	Description
Supported Gauge Heads	Varian Model, 536, 531, and ConvecTorr
Displayed Measurement Range	1.0E-4 Torr to 1000 Torr
Gas Types	Air, Argon or Helium (see "Helium Measurement Capability" on page 3-14)
Atmosphere Value Range	500 to 1000 Torr

## XGS-600 Gauge Controller

**Table A-3 Convection Board Specifications**

Item	Description
Analog Output	<input type="checkbox"/> Range: 0-10 VDC <input type="checkbox"/> Slope: 1 V per decade log <input type="checkbox"/> Characteristic: output voltage = Log (Pressure) + 5 <input type="checkbox"/> Output when gauge OFF or Error = 10 V <input type="checkbox"/> Load Impedance: >10 kOhms <input type="checkbox"/> Response Time: <input type="checkbox"/> SLOW - 250 msec <input type="checkbox"/> FAST - 10 msec
Error Detection	Open cable/sensor
Gauge Connector	Dsub9
Remote I/O Connector	6 pin Firewire type Grounding the input pin activates that function The Status Output goes hi during an error. Note: the analog outputs for CNV1 and CNV2 are also available at pin 7 of their respective Dsub connectors.
Allowable Cable Length	<input type="checkbox"/> Air/Argon - up to 300 ' using Varian TC or Convectorr cable <input type="checkbox"/> Helium - up to 150' using Varian TC or Convectorr cable

### IMG Board

The IMG board operates Varian IMG-100 and IMG-300 gauges and allows you to set gauge sensitivity value, and gas correction factor. The UHV range is standard, as is remote I/O control of emission and 0 to 10 V analog output.

**Table A-4 IMG Board Specifications**

Item	Description
Supported Gauge Heads	Varian IMG-100, IMG-300
Measurement Range*	1.0E-12 to 1.0E-02 Torr * (or equiv mbar and Pa) * This represents the ability of the controller to display pressure values and not the capability of the gauge heads to accurately measure pressure.
Sensitivity Input Range	00.1 to 99.9
Gas Correction Factor Range	0.1 to 9.9

## XGS-600 Gauge Controller

**Table A-4 IMG Board Specifications (Continued)**

Item	Description
Analog Output	<ul style="list-style-type: none"> <li><input type="checkbox"/> Range: 0-10 VDC</li> <li><input type="checkbox"/> Slope: 1 V per decade log</li> <li><input type="checkbox"/> Characteristic: output voltage = Log (Pressure) + 11</li> <li><input type="checkbox"/> Output when gauge OFF or Error = 10 V</li> <li><input type="checkbox"/> Load Impedance: &gt;10 kOhms</li> <li><input type="checkbox"/> Response Time:                             <ul style="list-style-type: none"> <li><input type="checkbox"/> SLOW - 250 msec</li> <li><input type="checkbox"/> FAST - 10 msec</li> </ul> </li> </ul>
Error Detection	Over Temperature
Gauge Connector	SHV
Remote I/O Connector	<ul style="list-style-type: none"> <li><input type="checkbox"/> Connector: 6 pin IEEE 1394 (Firewire type)</li> <li><input type="checkbox"/> Input for Emission on/off is user selectable to be either Active LO or Active HI. Driving the input to the active state will turn on the gauge.                             <ul style="list-style-type: none"> <li><input type="checkbox"/> HI = +5 V max, 2.4 V min</li> <li><input type="checkbox"/> LO = 0.8 V max, 0 V min</li> </ul> </li> <li><input type="checkbox"/> Status Output goes HI during error condition</li> <li><input type="checkbox"/> Analog Output</li> </ul>
Allowable Cable Length	up to 300' using RG59U

## I/O Pin Assignments

Table A-5 through Table A-9 give the I/O pin assignments for the various boards and connectors.

**Table A-5 IMG Board I/O Pin Assignments**

Function	Pin # (J26)
EMIS ON	6
ANALOG OUT	5
STATUS OUT	4
GND	2 + Shield
-	1
-	3

## XGS-600 Gauge Controller

**Table A-6 HFIG Board I/O Pin Assignments**

Function	Pin # (J26)
EMIS ON	6
ANALOG OUT	5
STATUS OUT	4
GND	2 + Shield
FIL 2 SELECT INPUT	1
DEGAS ON INPUT	3

**Table A-7 Convection Board I/O Pin Assignments**

Function	Pin # (J1)
TC1 ANALOG OUT	5
TC2 ANALOG OUT	3
EXT TC1 CAL IN	1
EXT TC2 CAL IN	6
STATUS OUT	4
GND	2 + Shield

**Table A-8 Set-Point Connector Pin Assignments**

Function	Pin #
GND	1
SET POINT 1 OUTPUT	2
SET POINT 2 OUTPUT	3
SET POINT 3 OUTPUT	4
SET POINT 4 OUTPUT	5
SET POINT 5 OUTPUT	6
SET POINT 6 OUTPUT	7
SET POINT 7 OUTPUT	8
SET POINT 8 OUTPUT	9

## XGS-600 Gauge Controller

---

**Table A-9 Serial Connector Pin Assignments**

<b>Function</b>	<b>Pin #</b>
+RS485 XFD (DIFF INPUT/OUTPUT)	1
TXD OUTPUT RS232	2
RXD INPUT RS232	3
NOT USED	4
GND	5
NOT USED	6
NOT USED	7
RTS OUTPUT RS232	8
-RS485 XFD (DIFF INPUT/OUTPUT)	9



# XGS-600 vs MultiGauge and SenTorr Backwards Compatibility Detail

XGS-600 replaces both MultiGauge and SenTorr rack mount controllers. While the XGS-600 was designed to be substantially backwards compatible, there are some design features that prevent the new product from being 100% backwards compatible.

### Backwards Compatible Features

There are three board options, they are:

- Hot Filament Ion Gauge Board (HFIG)
- Inverted Magnetron Board (IMG)
- Two channel Convection Board (CONV)

The *Hot Filament board* replaces both the UHV and BA MultiGauge boards and implements the SenTorr BA and UHV models. You select the type of sensor being employed and software takes care of the settings. The ion gauge cable connectors are identical to the older products.

The *Inverted Magnetron* board employs the same SHV connector as MultiGauge and operates both of the IMG100 and the IMG300 (UHV-IMG) as does the current MultiGauge board.

The *Two Channel Convection board* has the same gauge cable connectors as the current MultiGauge Convection card, and the SenTorr xxTC and xx2C models. MultiGauge uses the Dsub connector for the analog output, as well as for the sensor connections, and this is supported in XGS-600.

The RS232 serial communications connector and protocol is supported in XGS-600, as well. However, the RS485 connection is now housed in the same Dsub-9 connector as for the RS232, and is not backwards compatible with the MultiGauge and SenTorr Mini-DIN connectors.

### Non-Backwards Compatible Features

The significant changes with the XGS-600 vs MultiGauge and SenTorr are the following:

- XGS-600 does not have a 4 channel TC card (MG)
- The analog outputs are housed in a firewire type connector (as mentioned above, the two channel Convection board has its analog outputs in the Dsub's as well)
- Remote I/O signals are also housed in the same fire-wire connector. There is no I/O board option as in MultiGauge
- The standard non-isolated open-collector set-point outputs are housed in a 9-position Dsub connector. All eight NO outputs share a single ground connected common pin. MultiGauge and SenTorr provide true isolated relay outputs with

## XGS-600 Gauge Controller

access to C, NC and NO contacts. SenTorr uses terminal block connectors while MultiGauge uses a 25-position Dsub.

- ❑ XGS-600 is not available in a *Black Box* version with a remote mountable display.

Table A-10 list the features compatible for the MultiGauge and SenTorr units.

**Table A-10 Feature Compatibility Table**

Feature	XGS-600	MultiGauge	SenTorr BA or UHV	SenTorr CC
Hot Filament Gauges	All	All	All	n/a
Cold Cathode Gauges	IMG100 IMG300 (UHV-IMG)	IMG100 UHV-IMG 525CCG	n/a	525CCG
Convection Gauges	2 ch Convection Bd using (2) Dsub9	4 ch TC Bd using Dsub37  2 ch ConvecTorr Bd using (2) Dsub9	2 ch ConvecTorr using (2) Dsub9  2 ch TC	2 ch ConvecTorr using (2) Dsub9  2 ch TC
CDG's	Not supported	(2) Dual Ch CDG Bds	n/a	n/a
Rem I/O	Uses Fire-wire conn on each board  Emission/degas control inputs can be user selected to be active LO (default) or active HI. CNV CAL inputs are active LO. Logic levels are std TTL logic, +5V max input.	Needs optional Remote I/O Bd using Dsub37  Uses opto-isolated active HI inputs 32V max	Micro phone jack for IG control  Uses opto-isolated active HI inputs 32V max	Micro phone jack for IG control  Uses opto-isolated active HI inputs 32V max
Analog Output	In Fire-wire conn of each Bd  Conv Bd also provides access pin in Dsub9	Micro phone jack on each Bd  2ch and 4ch Conv bds provide access in Dsub conn	Micro phone jack	Micro phone jack
Set Points	Std 8 setpoints, 2 per ch using open collector drivers in Dsub9	Optional 8 setpoints using relays using Dsub25, access to C,NO,NC contacts	Optional 4 setpoints using relays using term block type conn, access to C,NO,NC contacts	Optional 4 setpoints using relays using term block type conn, access to C,NO,NC contacts

## XGS-600 Gauge Controller

**Table A-10 Feature Compatibility Table (Continued)**

Feature	XGS-600	MultiGauge	SenTorr BA or UHV	SenTorr CC
RS232	Std Dsub9 IBM pinout, supports MG protocol	Opt Dsub9, IBM pinout	Opt Dsub9, IBM pinout	Opt Dsub9, IBM pinout
RS485	Std in Dsub9, supports MG protocol	Opt with choice of daisy chain using MiniDIN or Dsub9	Opt with choice of daisy chain using MiniDIN or Dsub9	Opt with choice of daisy chain using MiniDIN or Dsub9
BCD (RS232)	Supports older MG Px.x serial protocol applications	Px.x EPROMs	N/A	N/A
<i>Black Box</i> and Remote Display option	No	No	Yes	Yes

Table A-11 list the cable compatibility for the MultiGauge and SenTorr units.

**Table A-11 Cable Compatibility Table**

Cable	XGS-600	MultiGauge	SenTorr BA or UHV	SenTorr CC
UHV Bakeable L6440	Yes	Yes	Yes	N/A
UHV non-bakeable L6441	Yes	Yes	Yes	N/A
Glass BA L6455	Yes	Yes	Yes	N/A
Ion Gauge Extension L6456	Yes	Yes	Yes	N/A
525 CCG L5671*	No	Yes	n/a	Yes
IMG R0341, R0311	Yes	Yes	n/a	No
MBA R1172	Yes	Yes	Yes	n/a
Quad/Dual TC L6475*	No	Yes	No	No
Single TC L9131	Yes	Yes	Yes	Yes
Single Conv L9122	Yes	Yes	Yes	Yes
CDG L9153	No	Yes	No	No

\* Adapters are available

## XGS-600 Gauge Controller

---

*This page intentionally left blank.*

## Appendix B. ASCII Serial Commands

Response to serial command inquiries approximately 10 ms, response time defined as time between receipt of last query character to transmission of first response character. Serial queries more frequent than 10 per second will compromise system responsiveness.

### Command Syntax and Definitions

The command format is:

# {XGS-600 address} {command number} {optional data} {carriage return}

The response format is:

> {optional data} {carriage return}

The following characters are used in Table B-1:

Command	Description	Notes
#		All commands to the XGS-600 must begin with the character #.
aa	RS485 Address	=00 for RS232 (system default). Max allowable: 20hex
01	Command Number	Each command is identified by a unique command number, 2 hex digits, 01-FF.
c	Sensor Code	=U, signifies User Label is to follow.
n	User Labels	As found on Sensor Setup screen. Examples: #00B0UION4UGATE3.2E-03 sets AUTO-ON for ion gauge <i>ION4</i> using CNV gauge <i>GATE</i> . #0030UGATE1 turns on emissions of sensor User Label Gate1. #0055UTOP26.00 sets sensitivity for ion gauge with User Label Top. <b>Note:</b> If User Label is not defined by user, default User Label is Sensor ID.
<b>Note:</b> Alternatively, <i>cn</i> can be used to designate a short code instead of User Label, backward compatible to Multi-Gauge/SenTorr protocol; see separate instructions below (Table B-1 on page B-2)		
h	Hex Digit	Used to identify setpoint number or to list status of 8 bits.

## XGS-600 Gauge Controller

Command	Description	Notes
x	Data Digit	
< CR >	Termination	All commands sent to the XGS-600 require < CR > termination. < LF > is ignored so it is possible to use < CR/LF > with RS232 but not with RS485 as it would cause a collision with the response. Please note that time to response is extremely quick (10 to 20 ms) so be ready! Responses are also terminated with < CR >.

The XGS-600 sends *?FF* as a response if the command or data is invalid, or if the command length is incorrect. There is no response to a wrong address, or lack of termination character.

**Table B-1 Serial Command Set**

Description	Command	Response from XGS-600	Notes
Read XGS contents	#aa01	>hhhhhhhhhh where <i>hh</i> sensor board codes are: 10 = Hot Filament Ion Gauge board (HFIG) 3A = Inverted Magnetron board (IMG) 40 = convection board (CNV) FE = Empty slot	Lists two-character codes identifying the 6 board slots in the system, following board installation sequence from left to right (front view).
Read pressure	#aa02cn	>x.xxxE-xx	
Read software revision	#aa05	>hhhh,hhhh . . . where <i>hhhh</i> represents revision hh.hh	Revisions shown for main board, then each sensor board following board installation sequence from left to right (front view).
System Reset	#aa06	>	
Read Pressure Dump	#aa0F	>x.xxxE-xx,x.xxxE-xx, . . .	All sensor readings in one command. Readings follow board installation sequence from left to right (front view).

## XGS-600 Gauge Controller

**Table B-1 Serial Command Set (Continued)**

Description	Command	Response from XGS-600	Notes
Set pressure units to Torr	#aa10	>	
Set pressure units to mBar	#aa11	>	
Set pressure units to Pascal	#aa12	>	
Read pressure units	#aa13	>xx where: xx = 00 is Torr xx = 01 is mBar xx = 02 is Pascal	
Assign User Label to Sensor	#aa14cnLABEL where c sensor code =I for ion gauges HFIG and IMG =T for CNVs n = Sensor Count counting TCs or ion gauges from left to right from the front panel view. LABEL= user-defined 1-5 characters.	>	Label can be any 5 or fewer characters (AHZ, 0-9, or space), except for IMGxx, HFIGx and CNVxxx, (where x is any character) which are reserved.
Read User Label of Sensor	#aa15cn	>LABEL where LABEL is user-defined 1-5 characters.	If no User Label is assigned, defaults to system-assigned Sensor ID.
Setup Lockout OFF	#aa20	>	
Setup Lockout ON	#aa21	>	
Read Setup Lockout status	#aa22	>xx where: xx = 00 is OFF xx = 01 is ON	
Set Auto-On	#aaB0cn1cn2x.xE-xx where cn1 is the Ion Gauge and cn2 is the TC.	>	

## XGS-600 Gauge Controller

**Table B-1 Serial Command Set (Continued)**

Description	Command	Response from XGS-600	Notes
Read Auto-On	#aaB1cn where cn is Ion Gauge.	>cnx.xExx where cn is the TC.	
<b>Ion Gauge Commands (HFIG and IMG gauges)</b>			
Assign Tube Type to Sensor	#aa16cnxx where xx = 11 for IMG100 (default) 13 for IMG300 51 for MBA100 52 for MBA200 63 for 563 64 for 564 71 for 571 72 for 572 80 for UHV24 (default) 81 for UHV24p	>	
Read Sensor Tube Type	#aa17cn	>xx where xx = 11 for IMG100 (default) 13 for IMG300 51 for MBA100 52 for MBA200 63 for 563 64 for 564 71 for 571 72 for 572 80 for UHV24 (default) 81 for UHV24p	
Set Emission OFF	#aa30cn	>	
Set Emission ON (Fil 1)	#aa31cn	>	Also used for single-filament gauges.
Read Emission status	#aa32cn	>xx where: xx = 00 is OFF xx = 01 is ON	
Set Emission ON (Fil2)	#aa33cn	>	



## XGS-600 Gauge Controller

**Table B-1 Serial Command Set (Continued)**

Description	Command	Response from XGS-600	Notes
Read Filament Lit	#aa34cn	>xx where: xx = 01 is Filament 1 xx = 02 is Filament 2	
Set Auto Fil Advance Off	#aa35	>	
Set Auto Fil Advance On	#aa36	>	
Read Auto Fil Advance State	#aa37	>xx where: xx = 00 is OFF xx = 01 is ON	
Set degas OFF	#aa40cn	>	
Set degas ON	#aa41cn	>	
Read degas status	#aa42cn	>xx where: xx = 00 is OFF xx = 01 is ON	
Read ion gauge gas correction	#aa50cn	>x.xxx	
Set ion gauge gas correction	#aa51cnx.xxx	>	
Read Emission current	#aa52cn	>x.xxx	Least significant two digits always zero.
Set Emission current	#aa53cnx.xxx	>	Least significant two digits will be ignored.
Read Sensitivity	#aa54cn	>xx.xx	Always reads in Torr. Least significant digit is always zero.

## XGS-600 Gauge Controller

**Table B-1 Serial Command Set (Continued)**

Description	Command	Response from XGS-600	Notes
Set Sensitivity	#aa55cnxx.xx	>	<p>This sensitivity value <u>must always be in Torr</u> due to xx.xx format restriction. Note however the value displayed on front panel is in Torr, mbar, or Pascal.</p> <p>Least significant digit will be ignored.</p> <p><b>Note: Will overwrite any factory setting.</b></p>
<b>Setpoint Commands</b>			
Read Setpoint States	#aa03	>00hh where hh is a hex value where each bit represents setpoints 1 - 8 and value 0=Off, 1=On	Setpoint numbers correspond to the numbers on the Setpoint screen.
Read assigned setpoints	#aa04cn	>00hh where hh is a hex value where each bit represents setpoints 1 - 8 and value 0=Not assigned, 1=Assigned	
Set Setpoint OFF/ON/Auto	#aa5Ehx where h is setpoint number 1-8 and x is state: 0 = OFF (manual override) 1 = ON (manual override) 3 = Auto (based on pressure) Example: #005E83 sets setpoint #8 to Auto.	>	

## XGS-600 Gauge Controller

**Table B-1 Serial Command Set (Continued)**

Description	Command	Response from XGS-600	Notes
Read Setpoint OFF/ON/Auto	#aa5Fh where h is setpoint number 1-8	>x where x is state: 0 = OFF (manual override) 1 = ON (manual override) 3 = Auto (based on pressure)	
Set Setpoint On pressure level	#aa6hcnx.xxxE-xx where h is setpoint number 1-8	>	
Set Setpoint ON Delay time	#aaChx.x where h is setpoint number 1-8 and x.x is delay in seconds. C is part of the hex command number. Example: #00C31.2 sets on delay to 1.2 seconds for setpoint # 3	>	Setpoint must first be assigned to a sensor using setpoint screen or command 6h.
Set Setpoint Off pressure level	#aa7hcnx.xxxE-xx where h is setpoint number 1 - 8	>	Setpoint ON level must be set before OFF level.
Set Setpoint Off Delay time	#aaDhx.x where h is setpoint number 1-8 and x.x is delay in seconds	>	Setpoint must be assigned to a sensor.
Read Setpoint On pressure level	#aa8h where h is setpoint number 1 - 8	>x.xxxE-xx	
Read Setpoint ON Delay time	#aaEh where h is setpoint number 1-8	>x.x where x.x is delay in seconds	
Read Setpoint Off pressure level	#aa9h where h is setpoint number 1 - 8	>x.xxxE-xx	

## XGS-600 Gauge Controller

**Table B-1 Serial Command Set (Continued)**

Description	Command	Response from XGS-600	Notes
Read Setpoint Off Delay time	#aaFh where h is setpoint number 1 - 8	>xx where x.x is delay in seconds	
<b>CNV Commands</b>			
Calibrate CNV	#aaA1cn where cn is a CNV	>	This command has the same function as CAL on the main screen, i.e. used for both atmosphere and vacuum calibrations.
Set Atmosphere Value	#aaA3x.xxxE+xx where pressure is local atmospheric value.	>	Same as System Setup screen Atmosphere Value.
Read CNV gas type	#aa4Ecn	>x where: x=0 for Nitrogen/Air x=1 for Argon	
Set CNV gas type	#aa4Fcnx where: x=0 for Nitrogen/Air x=1 for Argon	>	

**NOTE**

*All alpha characters must be upper case.*



Notes to owners of Multi-Gauge and SenTorr:

- ❑ Most commands used by Multi-Gauge and SenTorr are still found in this protocol.
- ❑ Commands which apply to Multi-Gauge/SenTorr but do not apply to the XGS are ignored by the XGS-600. There is no response and no error message.
- ❑ Any commands (ex. # 56-59) referring to a gauge or sensor type that is not supported by the XGS-600 result in ?FF error message.

## XGS-600 Gauge Controller

Backward-compatible sensor code can still be used in XGS-600 as with Multi-Gauge/SenTorr protocol:

Command Entry	Description	Notes
c	Sensor Code	=T for TC/CNV = I for ion gauge (HFIG or IMG) Case sensitive.
n	Sensor Count	Counting TCs or ion gauges from left to right from the front panel view. Example: #003013 turns on the third ion gauge.

### Using HyperTerminal

To see if communication has been established use a terminal emulator program like ProComm or Windows 3.xx Terminal or Hyperterminal.

- Use the recommended pre-made cinch cable type MDC-6 Pxx w/mini-Din connector.

### Windows HyperTerminal Set-Up Instructions

1. Click **Start**.
2. Select *Programs > Accessories > Communications > HyperTerminal*.
3. Double-click **Hypertrm.exe**. The *Connection Description* dialog box appears.
4. Enter a name and choose an icon for the connection, for example: XGS-600 RS-232.
5. Click **OK**. The *Connect To* dialog box appears.
6. Select a COM port from the *Connect Using*: the pull-down list. The *Com Properties/Port Setting* dialog box appears.
7. Configure the following settings:
  - Bits per second (baud rate) – **9600** or **19200**, whichever is set on XGS-600.
  - Data bits: – **8**
  - Parity: – **None**
  - Stop bits: – **1**
  - Flow Control: – **None**
8. Click **OK**.
9. Select **Properties** from the *File* menu. The *Properties* window appears.
10. Configure the following settings on the *Connect To* tab:
  - Connect using – Verify the COM port is correct.

## XGS-600 Gauge Controller

---

- Click **Configure** and verify the port settings are correct.
11. Ensure that the *Settings* tab is configured as follows:
- Terminal keys radio button selected.
  - Ctrl+H radio button selected.
  - Auto detect selected from the Emulation pull-down list.
  - ANSI entered in the Telnet terminal ID.
  - 500 set in the Background buffer lines field.
12. Click **ASCII Set-Up**. The *ASCII Set-Up* dialog box appears.
13. Ensure that the settings are as follows:
- Line delay – **0 milliseconds**
  - Character delay – **0 milliseconds**
  - ASCII Receiving – **Wrap lines that exceed terminal width**
- The cursor begins blinking.
14. Type some simple commands and see if there is a response:
- #0001
  - #0005
  - #000F

## Appendix C. BCD Serial Commands

The response time to serial command inquiries is approximately 10 msec and is defined as the time between receiving the last query character to transmission of the first response character. Serial queries occurring more frequently than 10 per second will compromise system responsiveness.

### C.1 Command Format

- ❑ The data format consists of a start bit (logic 0), 8 data bits, and a stop bit (logic 1). There is no parity bit.
- ❑ All commands are one byte commands that apply to the whole unit or are followed by one or more bytes to indicate the gauge the command is operating (Card Information Byte) and the desired pressure or parameter setting, if necessary.
- ❑ If an invalid command is received the XGS600 returns a one byte response of FFh.
- ❑ If a command is not completely received within approximately 5 seconds, the XGS600 ignores the command in process and expect a fully new command.
- ❑ In all of the following, the suffix *H* indicates hexadecimal notation.

#### C.1.1 Card Information Byte

This byte tells the controller which gauge channel to act on for reading pressure or changing status.

The card information byte consists of two nibbles. The first nibble is the board base address and is determined by the slot in which the board is installed. The second nibble is a 0 for HFIG and IMG boards and the Convectorr Gauge number (1,2,3...) for a Convection board. Since the XGS-600 board installation rules are different than Multigauge, the base address is not the same as the slot number. This allows maximum backwards compatibility with old applications. The mapping of slots and addresses is shown in Table C-1 (in the following instructions slot # refers to the XGS-600 physical slot):

**Table C-1 Card Information Byte Mapping**

XGS-600 Slot #	BCD base Address
1	2
2	3
3	4
4	5

## XGS-600 Gauge Controller

**Table C-1 Card Information Byte Mapping (Continued)**

XGS-600 Slot #	BCD base Address
5	1
6	6

This means that if a Multigauge had a UHV card installed in MG slot # 3, the HFIG card would have to be installed in XGS600 slot #2 for its BCD address to also be 3.

### C.1.2 Emulation of MG 4 Channel TC CARD

Since XGS-600 does not have a 4-channel TC card, backwards compatibility requires some way to emulate the 4-channel card. This is accomplished by installing two convection cards in physically adjacent slots. Doing this allows the second card to be addressed as the third and fourth channels of the first card and causes the Read Contents command to report the two cards as a 4-channel TC card installed in the lower numbered slot.

Example1: Convection cards are installed in slot #'s 5 and 6.

- Read Contents command reports *40h* for slot #5 (BCD addr 1).
- The card installed in slot 5 is addressed as BCD addrs 11 + 12. The card in slot 6 is addressed as BCD addrs 13 and 14.

Example 2: Convection cards are installed in slots 5 and 1.

- The Read Contents command reports the cards as *48H* at BCD addresses 1 and 2.
- The card installed in slot #5 is addressed as 11 + 12. The card in slot #1 is addressed as 21 and 22. This maintains compatibility with MG using two convector cards.

### C.1.3 Pressure Information

Pressure information is transmitted in the format of *x.xxxExx* and requires three bytes. The first two are the mantissa and the third is the exponent in two's complement notation.

For example:

```
7.600 E+2 --- {76h} {00h} {02h}
2.145E-7 --- {21h} {45h} {F9h}
OFF      ---- {00h} {00h} {00h}
```

Error codes are transmitted in MG/Sentorr format.

For example:

```
NO FIL1 is reported as E05 ---- {0Eh} {00h} {05h}
```



## XGS-600 Gauge Controller

---

P>MAX is reported as E09 ---- {0Eh} {00h} {09h}

Parameter information consists of two bytes, where Sensitivity is xx.xx and emission current and gas correction are x.xxx.

For example:

Sensitivity = 20.00 --- {20h} {00h}

emission current = 3.500ma - {35h} {00h}

### C.1.4 Reading All Pressure Channels

You can read all installed gauge channels with a single query command. The number of returned bytes is three times the number of installed gauges. The gauges are read in the order of the BCD base address. No separators are sent between bytes.

### C.1.5 Read MultiGauge Contents Command

To maintain compatibility with Multigauge, which only had 5 slots, this command outputs the ID of cards that are installed in addresses 1-5 only, even if a card is installed in BCD address 6.

The Multigauge's Porting capability is not supported by the XGS600

## C.2 Command List

Table C-1 lists all of the Multigauge BCD commands supported by the XGS600. The XGS600 does not support all old commands.

**Table C-2 BCD Command List**

Command	Byte # and Syntax	Byte # - Response
Read Card Contents (1 byte)  Response (5 bytes)	Byte 1- {01h} where: 10h = HFIG card set for UHV24 or UHV24p 20h = HFIG card set to 564, MBA100, MBA200 30h = HFIG card set to 572,571,563 3Ah= IMG card 40h = emulated 4ch TC card 48h = Convection card FFh = empty slot	Byte 1 - {card #1-ID}  Byte 2 - {card #1-ID}  Byte 3 - {card #1-ID}  Byte 4 - {card #1-ID}  Byte 5 - {card #1-ID}
Read Pressure (2 bytes)  Response (3 bytes)	Byte 1- {02h} Byte 2- {card info byte} while ---- appears, the response is 3 bytes of {00h}	Byte 1 - {mantissa digits 1,2}  Byte 2 - {mantissa digits 3,4}  Byte 3 - {exponent}
Read SW Revision (1 byte)  Response (2 bytes)	Byte 1- {05h}  where the revision is Px.y	Byte 1 - {0xh}  Byte 2- {0yh}
Reset to Default (1 byte)	Byte 1- {06h}	
Read Pressure Units (1byte)  Response (1 byte)	Byte 1- {13h}  where: 00h = Torr 01h = mBar 02h = Pa	Byte 1 - {xxh}

## XGS-600 Gauge Controller

**Table C-2 BCD Command List (Continued)**

Command	Byte # and Syntax	Byte # - Response
Emission OFF (2 byte)	Byte 1- {30h} Byte 2- {card info byte}	
Emission ON (2 bytes)	Byte 1- {31h} Byte 2- {card info byte}	
Emission ON Fil2 (2 bytes)	Byte 1- {33h} Byte 2- {card info byte}	
Read Emission Status (2 bytes)	Byte 1- {32h} Byte 2- {card info byte}	Byte 1 - {xxh}
Response (1 byte)	where 00h = OFF 01h = ON 02h = ON Fil2	
Degas OFF (2 bytes)	Byte 1- {40h} Byte 2- {card info byte}	
Degas ON (2 bytes)	Byte 1- {41h} Byte 2- {card info byte}	
Read Degas Status (2 bytes)	Byte 1- {42h} Byte 2- {card info byte}	Byte 1 - {xxh}
Response (1 byte)	where 00h = OFF 01h = ON	
Read Emission Curr (2 bytes)	Byte 1- {52h} Byte 2- {card info byte}	Byte 1 - mantissa digits 1,2}
Response (2 bytes)		Byte 2- {mantissa digits 3,4}
Set Emission Curr (4 bytes)	Byte 1- {53h} Byte 2- {card info byte} Byte 3- {mantissa digits 1,2} Byte 4- {mantissa digits 3,4}	

## XGS-600 Gauge Controller

**Table C-2 BCD Command List (Continued)**

Command	Byte # and Syntax	Byte # - Response
Read Sensitivity (2 bytes)  Response (2 bytes)	Byte 1 - {54h} Byte 2 - {card info byte}	Byte 1- {mantissa digits 1,2}  Byte 2- {mantissa digits 3,4}
Set Sensitivity (4 bytes)	Byte 1- {55h} Byte 2- {card info byte} Byte 3- {mantissa digits 1,2} Byte 4 - {mantissa digits 3,4}	
Set TC/Conv to ATM (2 bytes)	Byte 1- {A1h} Byte 2 - {card info byte}	
Set TC/Conv to VAC (2 bytes)	Byte 1 - {A2h} Byte 2 - {card info byte}	
Read Pressure All (1 byte)  Response (3 bytes times the number of gauges)	Byte 1 - {0Fh}	Byte 1- {mantissa digits 1,2} Byte 2- {mantissa digits 3,4} Byte 3- {exponent} ..{ } { } { } Runs from the lowest # address gauge to the highest# addr gauge

## Appendix D. Gas Correction Factor Table

Table D-2 on page D-2 lists relative gauge gas correction factors for various gases. The table is reproduced for convenience only.

**WARNING**



*The XGS-6000 used with any ion or convection gauge is NOT considered intrinsically safe, and should not be used with potentially flammable or explosive gas mixtures.*

The values are derived by empirical methods substantiated by measurements reported in literature. This table was compiled and published by Robert L. Summers of Lewis Research Center, NASA Technical Note TND-5285, National Aeronautics and Space Administration, Washington, DC, June 1969.

To automatically convert readings of the XGS-600 Controller, normally calibrated for nitrogen, to read pressures of the other gasses:

1. Use *Sensor Setup* to access the *GAS CORRECTION* function.
2. Enter the correction constant from the table.

The XGS600 multiplies the initial pressure reading by the gas correction constant and displays the correct adjusted value. The default for Gas Correction is 1.

The correction for different gas species is purely arithmetic. The sensitivity of the tube is affected by different gases which, in turn, are responsible for the tube output being manipulated by the pressure equation. There is some loss in resolution of the instrument when gas correction constants are used. The loss in resolution becomes more apparent as the correction constants approach 0.5 from either direction.

When the correction constants are 0.1 or 10, the tube output is 1/10 or 10 times normal. This causes the instrument to lose the high vacuum decade or the near atmosphere decade, respectively.

## XGS-600 Gauge Controller

---

**Table D-1 Gas Correction Factor Table**

<b>Gas Type</b>	<b>Gas Correction Factor</b>
Air/Nitrogen	1.00
Acetone	0.28
Argon	0.77
Carbon Dioxide	0.71
Carbon Monoxide	0.95
Chlorine	1.47
Deuterium	2.86
Ethanol	0.28
Ethylene	0.43
Helium	5.56
Hydrogen	2.17
Krypton	0.53
Methane	0.71
Methanol	0.56
Neon	0.30
Nitrous Oxide	0.67
Oxygen	1.00
Water	0.91
Xenon	0.34



## IMPORTANT Instructions for returning products

Dear Customer,

Please follow these instructions whenever one of our products needs to be returned:

1. Complete the *Request for Return* form on our website ([www.varianinc.com](http://www.varianinc.com)) and send it to Varian (see below), taking particular care to identify all products that have pumped or been exposed to any toxic or hazardous materials.
2. After evaluating the information, Varian will provide you with a Return Authorization (RA) number via email or fax, as requested.

**Note:** Depending on the type of return, a Purchase Order may be required at the time the Request for Return is submitted. We will quote any necessary services (evaluation, repair, special cleaning, e.g.).

3. **Important steps for the shipment of returning product:**
  - Remove all accessories from the core product (e.g. inlet screens, vent valves).
  - Prior to shipment, drain any oils or other liquids, purge or flush all gasses, and wipe off any excess residue.
  - If ordering an Advance Exchange product, **use the packaging from the Advance Exchange to return the defective product.**
  - Seal the product in a plastic bag, and package the product carefully to avoid damage in transit. You are responsible for loss or damage in transit.
  - Varian, Inc. is not responsible for returning customer provided packaging or containers.
  - Clearly label package with the RA number.** Using the shipping label provided ensures the proper address and RA number are on the package. Packages shipped to Varian without an RA clearly written on the outside cannot be accepted and will be returned.
4. Return only products for which the RA was issued.
5. **Product being returned under an RA must be received within 15 business days.**
6. **Ship to the location specified on the printable label, which will be sent, along with the RA number, as soon as we have received all of the required information.** Customer is responsible for freight charges on returning product.
7. Return shipments must comply with all applicable **Shipping Regulations** (IATA, DOT, etc.) and carrier requirements.

Return the completed request for return form to your nearest location:

**North America:**

FAX: 1-781-860-9252  
Toll Free: 800-8VARIAN  
(800-882-7426)

[vtl.ra@varianinc.com](mailto:vtl.ra@varianinc.com)

**Europe:**

FAX: 00 39-011-9979125  
Fax Free: 00 800 345 345 00  
Toll Free: 00 800 234 234 00

[vtt.ra@varianinc.com](mailto:vtt.ra@varianinc.com)

**Pacific Rim:**

Please visit our website for individual office information.

<http://www.varianinc.com/vacuum>

## XGS-600 Gauge Controller

---

*This page intentionally left blank.*





## Sales and Service Offices

### Canada

#### Central coordination through: Varian, Inc.

121 Hartwell Avenue  
Lexington, MA 02421  
USA  
Tel.: +1 781 861 7200  
Toll-Free: +1 800 882 7426  
Fax: +1 781 860 5437

### China

#### Varian Technologies China, Ltd.

Room 1648  
Central Tower South Wing  
Beijing Junefield Plaza  
No. 10 XuanWuMenWai Street  
Beijing 100052  
P. R. China  
Tel.: +86 (10) 6310 8550  
Toll-Free: 800 820 6556  
Fax: +86 (10) 6310 0141

### France

#### Varian s.a.

7 avenue des Tropiques  
Z.A. de Courtaboeuf - B.P. 12  
91941 Les Ulis cedex  
France  
Tel.: +33 (0) 1 69 86 38 84  
Fax: +33 (0) 1 69 86 29 88

### Benelux

#### Varian Vacuum Technologies

Herculesweg 8  
4338 PL Middelburg  
The Netherlands  
Tel.: +31 118 671570  
Fax: +31 118 671569

### Germany & Austria

#### Varian Deutschland GmbH

Alsfelder Strasse 6  
Postfach 11 14 35  
64289 Darmstadt  
Germany  
Tel.: +49 (0) 6151 703 353  
Fax: +49 (0) 6151 703 302

### India

#### Varian India Pvt. Ltd.

205-A, "A" wing of Galleria  
2nd floor, Hiranandani Gardens  
Powai, Mumbai-400 076  
India  
Tel.: +91 22 2570 8595/8597  
Fax: +91 22 2570 8599  
Mobile: +91 98 679 55969

### Italy

#### Varian, Inc.

via F.lli Varian 54  
10040 Leini, (Torino)  
Italy  
Tel.: +39 011 997 9111  
Toll-Free: 00 800 234 234 00  
Fax: +39 011 997 9350

### Japan

#### Varian Technologies Japan, Ltd.

8th Floor  
Sumitomo Shibaura Building  
4-16-36 Shibaura Minato-ku  
Tokyo 108  
Japan  
Tel.: +81 3 5232 1253  
Toll-Free: 0120 655 040  
Fax: +81 3 5232 1710

### Korea

#### Varian Technologies Korea, Ltd.

Shinsa 2nd Bldg. 2F  
966-5 Daechi-dong  
Kangnam-gu, Seoul  
Korea 135-280  
Tel.: +82 2 3452 2452  
Toll-Free: 080 222 2452  
Fax: +82 2 3452 2451

### Mexico

#### Varian, S. de R.L. de C.V.

Concepcion Beistegui No 109  
Col Del Valle  
C.P. 03100  
Mexico, D.F.  
Tel.: +52 5 523 9465  
Fax: +52 5 523 9472

### Taiwan

#### Varian Technologies Asia, Ltd.

14F-6, No. 77, Hsin Tai Wu Road, Sec. 1  
Hsi chih, Taipei Hsien  
Taiwan, R.O.C.  
Tel.: +886 2 2698 9555  
Toll Free: 0800 051 342  
Fax: +886 2 2698 96782

### UK & Ireland

#### Varian Ltd.

6 Mead Road  
Oxford Industrial Park  
Yarnton, Oxford OX5 1QU  
UK  
Tel.: +44 (0) 1865 291570  
Fax: +44 (0) 1865 291571

### United States

#### Varian, Inc

121 Hartwell Avenue  
Lexington, MA 02421  
USA  
Tel.: +1 781 861 7200  
Toll-Free: +1 800 882 7426  
Fax: +1 781 860 5437

### Other Countries

#### Varian Vacuum Technologies

via F.lli Varian 54  
10040 Leini, (Torino)  
Italy  
Tel: (39) 011 997 9 111  
Fax: (39) 011 997 9 350

### Customer Support and Service:

#### North America

Tel: 1 (800) 882-7426 (toll-free)  
vtl.technical.support@varianinc.com

#### Europe

Tel: 00 (800) 234 234 00 (toll-free)  
vtl.technical.support@varianinc.com

#### Japan

Tel: (81) 3 5232 1253 (dedicated line)  
vtj.technical.support@varianinc.com

#### Korea

Tel (82) 2 3452 2452 (dedicated line)  
vtk.technical.support@varianinc.com

#### Taiwan

Tel: 0 (800) 051 342 (toll-free)  
vtw.technical.support@varianinc.com

### Worldwide Web Site, Catalog and On-line Orders:

www.varianinc.com

Representatives in most countries

