

Operating Instructions
Incl. Declaration of Conformity

Compact Pirani Gauge

TPR 280
TPR 281

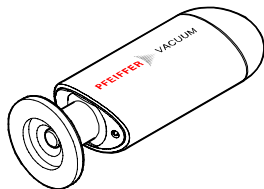

BG 805 178 BE / D (2006-02)

Product Identification

In all communications with Pfeiffer Vacuum, please specify the information on the product nameplate. For convenient reference copy that information into the space provided below.

Pfeiffer Vacuum, D-35614 Asslar

Typ: _____
No: _____
F-No: _____
____ V ____ W

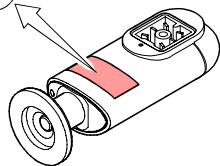

Validity

This document applies to products with the following part numbers:

TPR 280 (W filament)	TPR 281 (Ni filament)	
PTR26950	PTR21950	(DN 16 ISO-KF)
PTR26951	PTR21951	(DN 16 CF-R)
PTR26960	PTR21960	(DN 16 ISO-KF long tube)
PTR26961	PTR21961	(DN 16 CF-R long tube)

The part number (No) can be taken from the product nameplate.

If not indicated otherwise in the legends, the illustrations in this document correspond to gauges with DN 16 ISO-KF vacuum connections. They apply other vacuum connections by analogy.

We reserve the right to make technical changes without prior notice.

All dimensions in mm.

Intended Use

The Compact Pirani Gauges TPR 280 and TPR 281 have been designed for vacuum measurement of gases in the pressure range of 5×10^{-4} ... 1000 mbar.

The gauges must not be used for measuring flammable or combustible gases which react in air.

They can be operated in connection with a Pfeiffer Vacuum controller for Compact Gauges or with another evaluation unit.

Safety

Symbols Used

 **DANGER**

Information on preventing any kind of physical injury.

 **WARNING**

Information on preventing extensive equipment and environmental damage.

 **Caution**

Information on correct handling or use. Disregard can lead to malfunctions or minor equipment damage.

Personnel Qualifications

 **Skilled personnel**

All work described in this document may only be carried out by persons who have suitable technical training and the necessary experience or who have been instructed by the end-user of the product.

General Safety Instructions

- Adhere to the applicable regulations and take the necessary precautions for the process media used. Consider possible reactions between the materials and the process media. Consider possible reactions of the process media due to the heat generated by the product (e.g. explosions).
- Adhere to the applicable regulations and take the necessary precautions for all work you are going to do and consider the safety instructions in this document.
- Before beginning to work, find out whether any vacuum components are contaminated. Adhere to the relevant regulations and take the necessary precautions when handling contaminated parts.

Communicate the safety instructions to all other users.

Liability and Warranty

Pfeiffer Vacuum assumes no liability and the warranty becomes null and void if the end-user or third parties

- disregard the information in this document
- use the product in a non-conforming manner
- make any kind of interventions (modifications, alterations etc.) on the product
- use the product with accessories not listed in the product documentation.

The end-user assumes the responsibility in conjunction with the process media used.

Gauge failures due to contamination, as well as expendable parts (filament), are not covered by the warranty.

Technical Data

Measurement principle	thermal conductance according to Pirani	
Measurement range (air, O ₂ , CO, N ₂)	5×10 ⁻⁴ ... 1000 mbar	
Accuracy (N ₂)	1×10 ⁻³ ... 100 mbar	±15% of reading
	5×10 ⁻⁴ ... 1×10 ⁻³ mbar	±50% of reading
	100 ... 1000 mbar	±50% of reading
Resolution	1% of reading	
Repeatability with air	1×10 ⁻³ ... 100 mbar	2% of reading



Output signal (measurement signal)		
Voltage range	VDC	0 ... +9.0
Measurement range	VDC	+2.2 ... +8.5
Voltage vs. pressure	logarithmic 1.0 V/decade	
Error signal	V	0 ... +0.5 (filament rupture)

Output impedance	Ω	2×4.7
Minimum loaded impedance	kΩ	10, short-circuit proof
Response time	ms	80

Gauge identification	3.0 kΩ, referenced to supply common (voltage at pin 1 ≤5 V)	
----------------------	-------------------------------------------------------------	--

Adjustment	one tactile switch for ATM and HV adjustment	
------------	----------------------------------------------	--

Supply

		
	The gauge may only be connected to power supplies, instruments or control devices that conform to the requirements of a grounded extra-low voltage (SELV-E according to EN 61010). The connection to the gauge has to be fused ¹⁾ .	

Supply voltage		
At gauge	VDC	+14 ... +30
Ripple	V _{pp}	≤1
Current consumption	mA	<500 (max. starting current)
Power consumption	W	≤1
Fuse required ¹⁾	AT	1 (slow)

Electrical connection	Hirschmann appliance connector, male, type GO 6, 6 poles	
Sensor cable	5 poles plus shielding	
Cable length	≤150 m (5×0.25 mm ²)	≤200 m (5×0.34 mm ²)

Grounding concept	→ "Electrical Connection"	
Vacuum connection to signal common	connected via 1 MΩ (voltage difference <15 V)	
Supply common to signal common	conducted separately, for differential measurement	

Materials exposed to vacuum	DIN 1.4301, DIN 1.4305, DIN 1.4435, glass, Ni, NiFe	
-----------------------------	-----------------------------------------------------	--

Filament		
PTR26xxx	W	
PTR21xxx	Ni	

Internal volume		
PTR26950, PTR21950	cm ³	≈1.5
PTR26951, PTR21951	cm ³	≈1.5
PTR26960, PTR21960	cm ³	≈10
PTR26961, PTR21961	cm ³	≈10
Admissible pressure	bar	10, limited to inert gases (abs.)

¹⁾ Pfeiffer Vacuum controllers fulfill these requirements.

Admissible temperatures		
Operation	°C	+5 ... +60
Vacuum connection		
DN 16 ISO-KF	°C	80 ²⁾ in horizontal mounting orientation
DN 16 CF-R	°C	80 ²⁾ in horizontal mounting orientation
Filament	°C	110
Storage	°C	-20 ... +65

Relative humidity	%	≤80 at temperatures up to ≤+31 °C, decreasing to 50 at +40 °C
-------------------	---	---------------------------------------------------------------

Use indoors only, altitude up to 2000 m NN

Mounting orientation	any
Degree of protection	IP40

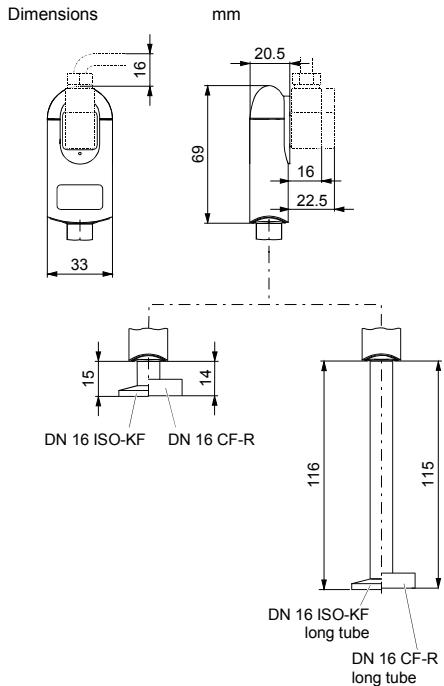

Weight	
PTR26950, PTR21950	g 80
PTR26951, PTR21951	g 100
PTR26960, PTR21960	g 130
PTR26961, PTR21961	g 140

Measurement Signal vs. Pressure

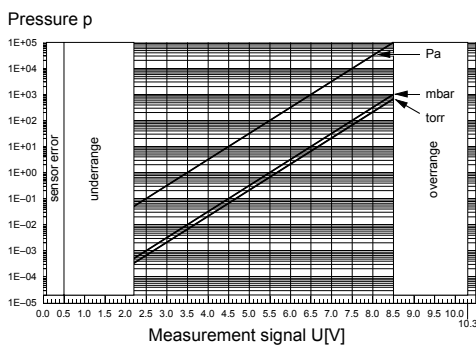

$$p = 10^{(U-c)} \Leftrightarrow U = c + \log_{10} p$$

valid in the range 5×10^{-4} mbar $< p < 1000$ mbar
 3.75×10^{-4} Torr $< p < 750$ Torr
 5×10^{-2} Pa $< p < 1 \times 10^5$ Pa

U	p	c	U	p	c
[V]	[mbar]	5.5	[V]	[micron]	2.625
[V]	[µbar]	2.5	[V]	[Pa]	3.5
[V]	[Torr]	5.625	[V]	[kPa]	6.5
[V]	[mTorr]	2.625			

where p pressure
 U measurement signal
 c constant (depending on pressure unit)

Gas Type Dependence

Pressure reading (gauge adjusted for air)
 p (mbar)

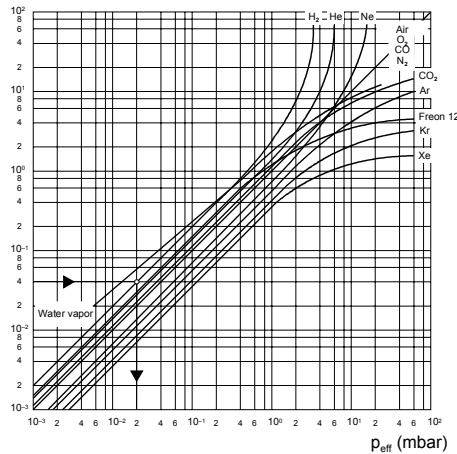

Calibration factors for the pressure range below 1 mbar

$$p_{\text{eff}} = C \times \text{pressure reading}$$

Gas type	Calibration factor C	Gas type	Calibration factor C
He	0.8	H ₂	0.5
Ne	1.4	air, O ₂ , CO, N ₂	1.0
Ar	1.7	CO ₂	0.9
Kr	2.4	water vapor	0.5
Xe	3.0	freon 12	0.7

Installation

Vacuum Connection

STOP DANGER

Caution: overpressure in the vacuum system >1 bar

Injury caused by released parts and harm caused by escaping process gases can result if clamps are opened while the vacuum system is pressurized.

Do not open any clamps while the vacuum system is pressurized. Use the type clamps which are suited to overpressure.

STOP DANGER

Caution: overpressure in the vacuum system >2.5 bar

KF connections with elastomer seals (e.g. O-rings) cannot withstand such pressures. Process media can thus leak and possibly damage your health.

Use O-rings provided with an outer centering ring.

STOP DANGER

Caution: protective ground

Incorrectly grounded products can be extremely hazardous in the event of a fault.

The gauge must be electrically connected to the grounded vacuum chamber. This connection must conform to the requirements of a protective connection according to EN 61010:

- CF connections fulfill this requirement.
- For gauges with a KF connection, use a conductive metallic clamping ring

Caution

Caution: vacuum component

Dirt and damages impair the function of the vacuum component.

When handling vacuum components, take appropriate measures to ensure cleanliness and prevent damages.

Caution

Caution: dirt sensitive area

Touching the product or parts thereof with bare hands increases the desorption rate.

Always wear clean, lint-free gloves and use clean tools when working in this area.

The gauge may be mounted in any orientation. To keep condensates and particles from getting into the measuring chamber preferably choose a horizontal to upright position and possibly use a seal with a centering ring and filter. If adjustment should be possible after the gauge has been installed, be sure to install it so that the tactile switch can be accessed with a pin (→ "Adjusting the Gauge").

Remove the protective lid and install the product to the vacuum system.

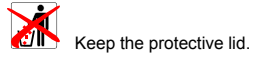
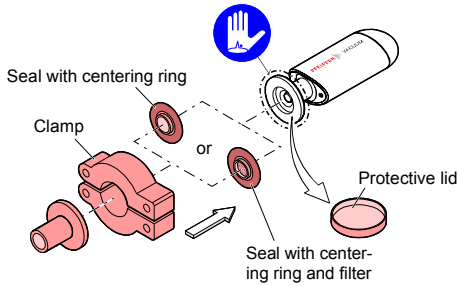

Electrical Connection

Make sure the vacuum connection is properly made (→ "Vacuum Connection").

- If no sensor cable is available, make one according to the following diagram.

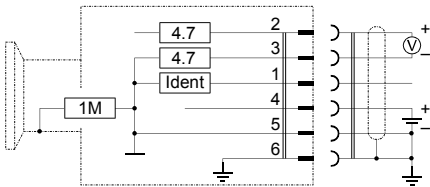
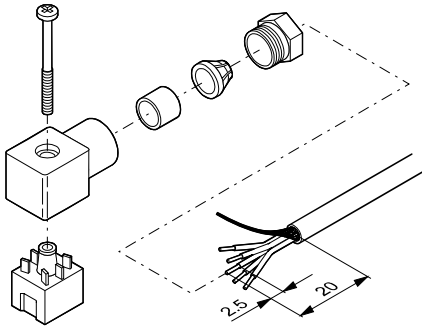

Electrical connection

Pin 1 Identification
 Pin 2 Signal output (measurement signal)
 Pin 3 Signal common
 Pin 4 Supply
 Pin 5 Supply common
 Pin 6 Screening

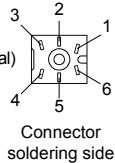

- Connect the sensor cable to the gauge and secure the connector with the lock screw.

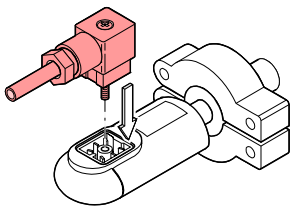

- Connect the sensor cable to the controller.

Operation

When the supply voltage is applied, the measurement signal is available between pins 2 and 3 (relationship between measurement signal and pressure → "Technical Data").

Allow a stabilization period of at least 10 minutes. It is advisable to operate the gauge continuously, irrespective of the pressure.

Gas Type Dependence

The measurement value is gas dependent. The pressure reading applies to dry air, O₂, CO and N₂. For other gases, it has to be corrected (→ "Technical Data").

If the gauge is operated with a Pfeiffer Vacuum controller for Compact Gauges, a calibration factor for correction of the actual reading can be applied (→ of the corresponding controller).

Adjusting the Gauge

The gauge is factory calibrated. Due to long time operation or contamination, a zero drift could occur. Periodically check the zero and adjust it if necessary.

For adjusting the zero, operate the gauge under the same ambient conditions and in the same mounting orientation as normally.

The gauge is adjusted to default values. However, it can also be adjusted to other pressure values, if the exact pressure value is known (reference measurement).

- If you are using a seal with centering ring and filter, check that they are clean and replace them if necessary (→ "Deinstallation").
- Activate the gauge and operate it at atmospheric pressure for at least 10 minutes.
- Press the button with a pin (max. $\varnothing 1.1$ mm) and the ATM adjustment is carried out: The gauge is adjusted to 1000 mbar (8.50 VDC) by default. By pressing the button >5 s the pressure value is increased towards 1200 mbar (or, by pressing it again, decreased towards 500 mbar) until the button is released or the limit is reached.

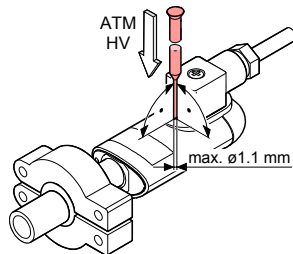

- Evacuate to $p \ll 10^{-4}$ mbar (recommended) or to a pressure in the range of $10^{-4} \dots 10^{-2}$ mbar and wait at least 2 minutes.
- Press the button with a pin and the HV adjustment is carried out: The gauge is adjusted to 1×10^{-4} mbar (1.50 VDC) by default. By pressing the button >5 s the pressure value is increased toward 1×10^{-2} mbar until the button is released or the limit is reached.

Deinstallation

STOP DANGER

Caution: contaminated parts
 Contaminated parts can be detrimental to health and environment.
 Before beginning to work, find out whether any parts are contaminated. Adhere to the relevant regulations and take the necessary precautions when handling contaminated parts.

Caution

Caution: vacuum component
 Dirt and damages impair the function of the vacuum component.
 When handling vacuum components, take appropriate measures to ensure cleanliness and prevent damages.

Caution

Caution: dirt sensitive area
 Touching the product or parts thereof with bare hands increases the desorption rate.
 Always wear clean, lint-free gloves and use clean tools when working in this area.

- Vent the vacuum system.
- Turn the gauge off.
- Unfasten the lock screw and unplug the sensor cable.

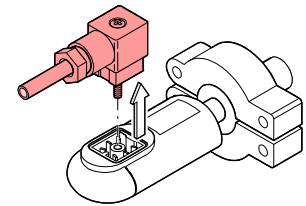

- Remove the gauge from the vacuum system.

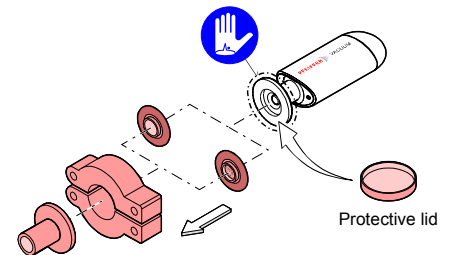

Maintenance, Repair

In case of severe contamination or a malfunction, the sensor can be replaced.

Gauge failures due to contamination, as well as expendable parts (filament), are not covered by the warranty.

Pfeiffer Vacuum assumes no liability and the warranty becomes null and void if any repair work is carried out by the end-user or third parties.

Spare Parts

When ordering spare parts, always indicate:

- all information on the product nameplate
- description and ordering number according to the spare parts list

W sensor for gauge	Ordering number	Ni sensor for gauge	Ordering number
PTR26950	PT120133-T	PTR21950	PT120141-T
PTR26951	PT120135-T	PTR21951	PT120143-T
PTR26960	PT120134-T	PTR21960	PT120142-T
PTR26961	PT120136-T	PTR21961	PT120144-T

Returning the Product

WARNING



Caution: forwarding contaminated products
Contaminated products (e.g. radioactive, toxic, caustic or microbiological hazard) can be detrimental to health and environment.
Products returned to Pfeiffer Vacuum should preferably be free of harmful substances. Adhere to the forwarding regulations of all involved countries and forwarding companies and enclose a duly completed declaration of contamination.

Products that are not clearly declared as "free of harmful substances" are decontaminated at the expense of the customer.
Products not accompanied by a duly completed declaration of contamination are returned to the sender at his own expense.

Disposal

DANGER



Caution: contaminated parts
Contaminated parts can be detrimental to health and environment.
Before beginning to work, find out whether any parts are contaminated. Adhere to the relevant regulations and take the necessary precautions when handling contaminated parts.

WARNING



Caution: substances detrimental to the environment
Products or parts thereof (mechanical and electric components, operating fluids etc.) can be detrimental to the environment.
Dispose of such substances in accordance with the relevant local regulations.

Separating the components

After disassembling the product, separate its components according to the following criteria:

- Contaminated components
Contaminated components (radioactive, toxic, caustic, or biological hazard etc.) must be decontaminated in accordance with the relevant national regulations, separated according to their materials, and disposed of.
- Other components
Such components must be separated according to their materials and recycled.

Declaration of Contamination

The service, repair, and/or disposal of vacuum equipment and components will only be carried out if a correctly completed declaration has been submitted. Non-completion will result in delay.
This declaration may only be completed (in block letters) and signed by authorized and qualified staff.

- Description of product**
Type _____
Part number _____
Serial number _____
- Reason for return**

- Operating fluid(s) used**
(Must be drained before shipping.)

- Used in copper process**
no yes → Seal product in plastic bag and mark it with a corresponding label.
- Process related contamination of product:**

toxic	no <input type="checkbox"/> 1)	yes <input type="checkbox"/>	
corrosive	no <input type="checkbox"/> 1)	yes <input type="checkbox"/>	
biological hazard	no <input type="checkbox"/>	yes <input type="checkbox"/> 2)	
explosive	no <input type="checkbox"/>	yes <input type="checkbox"/> 2)	
radioactive	no <input type="checkbox"/>	yes <input type="checkbox"/> 2)	
other harmful substances	no <input type="checkbox"/> 1)	yes <input type="checkbox"/>	

1) or not containing any amount of hazardous residues that exceed the permissible exposure limits
2) Products thus contaminated will not be accepted without written evidence of decontamination.

The product is free of any substances which are damaging to health. yes
- Harmful substances, gases and/or by-products**
Please list all substances, gases, and by-products which the product may have come into contact with:

Trade/product name manufacturer	Chemical name (or symbol)

Precautions associated with substance	Action if human contact
- Legally binding declaration:**
We hereby declare that the information on this form is complete and accurate and that we will assume any further costs that may arise. The contaminated product will be dispatched in accordance with the applicable regulations.
 Organization/company _____
 Address _____
 Post code, place _____
 Phone _____ Fax _____
 Email _____
 Name _____
 Company stamp _____

 Date and legally binding signature _____

Declaration of Conformity



We, Pfeiffer Vacuum, hereby declare that the equipment mentioned below complies with the provisions of the Directive relating to electrical equipment designed for use within certain voltage limits 73/23/EEC and the Directive relating to electromagnetic compatibility 89/336/EEC.

Compact Pirani Gauge

TPR 280
TPR 281

Part numbers

PTR26950 PTR21950
PTR26951 PTR21951
PTR26960 PTR21960
PTR26961 PTR21961

Standards

Harmonized and international/national standards and specifications:

- EN 61000-6-2 (Electromagnetic compatibility: generic immunity standard)
- EN 61000-6-3 (Electromagnetic compatibility: generic emission standard)
- EN 61010 (Safety requirements for electrical equipment for measurement, control and laboratory use)

Signature

Pfeiffer Vacuum GmbH, Asslar
19 December 2005

Wolfgang Dondorf
Managing director

This form can be downloaded from our website.

Copies: Original for addressee
1 copy for accompanying documents
1 copy for file of sender

PFEIFFER VACUUM

Berliner Strasse 43
D-35614 Asslar
Deutschland
Tel +49 (0) 6441 802-0
Fax +49 (0) 6441 802-202
info@pfeiffer-vacuum.de
www.pfeiffer-vacuum.net