



DCU 002, 110, 180, 310, 400

Display and control unit

Operating Instructions

Table of contents

1	About this manual	3
	1.1 Validity	3
	1.2 Conventions	3
2	Safety	5
	2.1 Safety precautions	5
	2.2 Proper use	5
	2.3 Improper use	6
3	Product description	7
	3.1 Product identification	7
	3.2 Function	7
	3.3 General connection description	8
	3.4 Range of application	8
4	Connections diagram	9
5	Installation	10
	5.1 Assembly	10
	5.2 Connecting to the mains power supply	10
	5.3 Connections	11
6	Operation	12
	6.1 LC-Display	12
	6.2 Symbol description	13
	6.3 Button functions	13
	6.4 Switching on	14
	6.5 Operation	14
	6.6 Operation with DCU	15
	6.7 Pressure measurement via DCU	15
	6.8 Switching off	16
7	Malfunctions	17
	7.1 Operating mode display via LED	17
	7.2 Error codes	17
8	Service	18
9	Accessories	18
10	Technical data and dimensions	19
	10.1 Technical data and dimensions	19
	10.2 Dimensions	20
	Declaration of conformity	21

1 About this manual

1.1 Validity

This operating manual is for customers of Pfeiffer Vacuum. It describes the functioning of the designated product and provides the most important information for safe use of the unit. The description follows applicable EU guidelines. All information provided in this operating manual refer to the current state of the product's development. The documentation remains valid as long as the customer does not make any changes to the product.

Up-to-date operating instructions can also be downloaded from www.pfeiffer-vacuum.com.

1.2 Conventions

Safety instructions

The safety instructions in Pfeiffer Vacuum operating instructions are the result of risk evaluations and hazard analyses and are oriented on international certification standards as specified by UL, CSA, ANSI Z-535, SEMI S1, ISO 3864 and DIN 4844. In this document, the following hazard levels and information are considered:

DANGER
<p>Imminent danger Indicates an imminent hazardous situation that will result in death or serious injury.</p>
WARNING
<p>Possibly imminent danger Indicates an imminent hazardous situation that can result in death or serious injury.</p>
CAUTION
<p>Possibly imminent danger Indicates an imminent hazardous situation that can result in minor or moderate injury.</p>
NOTICE
<p>Command or note Command to perform an action or information about properties, the disregarding of which may result in damage to the product.</p>

Pictograph definitions



Prohibition of an action or activity in connection with a source of danger, the disregarding of which may result in serious accidents



Warning of a displayed source of danger in connection with operation of the unit or equipment

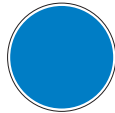

Command to perform an action or task associated with a source of danger, the disregarding of which may result in serious accidents



Important information about the product or this document

Instructions in the text

→ Work instruction: here you have to do something.

Abbreviations used

DCU: Display and control unit
TC: Electronic drive unit for turbopump
TPS: Mains pack
[P:000]: Parameter of the electronic drive unit with number

2 Safety

2.1 Safety precautions



Duty to inform

Each person involved in the installation or operation of the unit must read and observe the safety-related parts of these operating instructions.

→ The operator is obligated to make operating personnel aware of dangers originating from the unit or the entire system.



WARNING

Danger of unsafe electrical installation

Safe operation after installation is the responsibility of the operator.

- Do not independently modify or change the pump and electrical equipment.
- Make sure that the system is integrated in an emergency off safety circuit.
- Consult Pfeiffer Vacuum for special requirements.



WARNING

Danger of electric shock

In case of defect, the parts connected to the mains supply are under voltage.

→ Always keep the mains connection freely accessible so you can disconnect it at any time.

- Observe the safety and accident prevention regulations.
- Check regularly that all safety precautions are being complied with.
- Do not loosen any plug connection during operations.
- Keep leads and cables well away from hot surfaces (> 70 °C).
- Always ensure a safe connection to the protective earthing conductor (PE, protection class I).
- The unit has been accredited with protection class IP 20. Take necessary measures when installing into ambient conditions, which afford other protection classes.
- Before carrying out any work disconnect the unit and all associated installations safely from the mains.

2.2 Proper use



NOTICE

CE conformity

The manufacturer's declaration of conformity becomes invalid if the operator modifies the original product or installs additional components.

→ Following installation into a plant and before commissioning, the operator must check the entire system for compliance with the valid EU directives and reassess it accordingly.

- The DCU is a display and control unit and may only be used to control Pfeiffer Vacuum Turbopumps with electronic drive unit and associated peripheral devices.
- The DCU with integrated powerpack is also used to supply power to the turbopump.

2.3 Improper use

Improper use will cause all claims for liability and warranties to be forfeited. Improper use is defined as usage for purposes deviating from those mentioned above, especially:

- connection to pumps or units which are not suitable for this purpose according to their operating instructions
- connection to units which have exposed voltage-carrying parts
- connection to mains supplies, which do not confirm to the regulations IEC 61010 or IEC 60950
- operation of the devices in areas with ionizing radiation

3 Product description

3.1 Product identification

Product features

The DCU is a display and control unit for Pfeiffer Vacuum Turbopumps with integrated electronic drive unit. It enables control of all essential parameters for the electronic drive unit. It is also possible to connect a pressure gauge.

Characteristics	DCU 002	DCU 110	DCU 180	DCU 310	DCU 400
Mains supply	none	integrated	integrated	integrated	integrated
Power consumption	5 VA	130 VA	210 VA	340 VA	450 VA
Suitable for HiPace	all	10, 60, 80	300	300, 400, 700, 800	300, 400, 700, 800
Electronic drive unit	TC 110 TC 400 TM 700 TC 1200	TC 110	TC 110	TC 400 (24 V DC)	TC 400 (48 V DC) TM 700

To correctly identify the product when communicating with Pfeiffer Vacuum, always have the information from the rating plate available.

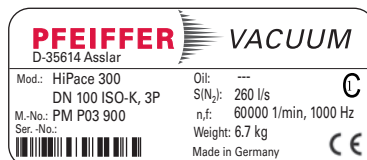

Fig. 1: Example for a rating plate

Scope of delivery

- Display and control unit DCU
- Interface cable M12 to M12, length 3 m
- Fixing materials
- Operating instructions

3.2 Function

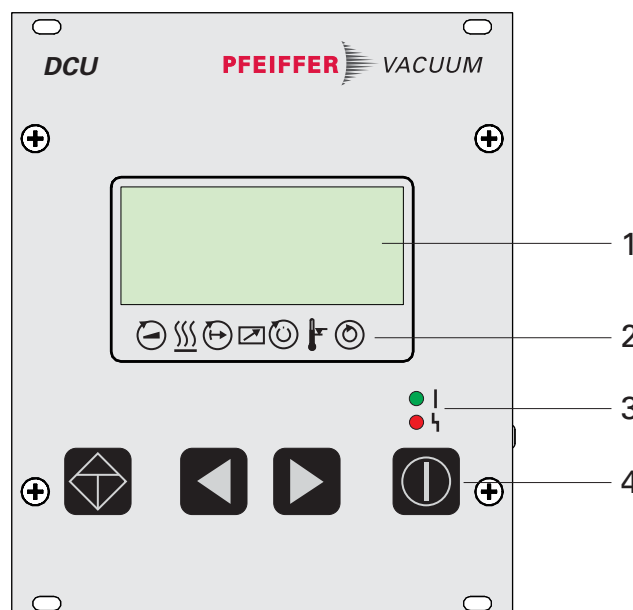

Fig. 2: Front cover DCU

- | | | | |
|---|-------------------------|---|-------------------------|
| 1 | LC display, illuminated | 3 | LED "Operating display" |
| 2 | Status symbols | 4 | Operating keys |

3.3 General connection description

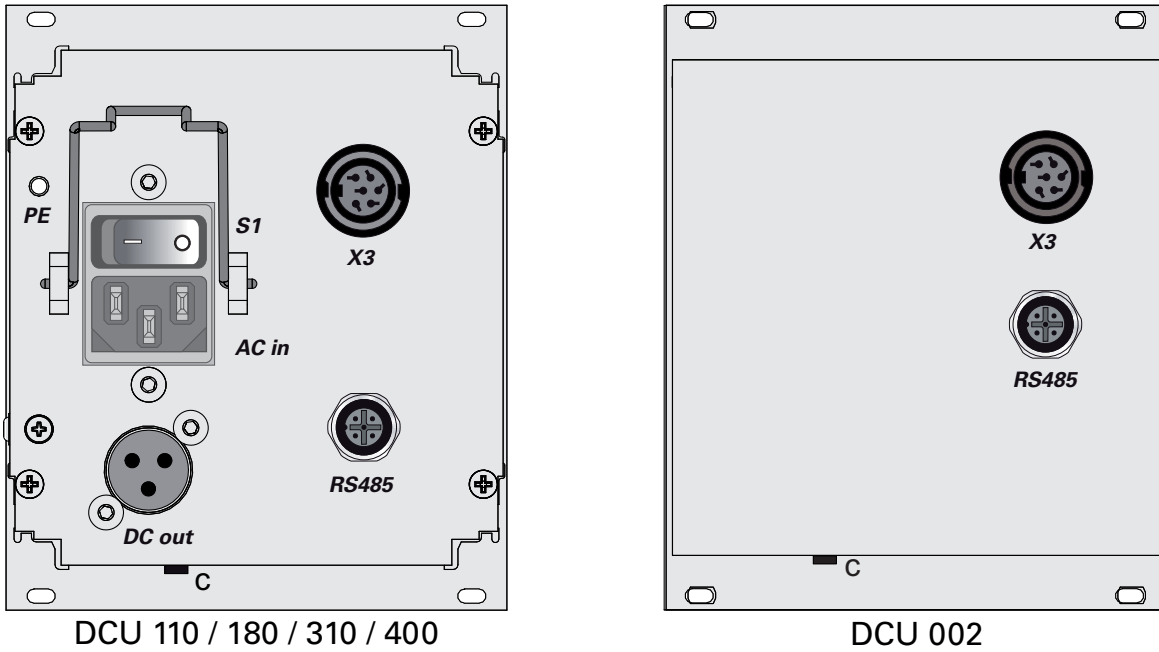

Fig. 3: Display and control unit DCU, rear view variants

- | | | | |
|--------|--------------------------|-------|----------------------------------|
| S1 | Mains switch | PE | Protective earth connection (M4) |
| AC in | Mains connection, input | X3 | Pressure gauge connection |
| DC out | Mains connection, output | RS485 | Serial interface |
| | | C | Contrast adjustment |

3.4 Range of application

Pfeiffer Vacuum display and control units DCU should be installed and operated under the following ambient conditions.

Installation location	weatherproof (internal space)
Permissible protection class	IP 20
Protection class	I
Temperature	+5 °C to +50 °C
Relative air humidity	max. 80%, at T ≤ 31°C, max. 50% at T ≤ 40°C
Air pressure:	75 kPa - 106 kPa

4 Connections diagram

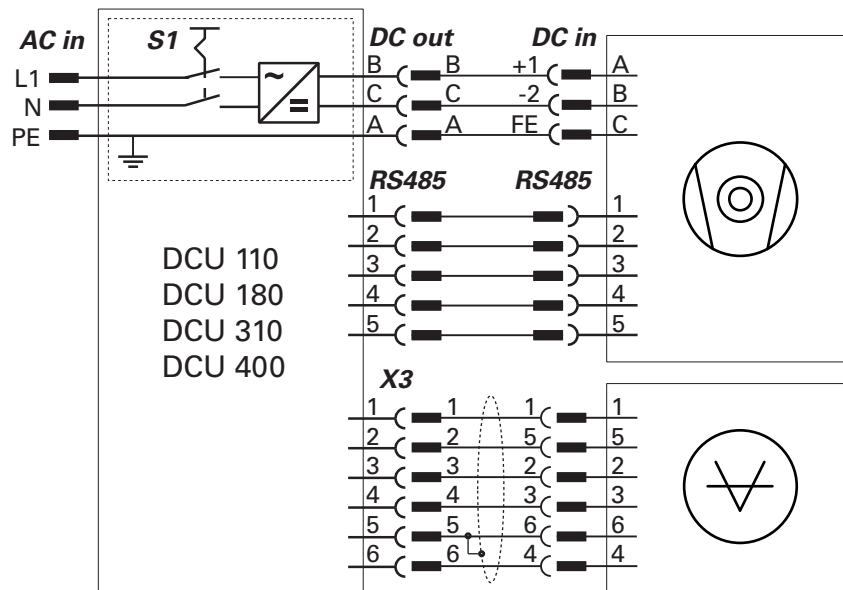

Fig. 4: Terminal diagram and layout for DCU, variants with integrated power pack

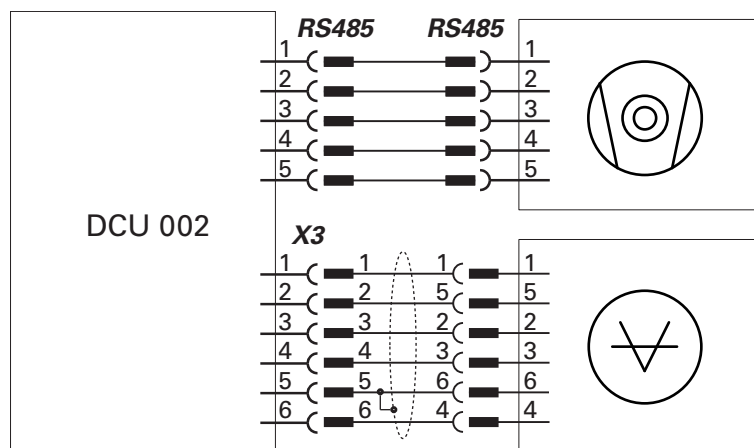



Fig. 5: Terminal diagram and layout for DCU 002

Connection to:	DCU 002	DCU 110/180/310/400
 Turbopump with electronic drive unit:	TC 110* TC 400 TM 700 TC 1200	TC 110* TC 400 TM 700
 Gauge type:	TPR 2xx PKR 2xx APR 250/260 CMR 3xx PCR 280	TPR 2xx PKR 2xx APR 250/260 CMR 3xx PCR 280



Connections on electronic drive unit TC 110

Different connection possibilities (not provided in the scope of supply) are dependent on the type of electronic drive unit TC 110.

- Connection via connecting cable or adapter
- Connection for electronic drive unit "TC 110 RS" direct to the RS485 interface (power supply separately via TCP or connecting cable)
- For more information visit <http://www.pfeiffer-vacuum.com>, Keyword "HiPace accessories"

5 Installation

5.1 Assembly



NOTICE

Ensure free convection

Incorrect installation can cause damage by over-heating or create a fire hazard.

- Maintain a minimum distance of 50 mm from cooling vents to adjacent components or boundaries.
- Install device perpendiculary.

Install in a rack as a 19" module

The DCU is fitted in a casing that is suitable for installing in 19"/3HE rack modules.

- Insert the DCU in the guiderails of a 19"/3HE rack and screw on the front panel securely with four fixing screws provided as part of the scope of supply.

5.2 Connecting to the mains power supply

This only applies to DCUs with integrated power packs. The DCU 002 receives the operating voltage via the "RS485" interface for the turbopump electronic drive unit.



WARNING

Danger of unsafe electrical installation

Safe operation after installation is the responsibility of the operator.

- Do not independently modify or change the pump and electrical equipment.
- Make sure that the system is integrated in an emergency off safety circuit.
- Consult Pfeiffer Vacuum for special requirements.



WARNING

Danger of electric shock

In case of defect, the parts connected to the mains supply are under voltage.

- Always keep the mains connection freely accessible so you can disconnect it at any time.
- Order the mains cable separately (see "accessories").
- Switch off switch S1 on the power pack (position "0").
- Plug mains cable into the mains connection "AC in".
- Lock the mains cable with the mounting bracket.
- Connect the mains cable to the mains.
- Always ensure a safe connection to the protective earthing conductor (PE, protection class I).

5.3 Connections

- Connect interface cable (supplied) on "RS485" to DCU and electronic drive unit.
- Make connection between "DC out" on DCU and "DC in" on electronic drive unit in accordance with the terminal diagram or with a connecting cable from the Pfeiffer Vacuum accessories.
- Connect pressure gauge if required to "X3" on the DCU.
- The RS485 serial interface is used exclusively to control the electronic drive unit on the vacuum pump. See the Operating Instructions for the respective electronic drive unit for the interface protocol specification.



Note the operating priority of the interfaces for the electronic drive unit!
 DIL switches in the connecting cable or bridges in the mating connector for the D-Sub connector for the electronic drive unit enable operation of the pump without control unit. This may cause priority conflicts with the RS485 interface.

- Disconnect the mating connector from the "remote" terminal prior to connecting a DCU to electronic drive units TC 400, TC 1200 or TM 700.
- Switch off the supreme operating control (DIL switch S1/S2 = OFF) prior to connecting a DCU to the electronic drive unit TC 110.

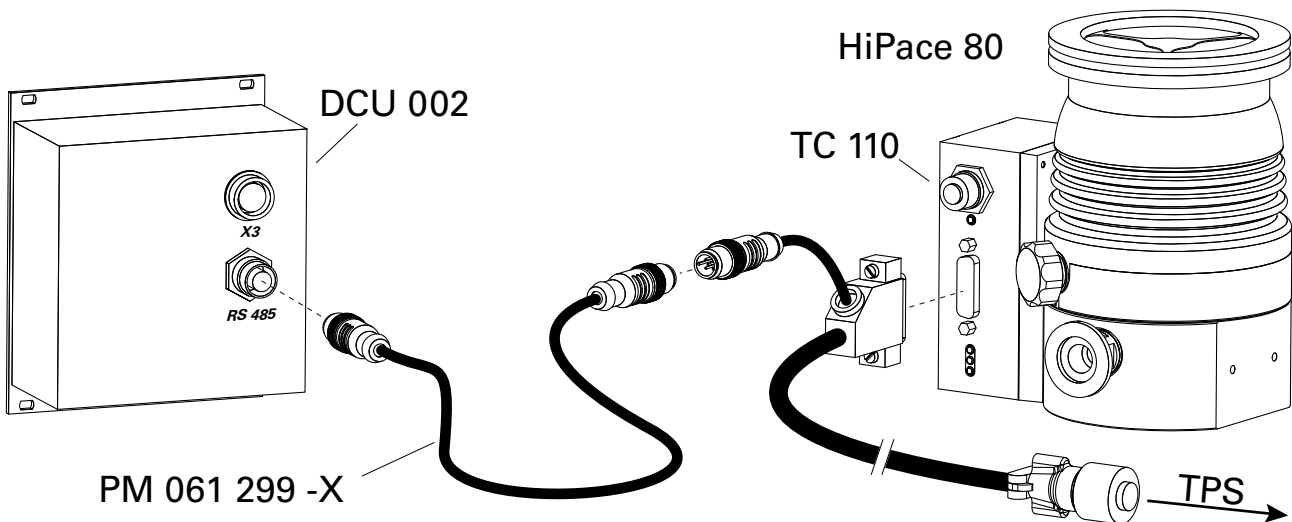

Fig. 6: Example: Connection of DCU 002 to Turbopump HiPace 80 using connecting cable

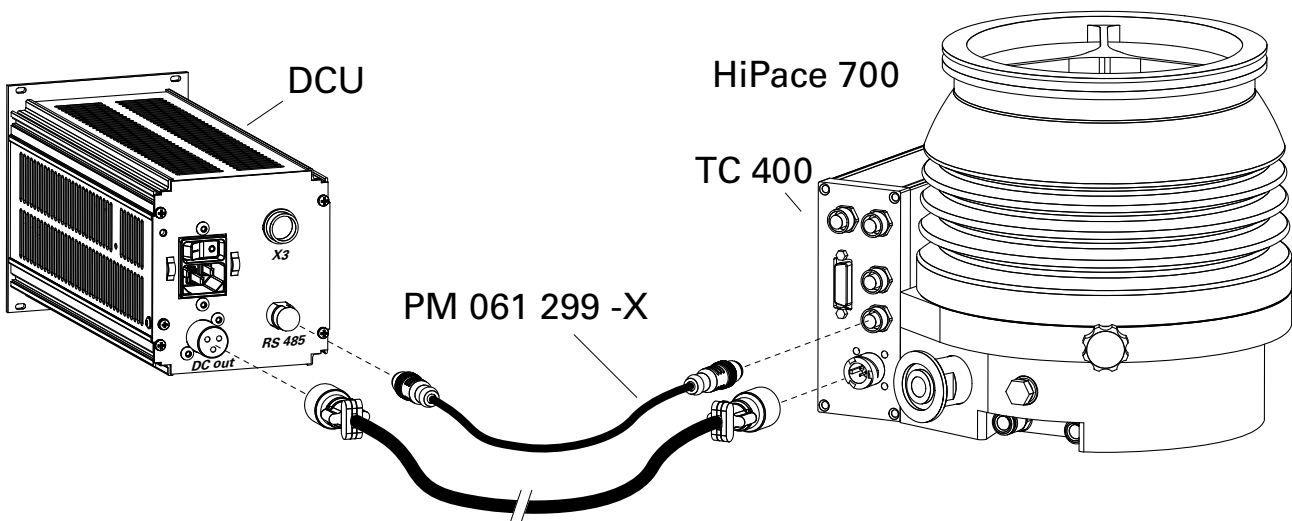
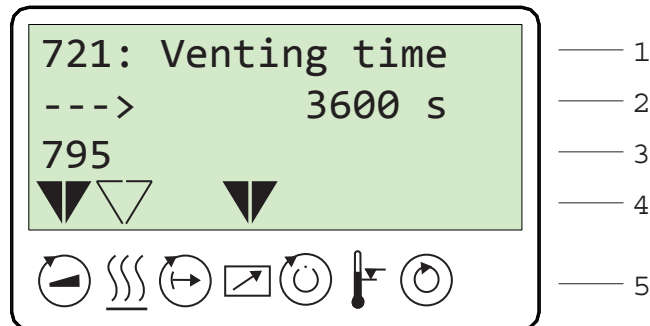

Fig. 7: Example: Connection of DCU with integrated power pack to Turbopump HiPace 700

6 Operation

6.1 LC-Display



The four line LCD visualizes the functions of theDCU.

Functions are assigned as follows:

- **Line 1:** Number and name of the selected parameter (e.g. 721: Vent time).
- **Line 2:** relevant value for the selected parameter. The arrow —> indicates Edit mode.
- **Line 3** with two functions:
 - Function 1: Current messages concerning operation and control will be displayed (See operating instructions for electronic drive unit and 7.2 Error codes).
 - Function 2: presentation of a required second parameter in the format [Parameter number: value]. The function for this line can be set via parameter [**P:795**] **Servicelin** in Line 1. All parameters can be accessed with "Servicelin". Error messages will be displayed independently of the selected function.
- **Line 4:** presentation of the current equipment status by arrows that point to the associated symbols.
- **Line 5:** Symbols (see below)

6.2 Symbol description

Symbol	Description	Arrow	Explanation
	Pump accelerates = [P:307]	-	NO
		▼	YES
	Preselection heating = [P:001]	-	No preselection
		▽	Preselection heating, switching point not reached
		▼	Heating On, switching point reached
	Standby = [P:002]	-	OFF
		▼	ON
	Equipment remote controlled = [P:300]	-	NO
		▼	YES
	Switching point reached = [P:302]	-	NO
		▼	YES
	Excess temperature	-	No excess temperatures
		▽	Excess temperature turbopump = [P:305]
		▽	Excess temperature turbo-electronics = [P:304]
		▼	Excess temperature turbopump and turbo-electronics
	Final speed reached = [P:306]	-	NO
		▼	YES

6.3 Button functions

Four short-travel keys (Softkeys) constitute the operator interface for the DCU.



Key	Application/Example	Explanation
		Reset (error acknowledgement) acknowledges errors (red LED illuminates)
	[309]: ActualSpd [308]: SetRotSpd	Scroll back through parameters Scrolls back one parameter
	[310]: DrvCurrent [311]: OpHrsPump	Scroll forwards through parameters Scrolls forwards one parameter
 Simultaneous	[001]: Heating →▶ off	Change value (Edit mode) Access to displayed value, if possible (Arrow→▶ is displayed)
	[001]: Heating on	Confirm value (Parameter selection mode) Accept changed value ("change confirmed" is displayed)
	[010]: PumpgStatn on / off	Pumping station ON/OFF switches pumping station on or off. corresponds to parameter [010]: "PumpgStatn"

6.4 Switching on



Ensure correct connection in the absence of display!

All connecting cables must always be connected to the electronic drive unit and the mains at DCU with integrated power supplies. Otherwise the correct functioning of the unit is not possible; there will be no operating display.

→ Connect all connecting cables for "RS485", "DCout" and "ACin".

→ Switch on the supply voltage with switch S1 on the DCU with integrated power pack, or when using a DCU 002 switch on via the provided power pack (e.g. TPS).

Self-test

The DCU carries out a self-test and a check of the connected units after switch-on. The duration of the self-test is approx. 20s and is visualized in the display with a progress bar.

- LC display test: All characters in the LC display go dark for a short time.
- LED test: The red and green LEDs illuminate during the self-test.
- Hardware test of the DCU
- Pump electronics connection test: The correct pump electronics connection and identity will be checked.
- Parameter check: Information on operating parameters will be loaded.
- Identification of the connected units: Electronic drive unit designation display. Pressure gauge designation display.
 - The "TPR" indication will appear in the display when a PCR 280 pressure gauge is connected.
- If no error has occurred, it is DCU ready to operate.
- The green LED flashes.

→ Reset malfunction messages using key , if necessary.

6.5 Operation

All function-relevant variables of a turbopump are anchored in the electronic drive unit as parameters. Each parameter has a three-digit number and a designation. Parameters can be used via Pfeiffer Vacuum display and control units or via RS-485 with the Pfeiffer Vacuum protocol.

The value of a parameter is always readable. Editable parameters are adjustment commands and target values (See the operating instructions for the respective electronic drive unit for this purpose).

Selecting the parameters

- Preselect parameter number using the (backwards) or (forwards) keys.
 - Fast scrolling by pressing and keeping the relevant key depressed.
- The selected parameter appears in line 1, the corresponding value in line 2.

Set parameters

- Select a parameter.
- Simultaneously press keys and .
- The edit mode for the selected parameter is active.
- At the beginning of the second line an arrow () appears.
- Using keys , to decrease or increase the value, respective to change options.
- Simultaneously press keys and .
- If line 3 = empty (see P:795), the following will be displayed: "change confirmed"
- The parameter is set.
- Edit mode for the parameter is ended. The arrow () disappears.

Edit mode(—▶) will disappear again automatically under the following conditions and without accepting the value to be changed:

- Input disruption or no key operation for more than 10s.
- If an error occurs.
- Key 6 "Pumping station ON/OFF" has been pressed.
- If line 3 = empty , "data not changed" will be displayed.

6.6 Operation with DCU



Parameter set and Pfeiffer Vacuum display and control unit

Pfeiffer Vacuum display and control units DCU show the basic parameter set by default. Furthermore the DCU contains parameters, which are not positioned in the electronic drive unit.

→ Parameter [P:794] = 1 (Display of all available parameters).

#	Display	Designation	Functions	Data type	Access	Unit	min	max	default	
340	Pressure	Active pressure value		7	R	mbar	1E-10	1E3		
350	Ctr Name	Type of display and control unit		4	R					
351	Ctr Software	Software of display and control unit		4	R					
738	Gaugetype	Type of pressure gauge		4	RW					
794	Param set	Parameterset	0 = basic parameter set 1 = extended parameter set	7	RW		0	1	0	
795	Servicelin	Insert service line		7	RW				795	

The display of further parameters depends on the type of electronic drive unit.



Start pump by pressing "Pumping station ON/OFF" key on the DCU

The "Pumping station" key only controls the parameter [P:010]. All components connected via the electronic drive unit will be activated or deactivated according to their configuration.

→ Ensure that the parameter [P:023] is also switched on for powering-up the turbo-pump.

6.7 Pressure measurement via DCU

Connection and use of a high vacuum gauge enables pressure measurement in the vacuum system via the DCU.



Pressure measurement with the DCU

An exact pressure measurement is not possible with the DCU. This is particularly true with linear gauges in the lower pressure range.

→ Use suitable measuring instrument.

Displaying the gauge type

→ Parameter [P:794] = 1 (Displaying the extended parameter set at the DCU)

→ Select or enter parameter [P:738] **Gaugetype**.

Gauges with identical surge impedance are only recognized by DCU as a group (e.g. CMR?). Manual input of the exact gauge type is also possible via the parameter [P:738].

Display example	Meaning
TPR 280	Gauge TPR 280 connected
CMR ?	Gauge of the CMR Group connected, exact type not yet set
none	No pressure gauge connected

Displaying the active pressure value

→ Parameter [P:794] = 1 (Displaying the extended parameter set at the DCU)

→ Select parameter [P:340] **Pressure**.

Display example	Meaning
———— mbar	No pressure gauge connected
< 5E-4mbar	Measuring range not reached (dependent on the pressure gauge used)
> 1E3mbar	Measuring range exceeded (dependent on the pressure gauge used)
6.3E-9mbar	Valid pressure measurement
id fam mbar	Gauge type not yet identified; see [P:340]
Error	Error in pressure gauge

6.8 Switching off

- Press key  on the DCU front panel.
- Cut of supply voltage with switch S1 on the DCU with integrated power pack, or when using a DCU 002 via the supplied power pack (e.g. TPS).

7 Malfunctions





Ensure correct connection in the absence of display!

All connecting cables must always be connected to the electronic drive unit and the mains at DCU with integrated power supplies. Otherwise the correct functioning of the unit is not possible; there will be no operating display.

→ Connect all connecting cables for "RS485", "DCout" and "ACin".

7.1 Operating mode display via LED

The red LED (error status) and green LED (operating status) on the front panel can accept the following states:

LED	Symbol	Permanent Off	Flashing (1/12 s active)	Flashing (1/2 s active)	Permanent On
Green		No adequate power supply	Pumping station "OFF"	Power failure	Pumping station "ON"
Red		No error	Warning		Errors

7.2 Error codes

Errors (** Error — **) always cause the connected peripheral devices to be switched off.

→ Eliminate error and reset by pressing keys  .

Warnings (* Warning — *) are only displayed and do not cause components to be switched off.

Error code	Problem	Remedy
* Warning F110 *	<ul style="list-style-type: none"> – Pressure gauge faulty – Pressure gauge removed during operation 	<ul style="list-style-type: none"> ⇒ Restart with gauge connected ⇒ Change pressure gauge ⇒ Install pressure gauge correctly
** Error E040 **	Hardware error: external RAM faulty	⇒ Contact Pfeiffer Vacuum Service.
** Error E042 **	Hardware error: EPROM check total	⇒ Contact Pfeiffer Vacuum Service.
** Error E043 **	Hardware error: E ² PROM write error	⇒ Contact Pfeiffer Vacuum Service.
** Error E090 **	<ul style="list-style-type: none"> – RAM not large enough – DCU is connected to incorrect pump electronics 	<ul style="list-style-type: none"> ⇒ Contact Pfeiffer Vacuum Service. ⇒ Connect correct pump electronics
** Error E698 **	The connected electronic drive unit does not respond	⇒ Contact Pfeiffer Vacuum Service.

Further error and warning messages are described in the Operating Instructions for the electronic drive unit.

8 Service

Pfeiffer Vacuum offers first-class service!

- Fast replacement with exchange products in mint condition
- Advice on the most cost-efficient and quickest solution

Detailed information, addresses and forms at: www.pfeiffer-vacuum.com (Service).

Service orders

All service orders are carried out exclusively according to our repair conditions for vacuum units and components.

9 Accessories

An overview about original Pfeiffer Vacuum accessories for the designated device can be found in the operating instructions of the respective vacuum pump.

10 Technical data and dimensions

10.1 Technical data

Parameter	DCU 002	
Connection	12-30 V DC	
Ambient temperature	5-50 °C	
Protection category	IP 20	
Power consumption	5 VA	
Weight	0.4 kg	

Parameter	DCU 110	DCU 180
Ambient temperature	5-50 °C	5-50 °C
Protection category	IP 20	IP 20
Mains requirement: frequency (range)	50/60 Hz	50/60 Hz
Mains requirement: power consumption	130 VA	210 VA
Mains requirement: voltage (range)	115-230 (-20-+15 %) V AC	115-230 (-20-+15 %) V AC
Output voltage	24 (± 2 %) V DC	24 (± 2 %) V DC
Output current	4.6 A	7.5 A
Weight	1.2 kg	1.7 kg

Parameter	DCU 310	DCU 400
Ambient temperature	5-50 °C	5-50 °C
Protection category	IP 20	IP 20
Mains requirement: frequency (range)	50/60 Hz	50/60 Hz
Mains requirement: power consumption	340 VA	450 VA
Mains requirement: voltage (range)	115-230 (-20-+15 %) V AC	115-230 (-20-+15 %) V AC
Output voltage	24 (± 2 %) V DC	48 (± 2 %) V DC
Output current	12.5 A	8.4 A
Weight	1.85 kg	2.3 kg

10.2 Dimensions

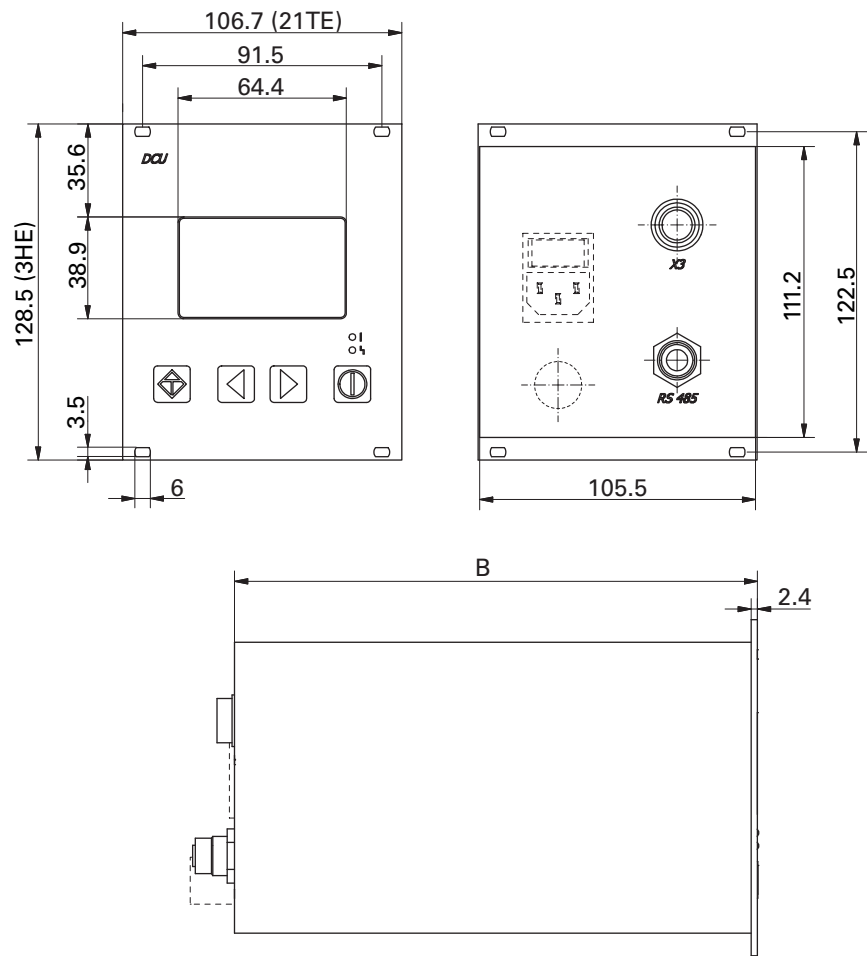

Dimension	DCU 002	DCU 110	DCU 180	DCU 310	DCU 400
B	52.5 mm	200.0 mm	230.0 mm	230.0 mm	230.0 mm



Declaration of conformity

according to the EC directive:

- **Electromagnetic Compatibility 2004/108/EC**
- **Low Voltage 2006/95/EEC**

We hereby certify, that the product specified below is in accordance with the provision of EU Electromagnetic Compatibility Directive **2004/108/EEC** and EU Low Voltage Directive **2006/95/EEC**.

DCU

DCU 002, 110, 180, 310, 400

Guidelines, harmonised standards and national standards and specifications which have been applied:

DIN EN 61000-3-2 : 2008
DIN EN 61000-3-3 : 2006
DIN EN 61010-1 : 2002
DIN EN 61326-1 : 2006
DIN EN 62061 : 2005
Semi F47-0200
Semi S2-0706

Signatures:

Pfeiffer Vacuum GmbH
Berliner Straße 43
35614 Asslar
Germany

(M. Bender)
Managing Director

(Dr. M. Wiemer)
Managing Director

CE/2011

**Vacuum solutions
from a single source**

Pfeiffer Vacuum stands for innovative and custom vacuum solutions worldwide, technological perfection, competent advice and reliable service.

**Complete range
of products**

From a single component to complex systems: We are the only supplier of vacuum technology that provides a complete product portfolio.

**Competence in
theory and practice**

Benefit from our know-how and our portfolio of training opportunities! We can support you with your plant layout and provide first-class on-site-service worldwide.

**Are you looking for a
perfect vacuum solution?
Please contact us**

Pfeiffer Vacuum GmbH
Headquarters • Germany
T +49 6441 802-0
info@pfeiffer-vacuum.de
www.pfeiffer-vacuum.com