



HPS™ Products

HPS™ Products

Series 943

Digital, Cold Cathode
Vacuum Sensor System



OPERATION AND MAINTENANCE MANUAL



HPS™ Products

HPS™ Products Series 943

Digital, Cold Cathode
Vacuum Sensor System

February 1998
Part # 100009887 Rev. A

Part # 943-__ - _____ - ____

Serial # _____

Please fill in these numbers and have them readily available when calling for service or additional information.

(The part number can be found on your packing slip, and the serial number is located on the rear of the housing.)

For more information or literature, contact:

MKS Instruments, Inc., HPS™ Products Inc.
5330 Sterling Drive
Boulder, CO 80301 USA

Phone: 303-449-9861
800-345-1967

FAX: 303-442-6880

© 1998 by MKS Instruments, Inc., HPS™ Products Inc., All rights reserved.

ALCONOX is a registered trademark of Alconox, Inc.
Elgiloy is a registered trademark of Elgiloy Co.
Igni Torr is a trademark and I-MAG is a registered trademark of MKS Instruments, Inc., Vacuum Products Group
Inconel is a registered trademark of Inco Alloys International, Inc.
OFHC is a registered trademark of AMAX, Inc.
Scotch-Brite is a trademark of 3M.
HPS™ is a trademark of MKS Instruments, Inc., Vacuum Products Group
VCR® is a registered trademark of Swagelok® Company.

Table of Contents

Table of Contents	
Package Contents	1
Safety Information	2
Symbols	2
Symbols Used in this Manual (English)	2
Symboles utilisés dans ce manuel (Français)	2
In dieser Betriebsanleitung vorkommende Symbole (Deutsch)	
Símbolos Usados en el Manual (Español)	3
Symbol Definitions	4
Definition of Symbols Found on the Unit (English)	4
Définition des symboles apparaissant sur l'appareil (Français)	4
Definitionen der am Gerät angebrachten Symbole (Deutsch)	5
Símbolos que Aparecen en la Unidad (Español)	5
Safety Precautions	6
Safety Procedures and Precautions (English)	6
Mesures de Sécurité et Mises en Garde (Français)	8
Sicherheitsvorschriften und Vorsichtsmaßnahmen (Deutsch)	10
Procedimientos y Precauciones de Seguridad (Español)	12
Specifications	14
Controller	14
Sensors	16
Feature and Control Locations	17
Typical Applications for the Series 943 System	18
About the HPS™ Products Series 943 Cold Cathode Vacuum Sensor System	19
Setting Up the Series 943 System	21
Using a Cold Cathode Sensor with the Series 943 Controller	21
Mounting the Controller	21
AC Power Cord	22
Fuse Replacement	22
Accessory Connector	23
Logarithmic Analog Output	23
Buffered Analog Output	24
Remote High Voltage Enable/Disable	24
Relay Inductive Loads and Arc Suppression	25
Operating the Series 943 System	26
Reading Pressure	26
Set Points	28
Adjusting the Set Points	28
Protect Set Point	29
Using the Series 943 System with Other Gases	30
Calibrating for Other Gases	31
Cleaning the Series 943 Controller Front Panel	32
Troubleshooting and Service	32
Returns	32
Maintaining the Series 943 System	32
Accessories	34

Product Warranty	36
Notes	37
Appendix A: Installing a	
Series 943 System Sensor	A.1
Locating a Cold Cathode Sensor	A.1
Orienting a Cold Cathode Sensor	A.1
Managing Contamination in a Cold Cathode Sensor	A.1
Testing a Cold Cathode Sensor	A.2
Connecting a Cold Cathode Sensor	A.2
Disassembling the I-MAG Sensor	A.3
Cleaning the I-MAG Sensor	A.3
Series 423 I-MAG® Cold Cathode Sensor	A.3
Assembling the I-MAG Sensor	A.5
Preparing the Sensor for Bakeout	A.6
Series 421 Cold Cathode Sensor	A.6
Disassembling the Series 421 Sensor	A.6
Cleaning the Series 421 Sensor	A.8
Assembling the Series 421 Sensor	A.8
Preparing the Sensor for Bakeout	A.9
Notes	A.10
Appendix B: How the	
Series 943 System Works	B.1
Theory of a Cold Cathode Ionization Sensor	B.1
Series 943 Circuit Description	B.3
High Voltage Power Supply	B.3
Electrometer	B.4
Analog Processing	B.4
Set Point Comparators	B.4
Microprocessor	B.4
Notes	B.5

Package Contents

Before unpacking your Series 943 Digital, Cold Cathode Vacuum Sensor System, check all surfaces of the packing material for shipping damage.

Please be sure that your Series 943 Controller package contains these items:

- ◆ 1 Series 943 Controller
- ◆ 1 female, 15-pin subminiature D ("D") Accessory connector kit
- ◆ 1 10-foot power cord (optional)
- ◆ 1 HPS™ Products Series 943 Digital, Cold Cathode Vacuum Sensor System User's Manual.

A complete Series 943 System includes a sensor and its connecting cable, sold separately. Please refer to page 34 for necessary ordering information.



If any items are missing from the package, call HPS™ Products Customer Service at 1-303-449-9861 or 1-800-345-1967.

Inspect the Series 943 System for visible evidence of damage. If it has been damaged in shipping, notify the carrier immediately. Keep all shipping materials and packaging for claim verification. Do not return the product to HPS™.

Safety Information

Symbols

Symbols Used in this Manual (English)

Symboles utilisés dans ce manuel (Français)

Definitions of CAUTION and NOTE messages used throughout the manual.

Définition des indications ATTENTION et REMARQUE utilisées dans ce manuel.



CAUTION: Risk of electrical shock. ISO 3864, No. B.3.6

ATTENTION: Risque de secousse électrique. ISO 3864, No. B.3.6



CAUTION: Refer to accompanying documents. ISO 3864, No. B.3.1

This sign denotes a hazard. It calls attention to a procedure, practice, condition, or the like, which, if not correctly performed or adhered to, could result in injury to personnel.

ATTENTION: Se reporter à la documentation. ISO 3864, No. B.3.1
L'indication signale un danger potentiel. Elle est destinée à attirer l'attention sur une procédure, une utilisation, une situation ou toute autre chose présentant un risque de blessure en cas d'exécution incorrecte ou de non-respect des consignes.



This sign denotes a hazard. It calls attention to an operating procedure, practice, or the like, which, if not correctly performed or adhered to, could result in damage to or destruction of all or part of the product.

L'indication signale un danger potentiel. Elle est destinée à attirer l'attention sur une procédure, une utilisation, une situation ou toute autre chose présentant un risque d'endommagement ou de dégât d'une partie ou de la totalité de l'appareil en cas d'exécution incorrecte ou de non-respect des consignes.



This sign denotes important information. It calls attention to a procedure, practice, condition, or the like, which is essential to highlight.

L'indication REMARQUE signale des informations importantes. Elle est destinée à attirer l'attention sur une procédure, une utilisation, une situation ou toute autre chose présentant un intérêt particulier.

In dieser Betriebsanleitung vorkommende Symbole (Deutsch)

Símbolos Usados en el Manual (Español)

Definition der mit VORSICHT! und HINWEIS überschriebenen Abschnitte in dieser Betriebsanleitung.

Definiciones de los mensajes de PRECAUCIÓN y OBSERVACIÓN usados en el manual.



VORSICHT! Stromschlaggefahr! ISO 3864, Nr. B.3.6

PRECAUCIÓN: Riesgo de descarga eléctrica. ISO 3864, N.º B.3.6



VORSICHT! Bitte Begleitdokumente lesen! ISO 3864, Nr. B.3.1

PRECAUCIÓN: Consultar los documentos adjuntos. ISO 3864, N.º B.3.1

Das Symbol VORSICHT! weist auf eine Gefahrenquelle hin. Es macht auf einen Arbeitsablauf, eine Arbeitsweise, einen Zustand oder eine sonstige Gegebenheit aufmerksam, deren unsachgemäße Ausführung bzw. Ungenügende Berücksichtigung zu Körperverletzung führen kann.

Esto símbolo indica un riesgo. Pone de relieve un procedimiento, práctica, condición, etc., que, de no realizarse u observarse correctamente, podría causar lesiones a los empleados.



Das Symbol VORSICHT! weist auf eine Gefahrenquelle hin. Es macht auf einen Bedienungsablauf, eine Arbeitsweise oder eine sonstige Gegebenheit aufmerksam, deren unsachgemäße Ausführung bzw. Ungenügende Berücksichtigung zu einer Beschädigung oder Zerstörung des Produkts oder von Teilen des Produkts führen kann.

Esto símbolo indica un riesgo. Pone de relieve un procedimiento, práctica, etc., de tipo operativo que, de no realizarse u observarse correctamente, podría causar desperfectos al instrumento, o llegar incluso a causar su destrucción total o parcial.

















Das Symbol HINWEIS weist auf eine wichtige Mitteilung hin, die auf einen Arbeitsablauf, eine Arbeitsweise, einen Zustand oder eine sonstige Gegebenheit von besonderer Wichtigkeit aufmerksam macht.

Esto símbolo indica información de importancia. Pone de relieve un procedimiento, práctica, condición, etc., cuyo conocimiento resulta esencial.















Symbol Definitions

Definition of Symbols
Found on the Unit
(English)

Définition des symboles
apparaissant sur
l'appareil (Français)

Caution refer to accompanying documents ISO 3864, No. B.3.1	Attention se reporter à la documentation ISO 3864, No. B.3.1	
Caution risk of electric shock ISO 3864, No. B.3.6	Attention risque de secousse électrique ISO 3864, No. B.3.6	
Caution hot surface IEC 417, No. 5041	Attention surface brûlante IEC 417, No. 5041	
On (Supply) IEC 417, No. 5007	Marche (mise sous tension) IEC 417, No. 5007	
Off (Supply) IEC 417, No. 5008	Arrêt (hors tension) IEC 417, No. 5008	
Earth (Ground) IEC 417, No. 5017	Terre IEC 417, No. 5017	
Protective Earth (Ground) IEC 417, No. 5019	Terre de protection IEC 417, No. 5019	
Direct Current IEC 417, No. 5031	Courant continu IEC 417, No. 5031	
Alternating Current IEC 417, No. 5032	Courant alternatif IEC 417, No. 5032	
Both Direct and Alternating Current IEC 417, No. 5033-a	Courant continu et alternatif IEC 417, No. 5033-a	
Three-phase Alternating Current IEC617-2, No. 020206	Courant alternatif triphasé IEC617-2, No. 020206	
Equipotentiality IEC 417, No. 5021	Equipotentialité IEC 417, No. 5021	
Frame or Chassis IEC 417, No. 5020	Masse, Châssis IEC 417, No. 5020	
Class II Equipment IEC 417, No. 5172-a	Matériel de la Classe II IEC 417, No. 5172-a	

Definitionen der am Gerät angebrachten Symbole (Deutsch) Símbolos que Aparecen en la Unidad (Español)

	Vorsicht! Bitte Begleitdokumente lesen! ISO 3864, Nr. B.3.1	Precaución Consultar los documentos adjuntos ISO 3864, N.º B.3.1
	Vorsicht! Stromschlaggefahr! ISO 3864, Nr. B.3.6	Precaución Riesgo de descarga eléctrica ISO 3864, N.º B.3.6
	Vorsicht! Heiße Fläche! IEC 417, Nr. 5041	Precaución Superficie caliente IEC 417, N.º 5041
	Ein (Netz) IEC 417, Nr. 5007	Encendido (alimentación eléctrica) IEC 417, N.º 5007
	Aus (Netz) IEC 417, Nr. 5008	Apagado (alimentación eléctrica) IEC 417, N.º 5008
	Erde IEC 417, Nr. 5017	Puesta a tierra IEC 417, N.º 5017
	Schutzleiter IEC 417, Nr. 5019	Protección a tierra IEC 417, N.º 5019
	Gleichstrom IEC 417, Nr. 5031	Corriente continua IEC 417, N.º 5031
	Wechselstrom IEC 417, Nr. 5032	Corriente alterna IEC 417, N.º 5032
	Wechselstrom und Gleichstrom IEC 417, Nr. 5033-a	Corriente continua y alterna IEC 417, N.º 5033-a
	Drehstrom IEC 617-2 Nr. 020206	Corriente alterna trifásica IEC 617-2 N.º 020206
	Äquipotentialanschluß IEC 417, Nr. 5021	Equipotencialidad IEC 417, N.º 5021
	Rahmen oder Chassis IEC 417, Nr. 5020	Caja o chasis IEC 417, N.º 5020
	Geräteklasse II IEC 417, Nr. 5172-a	Equipo de clase II IEC 417, N.º 5172-a

Safety Precautions

Safety Procedures and Precautions (English)

The following general safety precautions must be observed during all phases of operation of this instrument. Failure to comply with these precautions or with specific warnings elsewhere in this manual violates safety standards of intended use of the instrument and may impair the protection provided by the equipment. MKS Instruments, Inc. assumes no liability for the customer's failure to comply with these requirements.



Properly ground the Controller.

This product is grounded through the grounding conductor of the power cord. To avoid electrical shock, plug the power cord into a properly wired receptacle before connecting it to the product input or output terminals. A protective ground connection by way of the grounding conductor in the power cord is essential for safe operation.

Upon loss of the protective-ground connection, all accessible conductive parts (including knobs and controls that may appear to be insulating) can render an electrical shock.



Do not substitute parts or modify instrument.

Do not install substitute parts or perform any unauthorized modification to the instrument. Return the instrument to an MKS Calibration and Service Center for service and repair to ensure that all safety features are maintained.



Use proper electrical fittings.

Dangerous voltages are contained within this instrument. All electrical fittings and cables must be of the type specified, and in good condition. All electrical fittings must be properly connected and grounded.



The Series 943 Controller contains high voltages when on.

High voltage is present in the cable and at the cold cathode sensor when the Controller is turned on.



Use the proper power source.

This product is intended to operate from a power source that applies a voltage between the supply conductors, or between either of the supply conductors and ground, less than or equal to of that specified in the manual.



Use the proper fuse.

Use only a fuse of the correct type, voltage rating, and current rating, as specified for your product.



Do not operate in explosive environments.

To avoid explosion, do not operate this product in an explosive environment unless it has been specifically certified for such operation.



Service by qualified personnel only.

Operating personnel must not remove instrument covers. Component replacement and internal adjustments must be made by qualified service personnel only.



Use the proper power cord.

Use only a power cord that is in good condition and which meets the input power requirements specified in the manual.

Use only a detachable cord set with conductors that have a cross-sectional area equal to or greater than 0.75 mm². The power cable should be approved by a qualified agency such as VDE, Semko, or SEV.

Mesures de Sécurité et Mises en Garde (Français)

Prendre toutes les précautions générales suivantes pendant toutes les phases d'utilisation de cet appareil. Le non-respect de ces précautions ou des avertissements contenus dans ce manuel entraîne une violation des normes de sécurité relatives à l'utilisation de l'appareil et le risque de réduire le niveau de protection fourni par l'appareil. MKS Instruments, Inc. ne prend aucune responsabilité pour les conséquences de tout non-respect des consignes de la part de ses clients.



Mise à la terre de l'appareil.

Cet appareil est mis à la terre à l'aide du fil de terre du cordon d'alimentation. Pour éviter tout risque de secousse électrique, brancher le cordon d'alimentation sur une prise de courant correctement câblée avant de le brancher sur les bornes d'entrée ou de sortie de l'appareil. Une mise à la terre de protection à l'aide du fil de terre du cordon d'alimentation est indispensable pour une utilisation sans danger de l'appareil.

En cas de défaut de terre, toutes les pièces conductrices accessibles (y compris les boutons de commande ou de réglage qui semblent être isolés) peuvent être source d'une secousse électrique.



Ne pas substituer des pièces ou modifier l'appareil.

Ne pas utiliser de pièces détachées autres que celles vendues par MKS Instruments, Inc. ou modifier l'appareil sans l'autorisation préalable de MKS Instruments, Inc. Renvoyer l'appareil à un centre d'étalonnage et de dépannage MKS pour tout dépannage ou réparation afin de s'assurer que tous les dispositifs de sécurité sont maintenus.



Mise à la terre et utilisation correcte d'accessoires électriques.

Des tensions dangereuses existent à l'intérieur de l'appareil. Tous les accessoires et les câbles électriques doivent être conformes au type spécifié et être en bon état. Tous les accessoires électriques doivent être correctement connectés et mis à la terre.



Danger de haute tension.

Une haute tension est présente dans le câble et dans le capteur lorsque le contrôleur est sous tension.



Utilisation d'une alimentation appropriée.

Cet appareil est conçu pour fonctionner en s'alimentant sur une source de courant électrique n'appliquant pas une tension entre les conducteurs d'alimentation, ou entre les conducteurs d'alimentation et le conducteur de terre, supérieure à celle spécifiée dans le manuel.



Utilisation d'un fusible approprié.

Utiliser uniquement un fusible conforme au type, à la tension nominale et au courant nominal spécifiés pour l'appareil.



Ne pas utiliser dans une atmosphère explosive.

Pour éviter tout risque d'explosion, ne pas utiliser l'appareil dans une atmosphère explosive à moins qu'il n'ait été approuvé pour une telle utilisation.



Dépannage effectué uniquement par un personnel qualifié.

L'opérateur de l'appareil ne doit pas enlever le capot de l'appareil. Le remplacement des composants et les réglages internes doivent être effectués uniquement par un personnel d'entretien qualifié.



Utilisation d'un cordon d'alimentation approprié.

Utiliser uniquement un cordon d'alimentation en bon état et conforme aux exigences de puissance d'entrée spécifiées dans le manuel.

Utiliser uniquement un cordon d'alimentation amovible avec des conducteurs dont la section est égale ou supérieure à 0,75 mm². Le cordon d'alimentation doit être approuvé par un organisme compétent tel que VDE, Semko ou SEV.

Sicherheitsvorschriften und Vorsichtsmaßnahmen (Deutsch)

Die untenstehenden allgemeinen Sicherheitsvorschriften sind bei allen Betriebsphasen dieses Instruments zu befolgen. Jede Mißachtung dieser Sicherheitsvorschriften oder sonstiger spezifischer Warnhinweise in dieser Betriebsanleitung stellt eine Zuwiderhandlung der für dieses Instrument geltenden Sicherheitsstandards dar und kann die an diesem Instrument vorgesehenen Schutzvorrichtungen unwirksam machen. MKS Instruments, Inc. haftet nicht für eine Mißachtung dieser Sicherheitsvorschriften seitens des Kunden.



Produkt erden!

Dieses Produkt ist mit einer Erdleitung und einem Schutzkontakt am Netzstecker versehen. Um der Gefahr eines elektrischen Schlages vorzubeugen, ist das Netzkabel an einer vorschriftsmäßig geerdeten Schutzkontaktsteckdose anzuschließen, bevor es an den Eingangs- bzw. Ausgangsklemmen des Produkts angeschlossen wird. Das Instrument kann nur sicher betrieben werden, wenn es über den Erdleiter des Netzkabels und einen Schutzkontakt geerdet wird.

Geht die Verbindung zum Schutzleiter verloren, besteht an sämtlichen zugänglichen Teilen aus stromleitendem Material die Gefahr eines elektrischen Schlages. Dies gilt auch für Knöpfe und andere Bedienelemente, die dem Anschein nach isoliert sind.



Keine Teile austauschen und keine Veränderungen vornehmen!

Bauen Sie in das Instrument keine Ersatzteile ein, und nehmen Sie keine eigenmächtigen Änderungen am Gerät vor! Schicken Sie das Instrument zu Wartungs- und Reparaturzwecken an einen MKS-Kalibrierungs- und Kundendienst ein! Dadurch wird sicher-gestellt, daß alle Sicherheitseinrichtungen voll funktionsfähig bleiben.



Erdung und Verwendung geeigneter elektrischer Armaturen!

In diesem Instrument liegen gefährliche Spannungen an. Alle verwendeten elektrischen Armaturen und Kabel müssen dem angegebenen Typ entsprechen und sich in einwand-freiem Zustand befinden. Alle elektrischen Armaturen sind vorschriftsmäßig anzubringen und zu erden.



Hochspannungsgefahr!

Bei eingeschaltetem Steuerteil liegt im Kabel und im Sensor Hochspannung an.



Richtige Stromquelle verwenden!

Dieses Produkt ist für eine Stromquelle vorgesehen, bei der die zwischen den Leitern bzw. zwischen jedem der Leiter und dem Masseleiter anliegende Spannung den in dieser Betriebsanleitung angegebenen Wert nicht überschreitet.

**Richtige Sicherung benutzen!**

Es ist eine Sicherung zu verwenden, deren Typ, Nennspannung und Nennstromstärke den Angaben für dieses Produkt entsprechen.



Gerät nicht in explosiver Atmosphäre benutzen!

Um der Gefahr einer Explosion vorzubeugen, darf dieses Gerät nicht in der Nähe explosiver Stoffe eingesetzt werden, sofern es nicht ausdrücklich für diesen Zweck zertifiziert worden ist.



Wartung nur durch qualifizierte Fachleute!

Das Gehäuse des Instruments darf vom Bedienpersonal nicht geöffnet werden. Das Auswechseln von Bauteilen und das Vornehmen von internen Einstellungen ist nur von qualifizierten Fachleuten durchzuführen.



Richtiges Netzkabel verwenden!

Das verwendete Netzkabel muß sich in einwandfreiem Zustand befinden und den in der Betriebsanleitung enthaltenen Anschlußwerten entsprechen.

Das Netzkabel muß abnehmbar sein. Der Querschnitt der einzelnen Leiter darf nicht weniger als 0,75 mm² betragen. Das Netzkabel sollte einen Prüfvermerk einer zuständigen Prüfstelle tragen, z.B. VDE, Semko oder SEV.

Procedimientos y Precauciones de Seguridad (Español)

Las precauciones generales de seguridad que figuran a continuación deben observarse durante todas las fases de funcionamiento del presente instrumento. La no observancia de dichas precauciones, o de las advertencias específicas a las que se hace referencia en el manual, contraviene las normas de seguridad referentes al uso previsto del instrumento y podría impedir la protección que proporciona el instrumento. MKS Instruments, Inc., no asume responsabilidad alguna en caso de que el cliente haga caso omiso de estos requerimientos.



Puesta a tierra del instrumento.

Este instrumento está puesto a tierra por medio del conductor de tierra del cable eléctrico. Para evitar descargas eléctricas, enchufar el cable eléctrico en una toma debidamente instalada, antes de conectarlo a las terminales de entrada o salida del instrumento. Para garantizar el uso sin riesgos del instrumento resulta esencial que se encuentre puesto a tierra por medio del conductor de tierra del cable eléctrico.

Si se pierde la conexión protectora de puesta a tierra, todas las piezas conductoras a las que se tiene acceso (incluidos los botones y mandos que pudieran parecer estar aislados) podrían producir descargas eléctricas.



No utilizar piezas no originales ni modificar el instrumento.

No se debe instalar piezas que no sean originales ni modificar el instrumento sin autorización. Para garantizar que las prestaciones de seguridad se observen en todo momento, enviar el instrumento al Centro de servicio y calibración de MKS cuando sea necesaria su reparación y servicio de mantenimiento.



Usar los accesorios eléctricos adecuados.

Este instrumento funciona con voltajes peligrosos. Todos los accesorios y cables eléctricos deben ser del tipo especificado y mantenerse en buenas condiciones. Todos los accesorios eléctricos deben estar conectados y puestos a tierra del modo adecuado.



Peligro por alto voltaje.

Cuando el controlador está encendido, se registra alto voltaje en el cable y en el sensor.



Usar la fuente de alimentación eléctrica adecuada.

Este instrumento debe funcionar a partir de una fuente de alimentación eléctrica que no aplique más voltaje entre los conductores de suministro, o entre uno de los conductores de suministro y la puesta a tierra, que el que se especifica en el manual.



Usar el fusible adecuado.

Usar únicamente un fusible del tipo, clase de voltaje y de corriente adecuados, según lo que se especifica para el instrumento.



Evitar su uso en entornos explosivos.

Para evitar el riesgo de explosión, no usar este instrumento o en un entorno explosivo, a no ser que haya sido certificado para tal uso.



Reparaciones efectuadas únicamente por técnicos especializados.

Los operarios no deben retirar las cubiertas del instrumento. El cambio de piezas y los reajustes internos deben efectuarlos únicamente técnicos especializados.



Usar el cable eléctrico adecuado.

Usar únicamente un cable eléctrico que se encuentre en buenas condiciones y que cumpla los requisitos de alimentación de entrada indicados en el manual.

Usar únicamente un cable desmontable instalado con conductores que tengan un área de sección transversal equivalente o superior a 0,75mm². El cable eléctrico debe estar aprobado por una entidad autorizada como, por ejemplo, VDE, Semko o SEV.

Specifications

Controller

Measuring Range	1.0 x 10 ⁻¹⁰ to 1.0 x 10 ⁻² Torr 1.3 x 10 ⁻¹⁰ to 1.3 x 10 ⁻² mbar 1.3 x 10 ⁻⁸ to 1.3 Pa
Set Point Range	2.0 x 10 ⁻⁹ to 9.0 x 10 ⁻³ Torr 2.7 x 10 ⁻⁹ to 1.2 x 10 ⁻² mbar 2.7 x 10 ⁻⁷ to 1.2 Pa
Operating Temperature Range	5° to 40°C (41° to 104°F)
Storage Temperature Range	-10° to 55°C (14° to 131°F)
Relative Humidity	80% maximum for temperatures less than 31°C, decreasing linearly to 50% maximum at 40°C
Altitude	2000 m (6561 ft) maximum
Insulation Coordination	Installation (Overvoltage) Category II, Pollution Degree 2
Mains Voltage	Fluctuations not to exceed ±10%
Power Requirement	100 to 120 VAC, 50/60 Hz or 230 VAC, 50/60 Hz
Power Consumption	9 W
Analog Output Voltage <i>Buffered</i> <i>Logarithmic</i>	0 to 9 VDC 1 to 9 VDC (1 V per decade)
Fuse Rating, Size	T 0.16 A for 100 to 120 VAC T 0.063 A for 220 to 240 VAC Ø 5 mm x 20 mm for all
Number of Channels	1
Process Control	2 independently adjustable relay set points
Relay Contact Rating	SPDT, resistive load 1 A @ 30 VAC or 24 VDC

Relay Response	50 msec for pressures $>10^{-8}$ Torr
Front Panel Controls	Power on-off rocker switch, 2 push-buttons and potentiometers for independent relay set point viewing and adjustment, 1 push-button and potentiometer for protection set point viewing and adjustment, toggle switch for high voltage (On/Off/Remote)
Display	Red LED, 7-segment digits 14 mm in height, $\pm 60^\circ$ viewing angle
<i>Resolution</i>	2 digits (1 leading) with $1\frac{1}{2}$ -digit signed exponent
<i>Units</i>	Shown in either Torr, mbar, or Pascal
<i>Update Rate</i>	250 msec
Indicators	Red LEDs for set points
Electronic Casing	Aluminum, anodized
Dimensions (W x D x H)	$3\frac{3}{4}$ " x 7" x $3\frac{3}{4}$ " (96 mm x 178 mm x 96 mm)
Size	$\frac{1}{4}$ DIN
Weight	2.2 lb (1.0 kg)
Product Safety	CE Mark 89/336/EEC EMC Directive 73/23/EEC Low Voltage Directive

Sensors

Cold Cathode Sensor Type	Series 421 or Series 423 I-MAG® isolated collector, inverted magnetron
Response Time	40 msec
Reproducibility	5% of indicated pressure at constant temperature
Calibration Gas	Air/nitrogen
Installation Orientation	Any (port down suggested)
Materials Exposed to Vacuum	Series 421 – Stainless steel, Al 6061, silver-copper brazing alloy, alumina ceramic, Elgiloy®, OFHC® copper Series 423 – SS 302, SS 304, glass, Al, Inconel® X-750, alumina ceramic
Maximum Internal Volume	Series 421 - 1.8 in. ³ (30 cm ³) Series 423 - 0.9 in. ³ (15 cm ³)
Operating Temperature Range	0° to 70°C (32° to 158°F)
Maximum Bakeout Temperature (Without Controller or Cables)	Series 421 – 250°C (482°F) when backshell subassembly removed, 125°C (257°F) otherwise ; Series 423 – 500°C (932°F) for CF flange model, magnet removed
Diameter	Series 421 – 2.2 in. (56 mm) Series 423 – 2.6 in. (66 mm)
Length	Series 421 – 6.3 in. (160 mm) Series 423 – 3.4 in. (86 mm)
Typical Weight (with 2¾" CF Flange)	421 - 2.4 lb (1.1 kg) 423 - 1.8 lb (0.8 kg)
Vacuum Connection	KF 25 KF 40 2¾" CF (423 - rotatable) 8 VCR®-F (½") 1" tubing

Feature and Control Locations

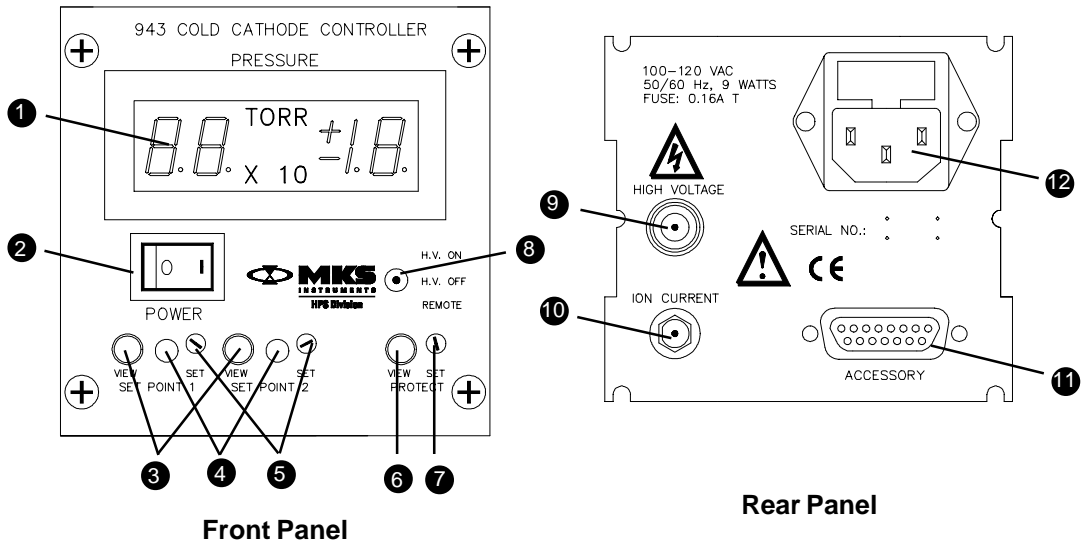

- 1 Digital LED Display
- 2 Power On-Off Rocker Switch
- 3 View Set Point Push-buttons
- 4 LED Set Point Indicators
- 5 Set Point Adjustment Potentiometers
- 6 View Protect Set Point Push-button
- 7 Protect Set Point Adjustment Potentiometer
- 8 High Voltage Toggle Switch (*H.V. On / H.V. Off / Remote*)
- 9 High Voltage SHV Connector
- 10 Ion Current SMA Connector
- 11 Male, 15-pin "D" Accessory Connector
- 12 AC Power Inlet, IEC 320 w/ Fuse Holder

See Appendix A for Sensors

Typical Applications for the Series 943 System

- ◆◆ **Measurement** of high vacuum chamber pressures
- ◆◆ **Control** of high vacuum systems and process sequencing using relay set points
- ◆◆ **Sensing abnormal pressure** and taking appropriate security measures using relay set points
- ◆◆ **Controlling system pressure** using analog output as input to an automatic pressure controller
- ◆◆ **Starting or stopping system processes** with relay set points
- ◆◆ **Measuring** pressures of backfilled gases

About the HPS™ Products Series 943 Cold Cathode Vacuum Sensor System

The Series 943 Digital, Cold Cathode Vacuum Sensor System provides accurate and reliable data for processes which need pressure measurement from 10^{-10} Torr up to 10^{-2} Torr. The System is easy to use and is designed for versatility, reliability, and economy.

The Series 943 Controller is useful either as a small system controller or as a module in more sophisticated pressure control environments. The Controller features two standard relay set points for process applications and a high voltage set point (protect set point) to protect a sensor at higher pressures.

The pressure readout is a large, easy-to-read LED digital display. LEDs indicate the status of relay set points, which are independently adjusted using both a push-button and a potentiometer on the front panel. The set points are nonvolatile and remain unchanged after power down or failure. The protect set point works in a similar fashion.

Relay contacts and two analog output signals are accessible from the *Accessory* port on the rear panel. One analog output signal is digitally processed for the functional simplicity of a logarithmic curve, and one is buffered to provide a faster response time.

The Series 943 Controller's anodized aluminum casing provides good shielding against outside electrical interference.

The Controller easily mounts into a $\frac{1}{4}$ DIN panel cutout or stands alone. All controls, even the power switch, are conveniently accessed from the front panel, and cables are connected and hidden to the rear of the Controller.



Available sensors for the Series 943 Controller include the Series 423 I-MAG® and the Series 421 inverted magnetron, both isolated collector tubes. The design of these sensors increases the measurement range and reduces susceptibility to contamination. The sensors have no filaments to break or burn out.

The sensors are available with several standard fittings for vacuum connection and can be located away from the Controller using a cold cathode sensor cable as long as 300 feet in length.

Setting Up the Series 943 System

Using a Cold Cathode Sensor with the Series 943 Controller

See **Appendix A** for Series 421 or Series 423 sensor use with the Series 943 Controller.

Mounting the Controller

The Series 943 Controller is designed for either panel mounting or stand-alone use.

An optional hardware kit is available for mounting the Controller into a standard ¼ DIN cutout in a panel up to ³/16-inch thick (see **Accessories**, p. 34). A dimensioned illustration below shows the required cutout. Leave at least 3 inches of clearance behind the Controller to accommodate the connectors and cables.

To mount the Controller into the panel,

- 1 Slip it through the cutout in the front.
- 2 Slide the panel mounting brackets into the slots on both sides of the Controller from the rear.
- 3 Secure them with the thumbscrews provided.

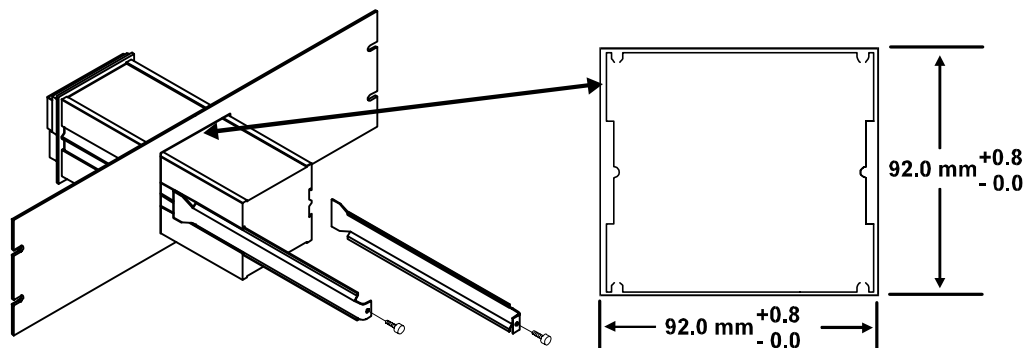

Panel mounting system with a ¼ DIN cutout

Adhesive backed rubber feet for benchtop use are also included in the mounting kit.

- 1 Remove the adhesive backing from each foot.
- 2 Apply one to each corner of the aluminum bottom surface.

AC Power Cord

The Series 943 Controller may be ordered with a North American, standard 120 VAC, 50/60 Hz power cord with a female IEC 320 connector.

If the Controller is ordered without a power cord, use only a harmonized, detachable cord set with conductors having a cross-sectional area equal to or greater than 0.75 mm². The power cord should be approved by a qualified agency such as VDE, Semko, or SEV.



Properly ground the Controller and vacuum system.

The Controller is grounded through the ground conductor of the power cord. If the protective ground connection is lost, all accessible conductive parts may pose a risk of electrical shock. Plug the cord into a properly grounded outlet only.



Do not exceed the rated line voltage of your unit. Electrical shock may result.

Fuse Replacement

The Series 943 Controller has a combined fuse holder and power inlet on the rear panel. Replace the fuse following the steps below.

- 1 Unplug the power cord from the power source and the Controller.
- 2 Snap out the fuse holder drawer.
- 3 Replace the fuse(s) with one of the following time-lag fuses:
 - ◆ T 0.16 A (Ø 5 mm x 20 mm) – 100 to 120 VAC
 - ◆ T 0.063 A (Ø 5 mm x 20 mm) – 220 to 240 VAC.
- 4 Close and secure the fuse holder drawer.

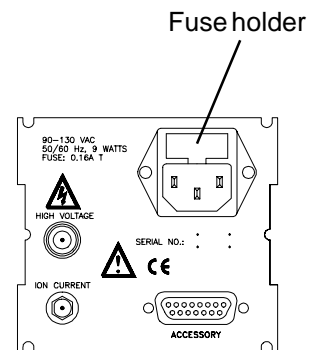

Rear Panel

Accessory Connector

Relay set point contacts, analog output voltage, and high voltage remote disabling can be accessed from the *Accessory* port on the rear panel of the Controller. A connector kit to mate to the port is provided. The figure and chart below identify the pin functions of the *Accessory* connector.

Accessory Connector	
Pin	Description
1	set point relay 1 - normally closed contact
2	set point relay 1 - common
3	set point relay 1 - normally open contact
4	set point relay 2 - normally closed contact
5	set point relay 2 - common
6	set point relay 2 - normally open contact
7	not used
8	not used
9	high voltage - disable
10	ground, high voltage - disable
11	analog output voltage, logarithmic (+)
12	analog output voltage, logarithmic (-)
13	analog output voltage, buffered (+)
14	analog output voltage, buffered (-)
15	not used

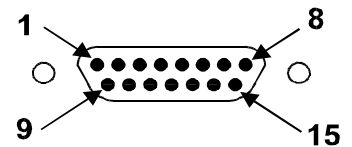

**Male, 15-pin "D"
Accessory connector**



Do not inadvertently short circuit the set point relay terminals to the analog output voltage.

If both the analog output and the high voltage enable are being used, use separate ground wires for each and connect them only at the *Accessory* port. Otherwise, the analog voltage may be incorrect.

Logarithmic Analog Output

Connecting to pins 11 and 12 provides a logarithmically-scaled, pressure dependent voltage V_o from 1 to 9 V. Pressure P can be calculated using the following equation,

$$P = 10(V_o - 11)$$

where,

V_o is in volts

P is in Torr.

For example, if $V_o = 5$ V, then $P = 10^{(5-11)} = 10^{-6}$ Torr

This output is provided by a microcontroller driving a D/A converter and has a response time of about 0.25 sec.

If $V_o =$	Then:
0 V	Controller is off
0.5 V	Display reads LO x 10 ⁻¹⁰ Torr
9 V	Display reads HI x 10 ⁻² Torr
9.5 V	High voltage turned off by protection set point
10 V	High voltage is off

Buffered Analog Output

A pressure dependent voltage V_o , with a range of 0 to 9 V, is provided on pins 13 and 14. Pressure can be determined using the graph shown on page 27.

This output is simply a buffered output of the sensor circuit and has a fast response time of less than 50 msec above 1.0 x 10⁻⁸ Torr.

Remote High Voltage Enable/Disable

The cold cathode sensor's high voltage may be turned off or on using a set point from a low vacuum sensor, such as a Pirani or convection Pirani. Use pins 9 and 10 to connect the Controller to the sensor for this external control.

To use this input, toggle the high voltage switch to *Remote*. Then,

If the high voltage is disabled by the protect set point, the *Remote* connection must be set to first disable and then enable the high voltage in order to turn it back on.

If Pin 9 is:	High Voltage is:
Disconnected or Connected to a "logic hi" of +5 V	On (sensor enabled)
Connected to pin 10 through a switch or relay contact or Connected to a "logic low" of 0 V	Off (sensor disabled)

Relay Inductive Loads and Arc Suppression

If the set point relays are used to switch inductive loads, e.g., solenoids, relays, transformers, etc., the arcing of the relay contacts may interfere with Controller operation or reduce relay contact life. Therefore an arc suppression network, shown schematically below, is recommended. The values of the capacitance C and the resistance R are calculated by the equations,

$$C = \frac{I^2}{10} \quad \text{and} \quad R = \frac{E}{10 \cdot I^a}$$

where,

$$a = 1 + (50/E)$$

C is in microfarads

R is in ohms

I is DC or AC_{peak} load current in amperes

E is DC or AC_{peak} source voltage in volts.

Note that,

$$C_{min} = 0.001 \text{ mF} \quad \text{and} \quad R_{min} = 0.5 \text{ W.}$$

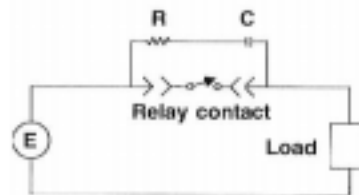

Relay arc suppression network

Operating the Series 943 System



Do not use this equipment in a manner inconsistent with manufacturer's specifications as this may impair the inherent protection provided by the equipment.

Reading Pressure



A sensor must be connected to the Controller before turning it on.

- 1 Set the Controller's high voltage switch to *H.V. Off*.
- 2 Turn on the power switch.

OFF will appear on the display. If the high voltage switch was left in the *H.V. On* or *H.V. Remote* position before power on, PRO (Protect) will appear.

Once the system pressure is less than or equal to 10^{-2} Torr, the Series 943 Controller is ready to measure pressure.

- 3 Set the high voltage switch to *H.V. On*.

After the discharge starts (start times vary), a pressure reading will appear on the front panel.

The graph and table on pages 27 and 28, respectively, represent the Series 943 System's voltage output as a function of pressure for nitrogen.

A phenomenon known as "rollback" may occur if a cold cathode sensor is used for pressure readings above 10^{-2} Torr. As pressure increases, the discharge in the sensor goes out. The pressure reading decreases or "rolls back", even though the pressure continues to increase. At some point, LO appears on the Controller display.

Operating the sensor at pressures above 10^{-2} Torr will not only give an incorrect reading but may also damage the sensor (refer to **Protect Set Point**, p. 29).

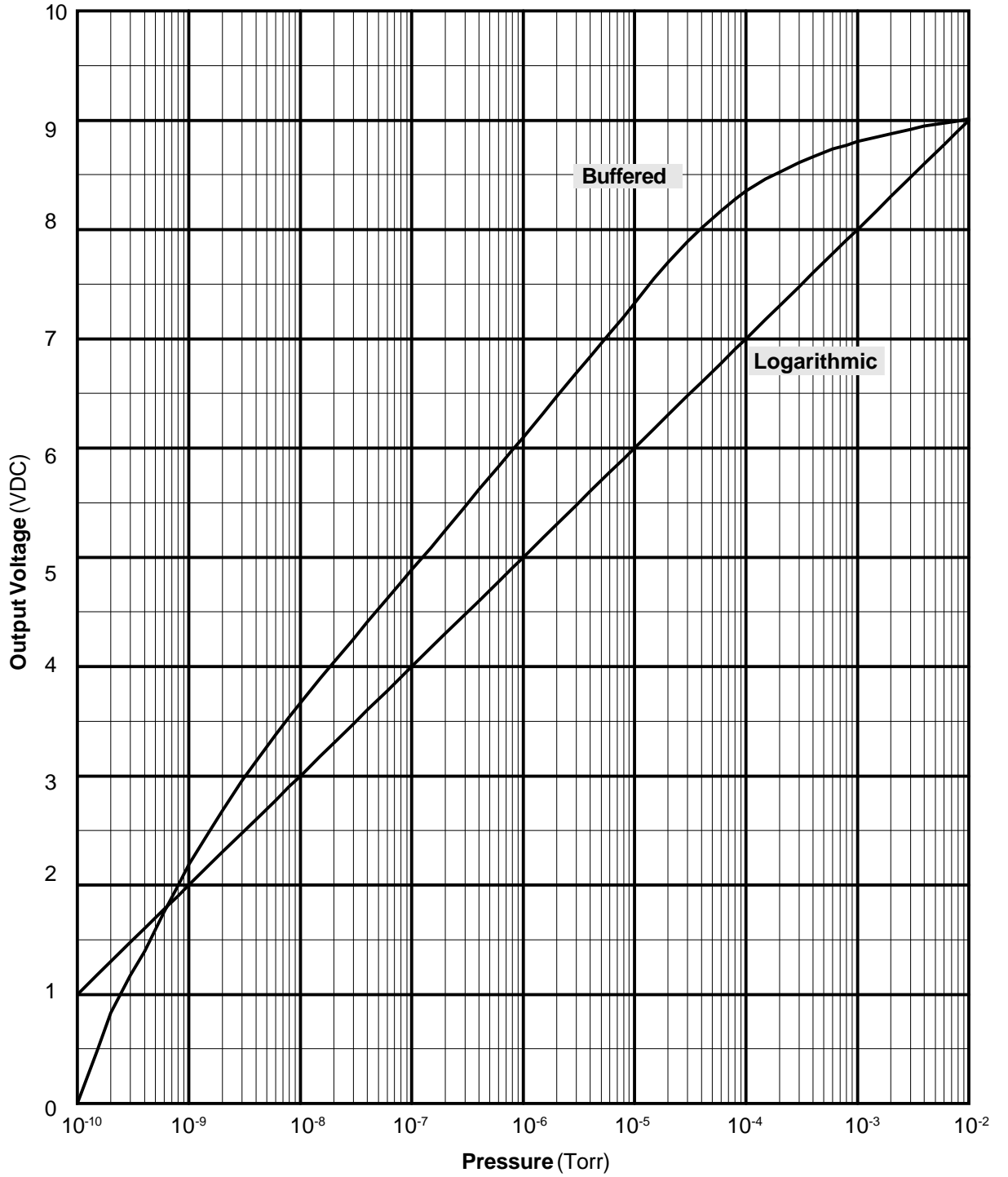

Analog Output, Cold Cathode

Series 943 Cold Cathode System Analog Output Voltage vs. Pressure					
Output Buffered / Logarithmic (V)		Pressure (Torr)	Output Buffered / Logarithmic (V)		Pressure (Torr)
0.00	1.00	1.0E-10	6.10	5.00	1.0E-06
0.48	1.18	1.5E-10	6.31	5.18	1.5E-06
0.83	1.30	2.0E-10	6.47	5.30	2.0E-06
1.17	1.48	3.0E-10	6.69	5.48	3.0E-06
1.39	1.60	4.0E-10	6.83	5.60	4.0E-06
1.76	1.78	6.0E-10	7.05	5.78	6.0E-06
1.99	1.90	8.0E-10	7.20	5.90	8.0E-06
2.19	2.00	1.0E-09	7.32	6.00	1.0E-05
2.48	2.18	1.5E-09	7.55	6.18	1.5E-05
2.68	2.30	2.0E-09	7.69	6.30	2.0E-05
2.95	2.48	3.0E-09	7.89	6.48	3.0E-05
3.13	2.60	4.0E-09	8.01	6.60	4.0E-05
3.38	2.78	6.0E-09	8.17	6.78	6.0E-05
3.54	2.90	8.0E-09	8.27	6.90	8.0E-05
3.67	3.00	1.0E-08	8.35	7.00	1.0E-04
3.89	3.18	1.5E-08	8.46	7.18	1.5E-04
4.04	3.30	2.0E-08	8.52	7.30	2.0E-04
4.25	3.48	3.0E-08	8.61	7.48	3.0E-04
4.41	3.60	4.0E-08	8.66	7.60	4.0E-04
4.62	3.78	6.0E-08	8.73	7.78	6.0E-04
4.77	3.90	8.0E-08	8.77	7.90	8.0E-04
4.88	4.00	1.0E-07	8.80	8.00	1.0E-03
5.09	4.18	1.5E-07	8.85	8.18	1.5E-03
5.25	4.30	2.0E-07	8.88	8.30	2.0E-03
5.46	4.48	3.0E-07	8.92	8.48	3.0E-03
5.62	4.60	4.0E-07	8.94	8.60	4.0E-03
5.83	4.78	6.0E-07	8.97	8.78	6.0E-03
5.98	4.90	8.0E-07	8.99	8.90	8.0E-03
			9.01	9.00	1.0E-02

Set Points

Adjusting the Set Points

To adjust a set point to open or close its relay contact at a particular pressure,

- 1 Depress and hold the *View Set Point* push-button on the front panel for *Set Point 1* or *2*.
- 2 Use a small screwdriver to adjust the corresponding potentiometer until the reading coincides with the desired set point pressure.

When an LED is on, the indicated pressure is below the set point value, the normally open relay contact is closed, and the normally closed contact is open. When an LED is off, the indicated pressure is above the set point value, the normally open relay contact is open, and the normally closed contact is closed.

Protect Set Point

A protect set point turns a sensor off to prevent damage caused by sputtering at high pressures. To adjust the protect set point to turn off the sensor at a particular pressure,

- 1 Depress and hold the *View Protect* push-button on the front panel.
- 2 Use a small screwdriver to adjust its potentiometer until the reading coincides with the desired set point pressure.

If the protect set point turns the high voltage off, **PRO** will appear on the display. Turn off the high voltage switch and then back on again to enable the high voltage.



The protect set point cannot work if the system's pressure is in the sensor's "roll back" pressure region (see Reading Pressure, p. 26).

Using the Series 943 System with Other Gases



Before using the Series 943 Controller to measure pressure of gases other than air or nitrogen, you should read and understand this section. To answer further questions, contact Applications Engineering at HPS™ Products at 1-303-449-9861 or 1-800-345-1967.

In a cold cathode ionization sensor, the degree of ionization, hence the indicated pressure, is gas-type dependent (see **Theory of a Cold Cathode Ionization Sensor**, p. B.1).

The Series 943 System provides analog voltage output for air or nitrogen according to the graph on page 27 or the equation on page 23. If used with another gas, the Controller displays *nitrogen equivalent pressure*, a pressure corresponding to ionization for nitrogen, which may be higher or lower than its true pressure. True-versus-indicated-pressure curves for some common gases are shown below.

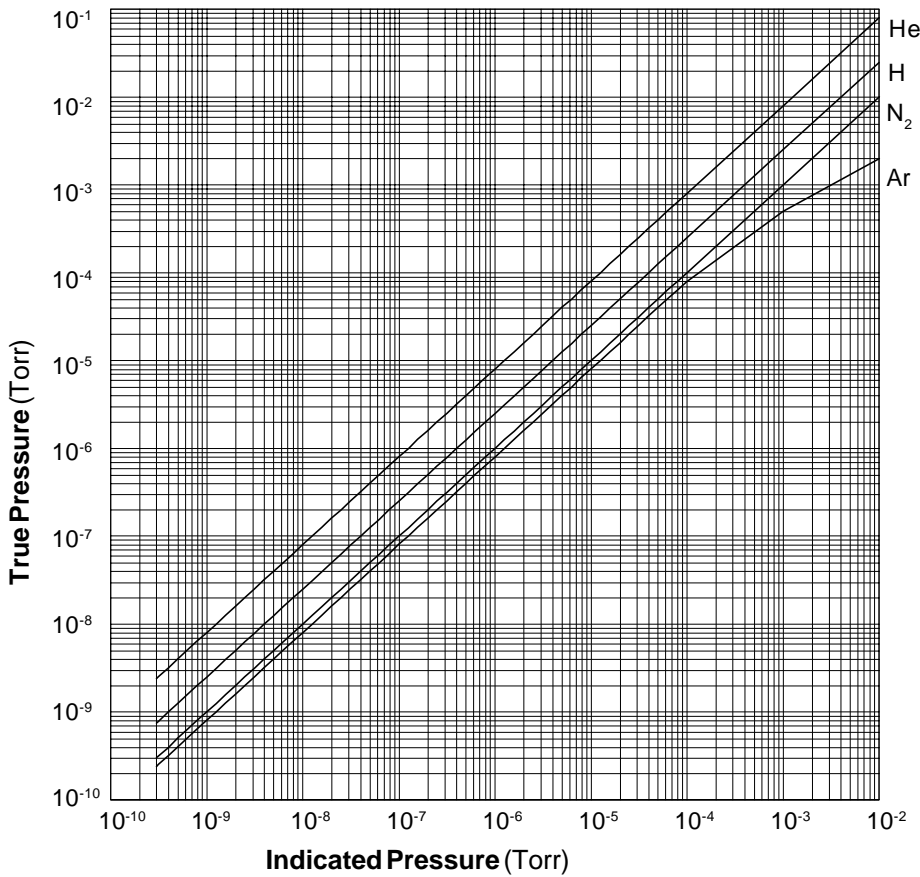

Below is a table which shows the correction factors needed to obtain curves for selected gases other than air/nitrogen. You can make your own graph from this information.

Table of Correction Factors	
$P_{H_2} = P_{\text{Indicated}} \times 2.5$	
$P_{He} = P_{\text{Indicated}} \times 8$	
$P_{Ar} = P_{\text{Indicated}} \times 0.8$ below 10^{-4}	
$P_{Ar} = P_{\text{Indicated}} \times 0.5$ at 10^{-3}	
$P_{Ar} = P_{\text{Indicated}} \times 0.2$ at 10^{-2}	

Calibrating for Other Gases

Air calibration is indistinguishable from nitrogen. To determine the voltage/pressure relationship for a gas which is not shown on the graph, calibrate the Series 943 System for it. This requires a gas independent sensor, such as a capacitance manometer, or a spinning rotor gauge to act as the calibration standard. A curve can then be generated.



The Series 943 Controller cannot be calibrated for direct pressure readings of gases other than air or nitrogen. The calibration is intended only to match the air/nitrogen curve of the sensor.

Gas-type dependence can either be an advantage or a disadvantage. On the one hand, it's possible to use a cold cathode sensor as a leak detector. On the other hand, the pressure indication of a gas may vary by a factor of five or more.



Calibration factors, or relative sensitivity factors, for cold cathode ionization sensors are not the same as those for hot cathode sensors.

Maintaining the Series 943 System

Cleaning the Series 943 Controller Front Panel

The front panel of the Controller is designed to resist many solvents. The casing can be cleaned with water, isopropyl alcohol, or any standard glass cleaner.

 **Do not use acetone on the front panel.**

Troubleshooting and Service

The Series 943 Controller is designed to be maintenance-free under normal operation. If a problem should occur, the following chart lists symptoms, possible causes, and their remedies. With this guide, you should be able to diagnose some problems and correct them. Those which fall outside the scope of this chart are generally not serviceable by the user, and the unit should be returned to HPS™ Products for repair.

Returns

If the Series 943 Controller or its sensor should need repair, call the Customer Service Department at HPS™ Products to obtain an ERA (Equipment Return Authorization) number prior to shipment. Place this number visibly on the outside of the return package.

Please see warranty information on page 36.

Troubleshooting Chart

Symptom	Possible Cause	Remedy
Pressure reading is inaccurate or erratic.	<ol style="list-style-type: none"> 1. Pressure may be above the System's range. 2. External magnetic field may be interfering with sensor operation. 3. Sensor may need cleaning. 4. Controller may be out of calibration. 5. Gas in system may not be air or nitrogen. 	<ol style="list-style-type: none"> 1. Turn off Controller. Do not operate above 10^{-2} Torr. 2. Move magnetic field source away from sensor or vice versa. 3. Rebuild sensor internals (see Accessories, p. 34). 4. Return to MKS for repair. 5. Use a correct conversion factor.
No pressure reading on display.	<ol style="list-style-type: none"> 1. Controller might not be plugged into proper power source. 2. Power switch may be <i>Off</i>. 3. Power fuse(s) may be blown. 4. Power supply may be defective. 	<ol style="list-style-type: none"> 1. Plug into functional AC outlet with the correct voltage. 2. Turn power <i>On</i>. 3. Replace fuse. 4. Return to MKS for repair.
LO is displayed.	<ol style="list-style-type: none"> 1. Ion current or high voltage cable may be disconnected or may have a bad or broken connection. 2. Sensor discharge may not have yet started. 3. Pressure may be below System's range. 4. Pressure may be above System's range. 	<ol style="list-style-type: none"> 1. Check cable connections. Replace cable if necessary. 2. Temporarily backfill to a higher pressure (10^{-4} Torr). 3. The Series 943 Controller is operating normally. 4. Turn high voltage off and set pressure below 10^{-2} Torr.
PRO is displayed.	<ol style="list-style-type: none"> 1. Pressure is above the protect set point. 	<ol style="list-style-type: none"> 1. Change protect set point or reduce system pressure.
Set point relay will not operate.	<ol style="list-style-type: none"> 1. Set point voltage may be incorrectly set. 2. Short in or incorrectly wired <i>Accessory</i> connector. 3. Defective PC board. 	<ol style="list-style-type: none"> 1. Check set point. 2. Rewire connector. 3. Return to MKS for repair.

Accessories

	Part #
Accessory Connector Kit	100005087
Cable for Cold Cathode Sensor	
Series 421	
10 ft (3.0 m)	100006171
25 ft (7.6 m)	100006172
50 ft (15.2 m)	100006173
100 ft (30.5 m)	100006174
Custom to 300 ft (91.4 m)	100006175
Series 423 I-MAG®	
2 ft (0.6 m)	100002505
10 ft (3.0 m)	100007873
25 ft (7.6 m)	100007874
50 ft (15.2 m)	100002395
Custom to 300 ft (91.4 m)	100008759
IgniTorr™ Cold Cathode Starting Device	
(for use with CF flange only)	
120V	100006850
220V	100007090
Internal Rebuild Kit	

Series 421	
Cathode, Washer, Copper Gasket, Abrasive Paper, and	
(6) ¼-28 Socket Head Cap Screws or	100006734
(8) 10-32 Socket Head Cap Screws	100006735
Series 423 I-MAG®	
	100002353
Cathode, Grid Washer, Ground Shield, Ceramic Spacers – 1 Sm and 1 Lrg, Spring	
Mounting Hardware Kit, ¼ DIN	100005021
Power Cord, 115 VAC	103150001
Sensor, Cold Cathode	
Series 421	
KF 25	104210004
KF 40	104210001
2¾" CF	104210002
1" tube	104210003
8 VCR®-F (½")	104210005
Series 423 I-MAG®	
KF 25	104230004
KF 40	104230001
2¾" CF	104230002
1" tube	104230003
HPS™ Products Series 943 Cold Cathode	100009887
Sensor System User's Manual	

Please call the Customer Service Department, HPS™ Products, at 1-303-449-9861 or 1-800-345-1967 to order any of these parts or to receive catalogs for other HPS™ products.

Product Warranty

Extent of the Warranty

MKS Instruments, Inc., HPS™ Products, (MKS), warrants the HPS™ Products Series 943 Digital, Cold Cathode Vacuum Sensor System and its accessories to be free from defects in materials and workmanship for one (1) year from the date of shipment by MKS or authorized representative to the original purchaser (PURCHASER). Any product or parts of the product repaired or replaced by MKS under this warranty are warranted only for the remaining unexpired part of its one (1) year original warranty period. After expiration of the applicable warranty period, the PURCHASER shall be charged HPS™ current prices for parts and labor, plus any transportation for any repairs or replacement.

ALL EXPRESS AND IMPLIED WARRANTIES, INCLUDING THE IMPLIED WARRANTIES OF MERCHANTABILITY AND FITNESS FOR A PARTICULAR PURPOSE, ARE LIMITED TO THE WARRANTY PERIOD. NO WARRANTIES, EXPRESS OR IMPLIED, WILL APPLY AFTER THIS PERIOD.

Warranty Service

The obligations of HPS™ under this warranty shall be at its option: (1) to repair, replace, or adjust the product so that it meets applicable product specifications published by HPS™ or (2) to refund the purchase price.

What Is Not Covered

The product is subject to above terms only if located in the country of the seller from whom the product was purchased. The above warranties do not apply to:

- I. Damages or malfunctions due to failure to provide reasonable and necessary maintenance in accordance with HPS™ operating instructions.
- II. Damages or malfunctions due to chemical or electrolytic influences or use of the product in working environments outside the specification.
- III. Fuses and all expendable items which by their nature or limited lifetime may not function for a year. If such items fail to give reasonable service for a reasonable period of time within the warranty period of the product; they will, at the option of MKS, be repaired or replaced.
- IV. Defects or damages caused by modifications and repairs effected by the original PURCHASER or third parties not authorized in the manual.

Condition of Returned Products

HPS™ will not accept for repair, replacement, or credit any product which is asserted to be defective by the PURCHASER, or any product for which paid or unpaid service is desired, if the product is contaminated with potentially corrosive, reactive, harmful, or radioactive materials, gases, or chemicals.

When products are used with toxic chemicals, or in an atmosphere that is dangerous to the health of humans, or is environmentally unsafe, it is the responsibility of the PURCHASER to have the product cleaned by an independent agency skilled and approved in the handling and cleaning of contaminated materials before the product will be accepted by HPS™ for repair and/or replacement.

In the course of implementing this policy, HPS™ Customer Service Personnel may inquire of the PURCHASER whether the product has been contaminated with or exposed to potentially corrosive, reactive, harmful, or radioactive materials, gases, or chemicals when the PURCHASER requests a return authorization. Notwithstanding such inquiries, it is the responsibility of the PURCHASER to ensure that no products are returned to MKS which have been contaminated in the aforementioned manner.

Other Rights and Remedies

- I. These remedies are exclusive. HPS™ SHALL NOT BE LIABLE FOR CONSEQUENTIAL DAMAGES, FOR ANTICIPATED OR LOST PROFITS, INCIDENTAL DAMAGES OR LOSS OF TIME, OR OTHER LOSSES INCURRED BY THE PURCHASER OR BY ANY THIRD PARTY IN CONNECTION WITH THE PRODUCT COVERED BY THIS WARRANTY, OR OTHERWISE. Some states do not allow exclusion or limitation of incidental or consequential damage or do not allow the limitation on how long an implied warranty lasts. If such laws apply, the limitations or exclusions expressed herein may not apply to PURCHASER.
- II. Unless otherwise explicitly agreed in writing, it is understood that these are the only written warranties given by HPS™. Any statements made by any persons, including representatives of HPS™, which are inconsistent or in conflict with the terms of the warranty shall not be binding on HPS™ unless reduced to writing and approved by an authorized officer of HPS™.
- III. This warranty gives PURCHASER specific legal rights, and PURCHASER may also have other rights which vary from state to state.
- IV. For HPS™ products sold outside of the U.S., contact your HPS™ representative for warranty information and service.

Warranty Performance

To obtain warranty satisfaction, contact the following: MKS Instruments, Inc., HPS™ Products Inc., 5330 Sterling Drive, Boulder, CO 80301, USA, at phone number (303) 449-9861. You may be required to present proof of original purchase.

Notes



Appendix A: Installing a Series 943 System Sensor



The Series 943 Controller must be turned off before connecting or disconnecting a sensor cable from the sensor or Controller.

Locating a Cold Cathode Sensor

Locate a cold cathode sensor where it can measure process chamber or manifold pressure. Install it away from pumps, vibration sources, and gas sources to give the most representative values.

Locate and orient a cold cathode sensor where contamination is least likely. If it is installed directly above a diffusion pump, for example, oil vapor could contaminate the cathode, anode, or other vacuum exposed parts, causing the calibration to shift.

If a low vacuum sensor, such as a Pirani sensor, is used to disable the cold cathode sensor remotely, locate it closely to the cold cathode sensor.

Orienting a Cold Cathode Sensor

A cold cathode sensor can be installed in any operating position without affecting accuracy. Installing it with the vacuum port facing down is best as this helps prevent contaminants falling into it.

Managing Contamination in a Cold Cathode Sensor

If pressure readings appear to be erratic, the Sensor may be contaminated. Inspect it visually. If contamination is visible (e.g., discoloration of the aluminum cathode), replace the internal components with an Internal Rebuild Kit (see **Accessories**, p. 34).

Depending on the degree of contamination and application of the Sensor, the internal parts may be cleaned — either ultrasonically, with mild abrasives, or chemically.

Operation at pressures above 10^{-3} Torr for extended periods can increase the likelihood of contamination.

Testing a Cold Cathode Sensor

HPS™ cold cathode sensors contain the anode and cathode (collector) electrodes. Test the sensor with an ohmmeter. There should be no shorts between the electrodes or from the electrodes to the tube body.

Connecting a Cold Cathode Sensor

Mount the sensor to a grounded vacuum system. Use a conductive, all-metal clamp to mount a KF 25 or KF 40 flanged sensor body.

If the Series 423 I-MAG® Sensor has a CF flange, remove the magnet first to allow clearance for bolt installation.



The Series 423 Sensor has a strong magnetic field. Be careful when using it around tools and other equipment.

When replacing the magnet, note that it is keyed to the sensor body to protect the feedthrough pins from damage. The pins should be straight and centered.

A cold cathode sensor and the Series 943 Controller are connected to one another with coaxial cables with SHV and SMA connectors.

Connect the cable to the sensor and to the Series 943 Controller before turning on your system. On the I-MAG, tighten the thumb screw on top of the cable to make sure it is securely in place for strain relief.

Connect the SHV and SMA connectors to their respective connectors on the rear panel of the Controller – H.V. (SHV connector) and Ion Current (SMA connector).

Where stress might be applied to the cable, use separate strain relief to avoid damage to the sensor, cable, or the Controller. Cables are available from the factory in standard lengths of 10, 25, 50, and 100 feet and in custom lengths up to 300 ft.

Some applications may require the use of special cables, such as where the connection must be routed through restrictive barriers or through a conduit. Custom cables may be fabricated for these situations. Use SHV and SMA connectors for all applications.



For the following section, please refer to the figure shown on page A.4.

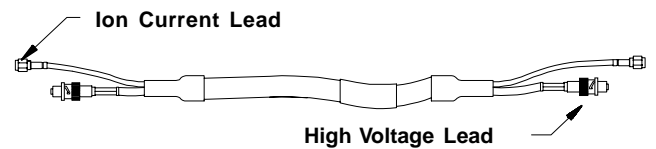

Series 421

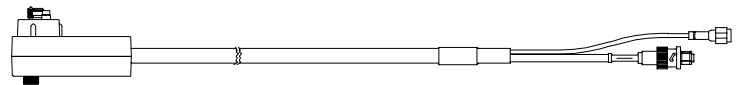

Series 423

Cold cathode sensor cables

Series 423 I-MAG[®] Cold Cathode Sensor

Disassembling the I-MAG Sensor

Tools required: clean tweezers; clean smooth-jaw, needle-nose pliers

- 1 Loosen the thumb screw on top of the sensor cable and remove it.
- 2 Remove the two *flat head screws* 15 .
- 3 Remove the *magnet* 14 .
- 4 Using the smooth-jaw, needle-nose pliers, firmly grab the *compression spring* 1 at the tip closest to the flange.
- 5 Pull on the *compression spring* while rotating it to free it from the formed groove of the *sensor body* 7 . Continue to pull until the *compression spring* is completely free.
- 6 Carefully remove the remaining components (2 through 6) from the *sensor body*.



Do not bend the *anode* 8 or the *leaf spring* 9 on the *ion current feedthrough pin* 13 when assembling or disassembling the Sensor as they are very fragile and could break.

Cleaning the I-MAG Sensor

If **ultrasonic cleaning**, use high quality detergents compatible with aluminum, such as ALCONOX[®].

Scrubbing with mild abrasives can remove most contamination. Scotch-Brite[™] or a fine emery cloth may be effective. Rinse with alcohol.

Clean aluminum and ceramic parts chemically in a wash, such as a 5 to 20% sodium hydroxide solution (not for semiconductor processing), at room temperature (20°C) for one minute. Follow with a preliminary rinse of deionized water. Remove smut (the black residue left on aluminum parts) in a 50 to 70% nitric acid dip for about 5 minutes.

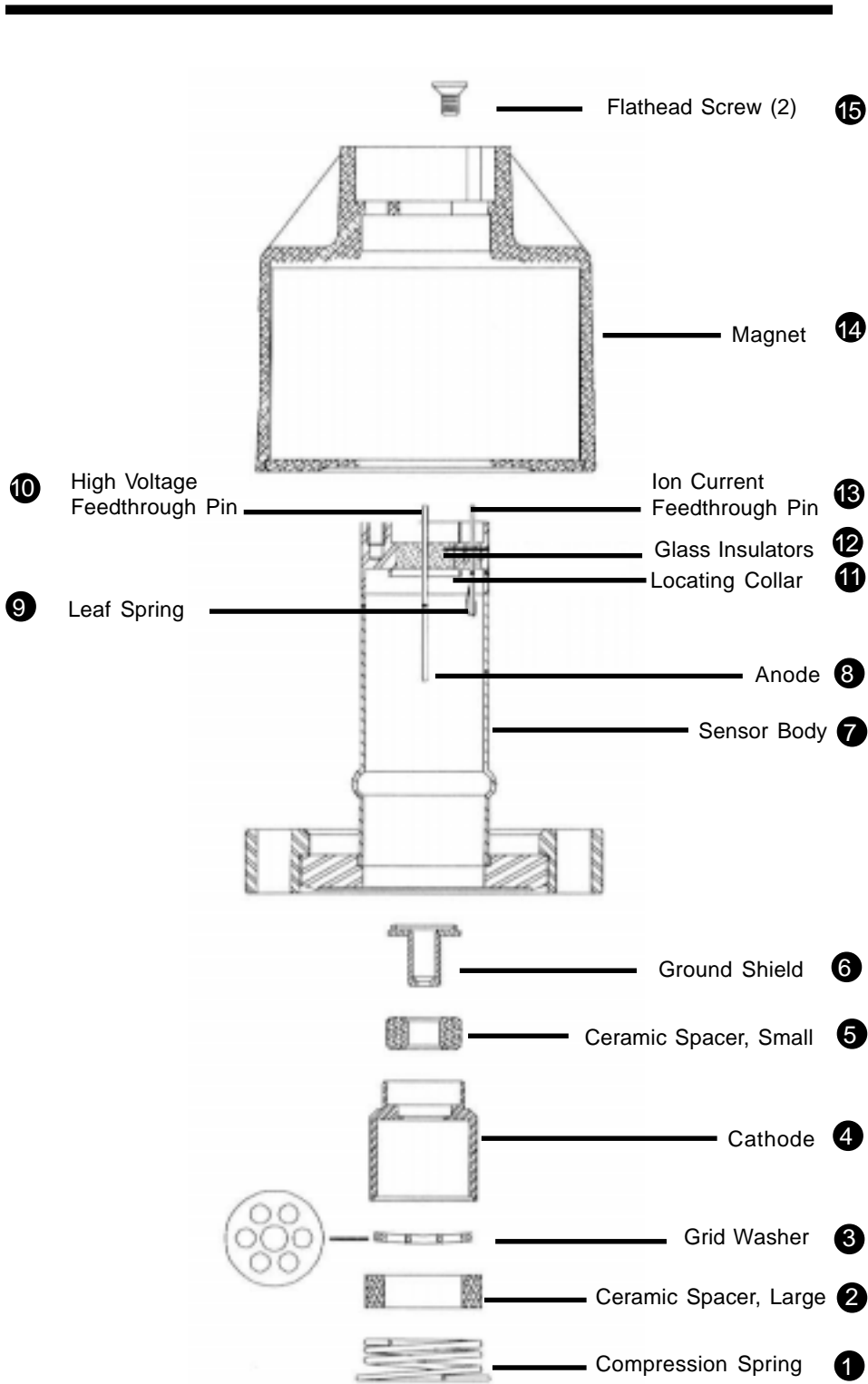

Series 423 I-MAG® Sensor, exploded view



Chemical cleaning should not be used to clean the *anode* 8; mild abrasives or ultrasonic cleaning are acceptable.



Do not damage the *leaf spring* 9 while cleaning the Sensor.

Each of the above cleaning methods should be followed with multiple rinses of deionized water.

Dry all internal components and the *sensor body* 7 in a clean oven. The two *ceramic spacers*, 2 and 5 are slightly porous and will require longer drying time in the oven to drive off the absorbed water.

Assembling the I-MAG Sensor

Wear gloves and assemble with clean tools.

- 1 Roll the *sensor body* on a flat surface and check the *anode* 8 for any radial runout motion. It should be straight and centered with the *sensor body* 7 for proper operation.
- 2 Install the *ground shield* 6 using tweezers. Make sure that the large diameter of the *ground shield* interlocks with the *locating collar* 11.
- 3 Slide the *small ceramic spacer* 5 over the small end of the *ground shield* 6.
- 4 Check that the *leaf spring* 9 will contact the base of the *cathode* 4 as shown to the left. If not, remove the *small ceramic spacer* and the *ground shield*, and gently bend the *leaf spring* towards the *anode* 8 and then replace the *ground shield* and *ceramic spacer*.
- 5 Slide the *cathode* 4, the *grid washer* 3, and the *large ceramic spacer* 2 into place. The *grid washer* has a concave shape. Refer to the figures for its installation orientation.
- 6 Insert the small end of the *compression spring* 1 into the *sensor body* 7. Use your thumbs to push the large end in.
- 7 Using the smooth-jaw, needle-nose pliers, work the *compression spring* down into the *sensor body* until the large end is fully seated in the formed groove.
- 8 Inspect the *ground shield* 6 and the *grid washer* 3 to verify they are centered with respect to the *anode* 8.
- 9 If adjustment is needed, gently reposition the grid washer/ cathode assembly, taking care not to scratch the *grid washer*.

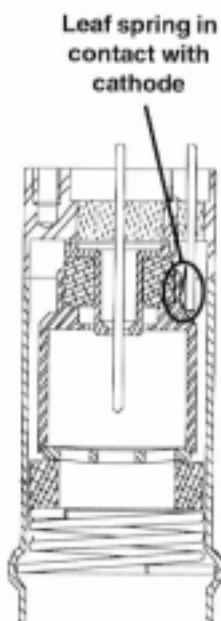



We suggest you measure the resistance between the *ion current feedthrough pin* 13 and the *grid washer* 3 to verify that the *leaf spring* 9 is in contact with the *cathode* 4. The measurement should indicate a short circuit between them. There should be an open circuit between the *ion current feedthrough pin* 13 and both the *high voltage feedthrough pin* 10 and *sensor body* 7.

The I-MAG Sensor is ready for installation. If it is not immediately installed, cover the flange with clean, vacuum grade aluminum foil and cap it with a flange protector.

Preparing the Sensor for Bakeout

Locate the thumbscrew on top of the cable and remove it. Unscrew the two flathead screws located on top of the Sensor, and then remove the magnet. The remainder of the Sensor is ready to be baked out to 500°C if using a CF flange or to 150°C if using a KF flange.



For the following section, please refer to the figure shown on page A.7.

Series 421 Cold Cathode Sensor

Disassembling the Series 421 Sensor

The Sensor breaks down into three subassemblies – the backshell, internal, and the body subassemblies. Only the internal and body subassemblies are exposed to vacuum.

To disassemble the Sensor, remove the backshell subassembly as follows (Steps 1 through 4 are not necessary when replacing internal parts):

- 1 Remove the two 4-40 x 1/4" Phillips head SEMS screws 2 and slide the *backshell* 9 off the sensor.
- 2 Remove the two 4-40 x 1/4" button head screws 1.
- 3 Use needle nose pliers to pull the #22 contact 8 off of the *ion current feedthrough* 17.
- 4 Pull the #20 contact 1 off of the 5kV feedthrough 12 taking the entire *bulkhead* 4 with it (do not remove the SHV and SMA connectors from the bulkhead).

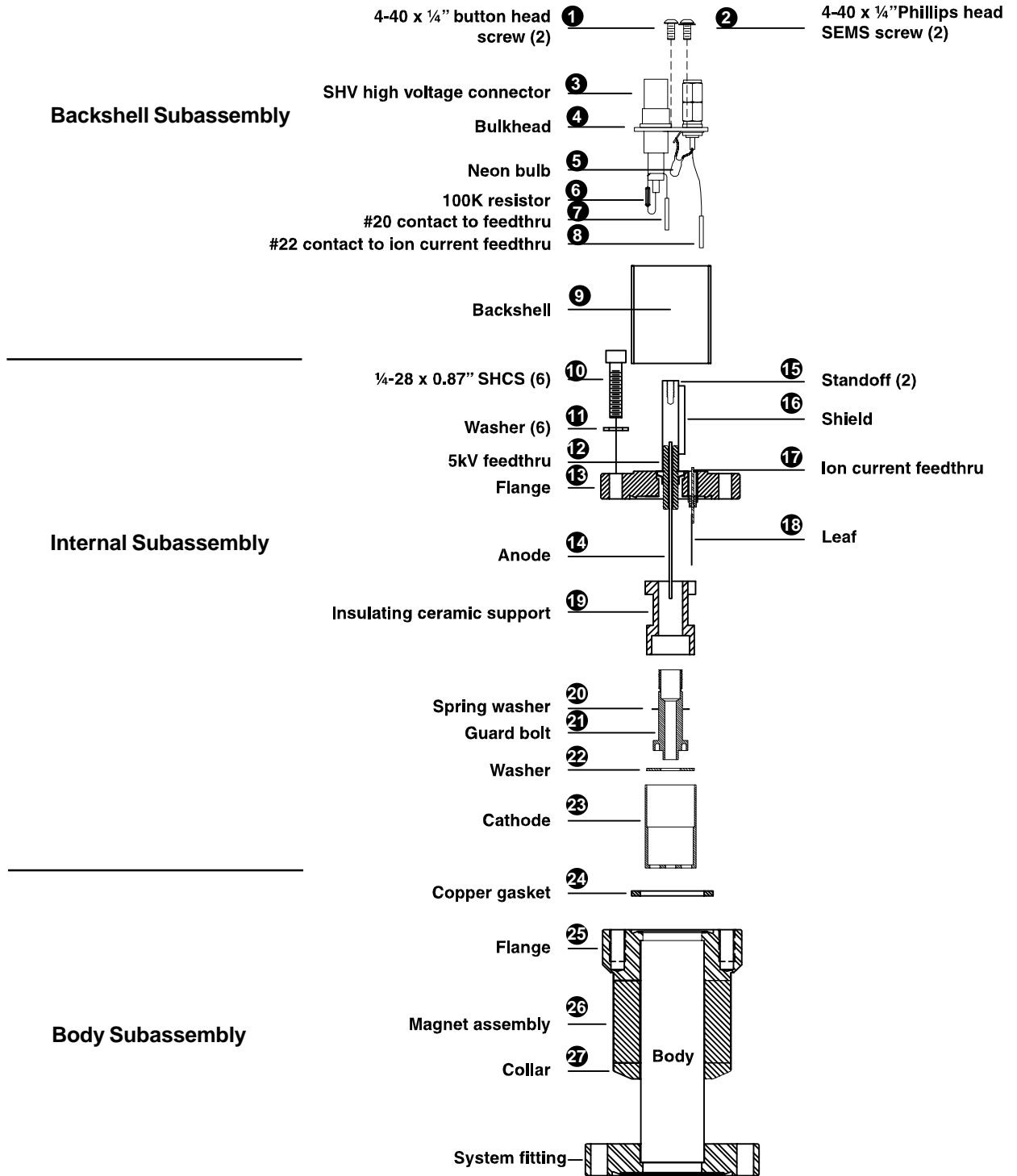

Series 421 Cold Cathode Sensor, exploded view of backshell, internal, and body subassemblies

-
- 5 Remove the six $\frac{1}{4}$ -28 x 0.87" (eight 10-32) *socket head cap screws* 10 and pull the back *flange* 13 free. Note that these screws are silver-plated for lubricity and should be used only once. They may be relubricated with a dry lubricant such as molybdenum disulfide, though new silver-plated screws are recommended. The *copper gasket* 13 must be replaced.

The cathode and anode assemblies are attached to the back *flange*. Here disassembly generally proceeds from bottom to top of the internal assembly drawing.

- 6 To remove the *cathode* 23, release the two integral, spring-loaded ears hooked over the shoulder of the *ceramic insulating support* 19.
- 7 Gently pull up on the ear until it just clears the outer diameter of the *insulating support*.
- 8 Slide the *cathode* and *washer* 22 off the *insulating support*.

Note the position of the small Elgiloy® *leaf* 18 used to connect the *ion current feedthrough* 17 to the *cathode*. Rotational position of the *cathode* with respect to the *leaf* is not critical, but take care to not bend the *leaf*.

- 9 The *insulating support* is captured by the *guard bolt* 21. Remove with a wrench and unscrew the *guard bolt* from the *flange* 13.

Note the presence of the small curved *spring washer* 20 under the head of the *guard bolt*. The *spring washer* holds the *insulating support* tight, preloads the *guard bolt* to resist unscrewing due to possible system vibration, and provides compliance for differential thermal expansion during bakeout.

Cleaning the Series 421 Sensor

This procedure is the same as for the Series 423 I-MAG Cold Cathode Sensor (see p. A.3).

Assembling the Series 421 Sensor

To reassemble, reverse the order used during disassembly. Note the following special tightening procedure of the *guard bolt*. The *bolt* has a $\frac{3}{8}$ "-40 thread which is delicate.

- 1 Finger tighten the *guard bolt* to compress the *spring washer*. Then back off tightness by a $\frac{1}{2}$ turn. Do not overtighten as this will remove all compliance from the *spring washer* and possibly damage the aluminum thread.

-
- 2 Verify that the *anode* ⑭ is well-centered within the bore of the *guard bolt*. If it is not, bend it back into position and continue with standard assembly.

Preparing the Sensor for Bakeout

To prepare the Sensor for bakeout up to 125°C, remove the high voltage and ion current cables only.

To prepare the Sensor for bakeout up to 250°C, also remove the backshell and bulkhead subassembly shown on page A.7. Follow steps 1 through 4 of **Disassembling the Series 421 Sensor** on page A.6.

Notes

Appendix B: How the Series 943 System Works

Theory of a Cold Cathode Ionization Sensor

In a cold cathode sensor, gas molecules are ionized by a high voltage discharge of electrons. Sensitivity is enhanced by a magnetic field.

HPS™ Products Group cold cathode sensors are not standard Penning sensors. The inverted magnetron design includes an isolated collector, making the sensor less susceptible to contamination and allowing a wider range of pressure measurement. The HPS™ Products IgniTorr™, an optional cold cathode starting device initiates the ionization process in cold cathode sensors, starting UHV pressure readings in seconds (see **Accessories**, p. 34).

A cold cathode ionization sensor has a number of inherent advantages over a hot cathode sensor. These include:

- ◆ No filament to break or burn out, which makes it immune to inrushes of air, and it is relatively insensitive to vibration damage
- ◆ No x-ray limit for lower pressure measurement
- ◆ No adjustment for emission current or filament voltage is needed
- ◆ Degassing is not needed
- ◆ Properly designed sensor tubes can be cleaned and reused almost indefinitely
- ◆ With only one current loop, the control circuit is simple and quite reliable, as opposed to a hot cathode sensor, which has three.

The cold cathode sensor consists of a cathode and anode with a potential difference of several kilovolts. (Refer to the drawing on the next page.) The electrodes are surrounded by a magnet, arranged so that the magnetic field is essentially perpendicular to the electric field. The crossed electric and magnetic fields cause the electrons to follow long spiral trajectories increasing the chance of collisions with gas molecules, thereby providing a significant increase in ionization efficiency relative to a hot cathode sensor.

In operation, a near constant circulating electron current is trapped by the crossed fields. Collisions of electrons with residual gas molecules

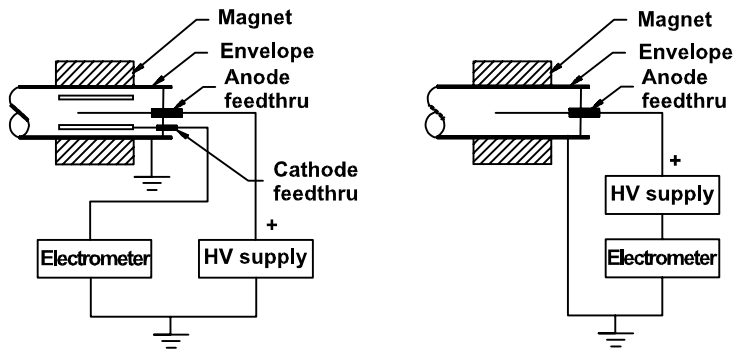

Inverted magnetron, cold cathode sensor design

produce ions which are collected by the cathode. The sensor current i as a function of pressure P obeys the relationship,

$$i = kP^n$$

where,

i is in amperes

k is a constant

P is in Torr

n is a constant, usually in the range of 1.00 to 1.15.

This equation is valid for the pressure range from 10^{-3} Torr down to 10^{-8} Torr depending upon the series resistor used. At pressures around 10^{-6} Torr, sensitivities of 1 to 10 A/Torr are not unusual.

Starting a cold cathode sensor depends upon some chance event such as field emission or a cosmic ray producing the first electron. This produces additional electron/ion pairs during its transit between the electrodes, and the discharge soon builds up to a stable value. Start of the discharge normally requires a very short time at 10^{-6} Torr or above, a few minutes at 10^{-8} Torr, and longer times at lower pressures.

At high pressures, the current increases, and sputtering of the cathode can become a problem. A large series resistor reduces sputtering, and the voltage across the tube is pressure dependent between 10^{-4} and 10^{-2} Torr. This extends the measuring range of the cold cathode to 10^{-2} Torr.

Many electrode arrangements have been used in cold cathode sensors. Single feedthrough cold cathode sensors often suffer from

spurious currents due to insulator leakage and field emission, which mask the small pressure dependent ionization currents.

Because of the difficulty in maintaining the discharge at low pressures, sensors of the loop anode design do not work well below 10^{-6} Torr. To reduce this problem, a cylindrical anode, cathode plates at each end, and a cylindrical magnet are used. During the 1950s, the inverted magnetron sensor was developed, which uses auxiliary cathodes and is able to measure pressures below 10^{-12} Torr.

HPS™ Vacuum Products Group cold cathode sensors use an inverted magnetron with separate feedthroughs for the anode high voltage and the cathode current. This geometry uses a cylindrical cathode, a central wire anode, and external cylindrical magnet which provides an axial field. The cathode is insulated from the grounded metal housing.

The inverted magnetron geometry has a characteristic *electrical conductance vs. pressure* curve which is more reproducible than other arrangements, and also works well to low pressures without risk of the discharge going out.

Series 943 Circuit Description

This section is intended to give the reader an overview of the internal workings of the Series 943 Controller. This manual does not provide detail to allow component level troubleshooting of the instrument. Refer to the figure on the following page, the Controller block diagram, while reading this section. The Series 943 Controller is an analog instrument which has four basic circuits to control the cold cathode sensor and uses signals from the sensor to display pressure, operate the set point relays, and supply analog voltage-vs.-pressure outputs.

High Voltage Power Supply

The high voltage power supply is a DC to DC voltage converter. This circuit requires very few components, which ensures high reliability, and is closed loop controlled to a reference voltage to provide a very stable high voltage output. The high voltage output is connected to the sensor through a series resistor which limits the current through the sensor at high pressures to about 100 mA, thereby reducing internal sputtering of the discharge cell.

Electrometer

The electrometer performs a logarithmic conversion to measure the sensor tube's current and high voltage. This electrometer has a dynamic range wide enough to cover the entire pressure range with no electronic range changing.

Analog Processing

The processing circuitry combines the electrometer signals and scales the result to produce a pressure dependent voltage signal. This voltage drives the A/D converter, unprocessed analog output, and the set point relay circuitry.

Set Point Comparators

This part of the circuit compares the output of the signal processing circuitry to the value of the set point adjusting potentiometers and turns the process control relays on and off accordingly.

Microprocessor

This part of the circuit reads the output of the A/D converter, displays pressure on the LED display, and produces a pressure dependent voltage signal using a D/A converter.

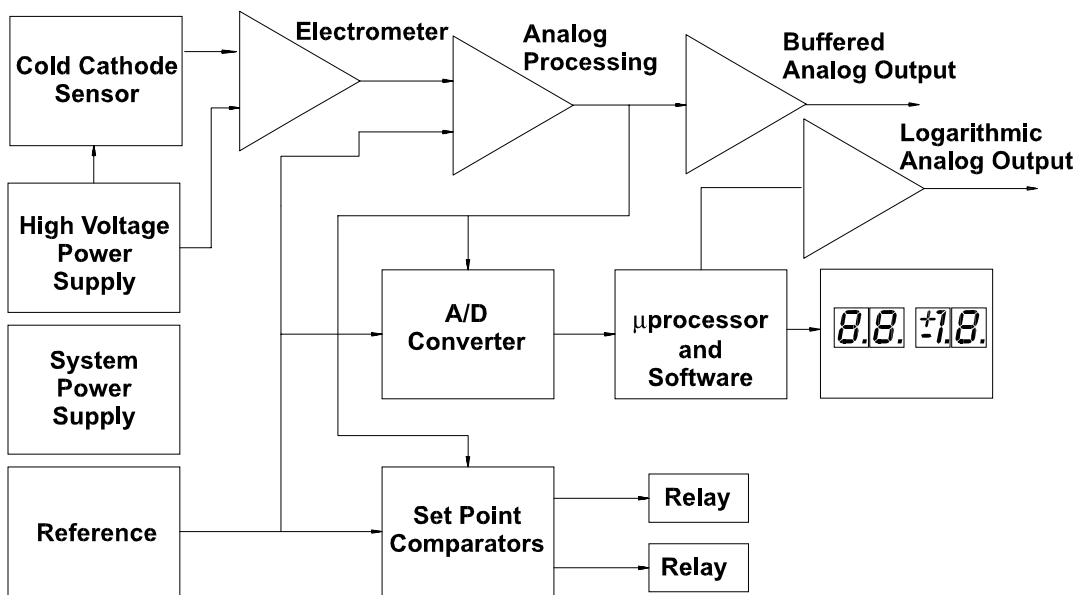

Series 943 Controller block diagram

Notes



